



UniFi[®] | AP AC

Enterprise WiFi System

Model: UAP-AC

QUICK START GUIDE

Introduction

Thank you for purchasing the Ubiquiti Networks® UniFi® Enterprise WiFi System. This system includes the UniFi Controller software, which allows you to manage your wireless network using a web browser. The software and User Guide are available for download at: downloads.ubnt.com/unifi This Quick Start Guide includes the warranty terms and is for use with the UniFi AP-AC, model UAP-AC.

Package Contents



UniFi AP AC



Mounting Bracket



Ceiling Backing Plate



Flat Head Screws
(M3x50, Qty. 4)



Keps Nuts
(M3, Qty. 4)



Screws
(M2.9x20, Qty. 4)



Screw Anchors
(M3x20, Qty. 4)



Gigabit PoE Adapter
(48V, 0.5A Gigabit)



Power Cord



Quick Start Guide

Installation Requirements

- CAT5/6 cable
- Phillips screwdriver
- Drill and drill bit (6 mm for wall-mounting or 3 mm for ceiling-mounting)
- Optional: Drywall or keyhole saw (to cut 25 mm hole for Ethernet cable feed)

TERMS OF USE: All Ethernet cabling runs must use CAT5 (or above). It is the customer's responsibility to follow local country regulations, including operation within legal frequency channels, output power, indoor cabling requirements, and Dynamic Frequency Selection (DFS) requirements.

System Requirements

- Microsoft Windows 7/8, Mac OS X, or Linux
- Java Runtime Environment 1.6 (or above)
- Web Browser: Mozilla Firefox, Google Chrome, or Microsoft Internet Explorer 8 (or above)

Network Topology Requirements

- A DHCP-enabled network (for the AP to obtain an IP address as well as for the wireless clients after deployment)
- A management station running the UniFi Controller software, located either on-site and connected to the same Layer-2 network, or off-site in a cloud or NOC

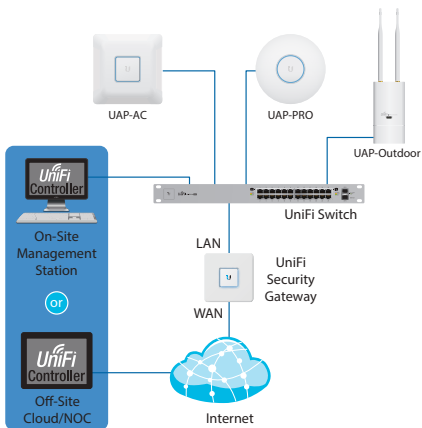

Sample Network Diagram

All UniFi devices support off-site management controllers. For setup details, see the User Guide on the website: documentation.ubnt.com/unifi

Hardware Overview

LED



LED Color	Status
White	Factory default, waiting to be integrated.
Flashing White	Initializing.
Alternating White/Blue	Device is busy; do not touch or unplug it. This usually indicates that a process such as a firmware upgrade is taking place.
Blue	Indicates the device has been successfully integrated into a network and is working properly.
Quickly Flashing Blue	This is used to locate an AP. When you click Locate in the UniFi Controller software, the AP will flash. It will also display the location of the AP on the map.
Steady Blue with occasional flashing	Indicates the device is in an isolated state (all WLANs are brought down until an uplink is found).

Ports

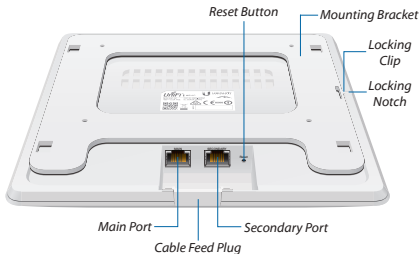

Main The *Main* port is a Gigabit Ethernet port used to connect the power and should be connected to the LAN and DHCP server. Power can be provided by either of the following:

- *Gigabit PoE Adapter* (included)
- Ubiquiti Networks UniFi Switch

Secondary The *Secondary* port is a Gigabit Ethernet port used for bridging.

Reset The *Reset* button serves two functions for the UniFi AP:

- **Restart** Press and release the *Reset* button quickly.
- **Restore to Factory Default Settings** Press and hold the *Reset* button for more than five seconds.

Locking Clip During installation, the *Locking Clip* on the *Mounting Bracket* locks into the *Locking Notch* on the UniFi AP to help prevent theft.

Cable Feed Plug If your Ethernet cable feeds along the mounting surface, remove the *Cable Feed Plug*.

Hardware Installation

The UniFi AP can be mounted on the wall or ceiling. Perform the steps for the appropriate installation:

Wall Mount

1. Position the *Mounting Bracket* at the desired location on the wall with the cable feed slot pointed towards the floor.
2. Use a pencil to mark the four mounting holes. Use a 6 mm drill bit to drill the mounting holes.

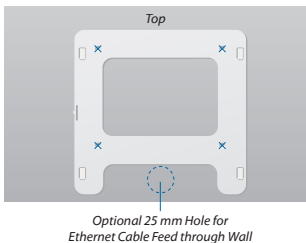

3. Follow the instruction for your type of Ethernet cable feed:
 - **Feeds Through the Wall** Cut or drill a circle approximately 25 mm in diameter, just below the bottom center of the *Mounting Bracket* (as shown above). Then feed the CAT5/6 cable through the hole.
 - **Feeds Along the Mounting Surface** Remove the *Cable Feed Plug* on the side of the UniFi AP.



640-00076-04

4. Insert the *Screw Anchors* into the 6 mm holes. Secure the *Mounting Bracket* to the wall by inserting the *Screws* into the anchors.

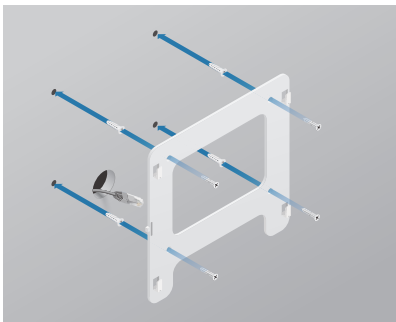

5. Connect the Ethernet cable to the *Main* port. If the feed is along the mounting surface, feed the cable through the *Cable Feed* of the UniFi AP.

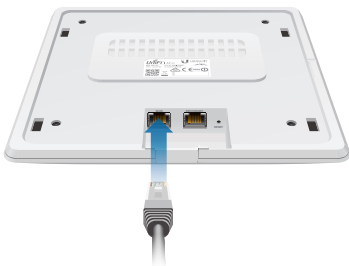

6. Align the slots on the UniFi AP with the tabs on the *Mounting Bracket*.

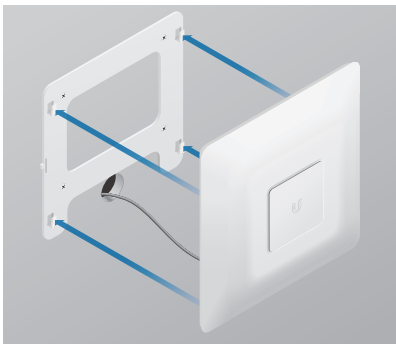

7. Slide the UniFi AP down until it locks into place.

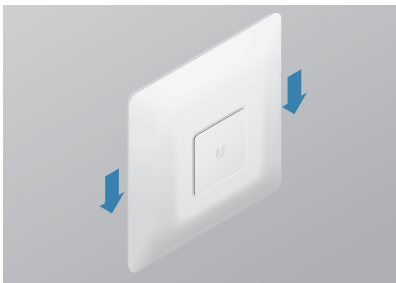

Ceiling Mount

1. Remove the ceiling tile.
2. Place the *Ceiling Backing Plate* in the center of the ceiling tile. Mark the four mounting screw holes and 25 mm hole for the Ethernet cable feed.

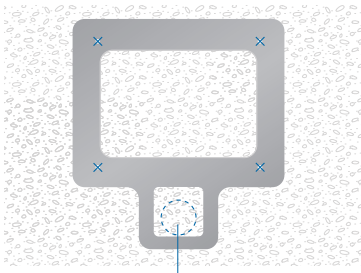

25 mm Hole for Ethernet Cable Feed

3. Use a 3 mm drill bit to drill the screw holes, and cut or drill the hole for the Ethernet cable feed.

4. Secure the *Mounting Bracket* to the ceiling tile using the *Ceiling Backing Plate*, *Flat Head Screws*, and *Keeps Nuts*. Then feed the Ethernet cable through the 25 mm hole.

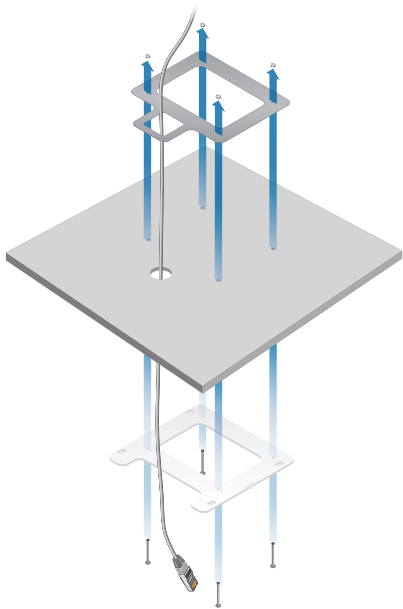

5. Set the ceiling tile back into place.
6. Connect the Ethernet cable to the *Main* port.

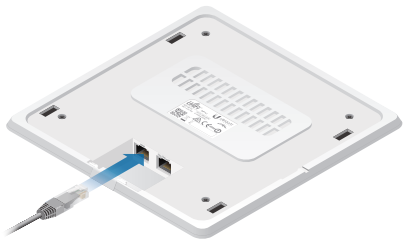

7. Align the slots on the UniFi AP with the tabs on the *Mounting Bracket*.

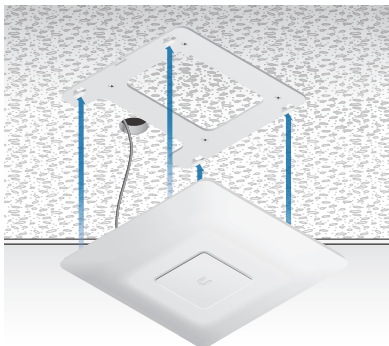

8. Slide the UniFi AP down until it locks into place.



Powering the UniFi AP

The UniFi AP can be powered directly by the Ubiquiti Networks UniFi Switch or with the included *Gigabit PoE Adapter*.

Connecting to a UniFi Switch

Connect the other end of the Ethernet cable coming from the *Main* port on the UniFi AP directly to a PoE+ port on the UniFi Switch.

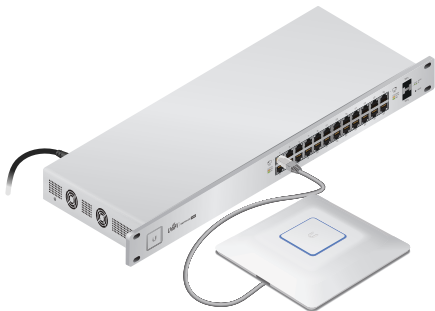

UniFi Switch Power Connection Diagram

Connecting to the PoE Adapter

1. Connect the other end of the Ethernet cable coming from the *Main* port on the UniFi AP to the Ethernet port labeled **POE** on the *Gigabit PoE Adapter*.

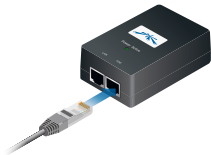

2. Connect an Ethernet cable from your LAN to the Ethernet port labeled **LAN** on the *Gigabit PoE Adapter*.



3. Connect the power cord to the power port on the *Gigabit PoE Adapter*. Connect the other end of the power cord to a power outlet.

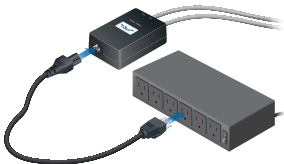

Software Installation

Download and install the latest version of the UniFi Controller software at: downloads.ubnt.com/unifi

Launch the software and follow the on-screen instructions. Step-by-step instructions are available in the User Guide located on our website: documentation.ubnt.com/unifi

After you have installed the software and run the UniFi Installation Wizard, a login screen will appear for the UniFi Controller management interface. Enter the Admin Name and Password that you created and click **Login**.



You can manage your wireless network and view network statistics using the UniFi Controller management interface. For information on configuring and using the UniFi Controller software, refer to the User Guide.

Specifications

UniFi AP-AC (UAP-AC)	
Dimensions	200 x 204 x 27 mm (7.87 x 8.03 x 1.06")
Weight	508 g (566 g with Mounting Kits) 1.12 lb (1.25 lb with Mounting Kits)
Networking Interface	(2) 10/100/1000 Ethernet Ports
Buttons	Reset
Antennas	
2.4 GHz	3 Integrated (Supports 3x3 MIMO with Spatial Diversity)
5 GHz	3 Integrated (Supports 3x3 MIMO with Spatial Diversity)
Wi-Fi Standards	802.11 a/b/g/n/ac
Power Method	48V Passive POE or UniFi Switch
Power Supply	48V, 0.5A PoE Gigabit Adapter (Included)
Max. Power Consumption	22W
Max. TX Power	
2.4 GHz	23 dBm
5 GHz	23 dBm
BSSID	Up to Four per Radio
Power Save	Supported
Wireless Security	WEP, WPA-PSK, WPA-TKIP, WPA2 AES, 802.11i
Certifications	CE, FCC, IC
Mounting	Wall/Ceiling (Kits Included)
Operating Temperature	-10 to 55° C (14 to 131° F)
Operating Humidity	5 to 80% Noncondensing

Safety Notices

1. Read, follow, and keep these instructions.
2. Heed all warnings.
3. Only use attachments/accessories specified by the manufacturer.



WARNING: Do not use this product in location that can be submerged by water.



WARNING: Avoid using this product during an electrical storm. There may be a remote risk of electric shock from lightning.

Electrical Safety Information

1. Compliance is required with respect to voltage, frequency, and current requirements indicated on the manufacturer's label. Connection to a different power source than those specified may result in improper operation, damage to the equipment or pose a fire hazard if the limitations are not followed.
2. There are no operator serviceable parts inside this equipment. Service should be provided only by a qualified service technician.
3. This equipment is provided with a detachable power cord which has an integral safety ground wire intended for connection to a grounded safety outlet.
 - a. Do not substitute the power cord with one that is not the provided approved type. Never use an adapter plug to connect to a 2-wire outlet as this will defeat the continuity of the grounding wire.
 - b. The equipment requires the use of the ground wire as a part of the safety certification, modification or misuse can provide a shock hazard that can result in serious injury or death.
 - c. Contact a qualified electrician or the manufacturer if there are questions about the installation prior to connecting the equipment.
 - d. Protective earthing is provided by Listed AC adapter. Building installation shall provide appropriate short-circuit backup protection.
 - e. Protective bonding must be installed in accordance with local national wiring rules and regulations.

Limited Warranty

UBIQUITI NETWORKS, Inc (“UBIQUITI NETWORKS”) warrants that the product(s) furnished hereunder (the “Product(s)”) shall be free from defects in material and workmanship for a period of one (1) year from the date of shipment by UBIQUITI NETWORKS under normal use and operation. UBIQUITI NETWORKS’ sole and exclusive obligation and liability under the foregoing warranty shall be for UBIQUITI NETWORKS, at its discretion, to repair or replace any Product that fails to conform to the above warranty during the above warranty period. The expense of removal and reinstallation of any Product is not included in this warranty. The warranty period of any repaired or replaced Product shall not extend beyond its original term.

Warranty Conditions

The above warranty does not apply if the Product:

- (I) has been modified and/or altered, or an addition made thereto, except by Ubiquiti Networks, or Ubiquiti Networks’ authorized representatives, or as approved by Ubiquiti Networks in writing;
- (II) has been painted, rebranded or physically modified in any way;
- (III) has been damaged due to errors or defects in cabling;
- (IV) has been subjected to misuse, abuse, negligence, abnormal physical, electromagnetic or electrical stress, including lightning strikes, or accident;
- (V) has been damaged or impaired as a result of using third party firmware;
- (VI) has no original Ubiquiti MAC label, or is missing any other original Ubiquiti label(s); or
- (VII) has not been received by Ubiquiti within 30 days of issuance of the RMA.

In addition, the above warranty shall apply only if: the product has been properly installed and used at all times in accordance, and in all material respects, with the applicable Product documentation; all Ethernet cabling runs use CAT5 (or above), and for outdoor installations, shielded Ethernet cabling is used, and for indoor installations, indoor cabling requirements are followed.

Returns

No Products will be accepted for replacement or repair without obtaining a Return Materials Authorization (RMA) number from UBIQUITI NETWORKS during the warranty period, and the Products being received at UBIQUITI NETWORKS’ facility freight prepaid in accordance with the RMA process of UBIQUITI NETWORKS. Products returned without an RMA number will not be processed and will be returned freight collect or subject to disposal. Information on the RMA process and obtaining an RMA number can be found at: www.ubnt.com/support/warranty.

Disclaimer

EXCEPT FOR ANY EXPRESS WARRANTIES PROVIDED HEREIN, UBIQUITI NETWORKS, ITS AFFILIATES, AND ITS AND THEIR THIRD PARTY DATA, SERVICE, SOFTWARE AND HARDWARE PROVIDERS HEREBY DISCLAIM AND MAKE NO OTHER REPRESENTATION OR WARRANTY OF ANY KIND, EXPRESS, IMPLIED OR STATUTORY, INCLUDING, BUT NOT LIMITED TO, REPRESENTATIONS, GUARANTEES, OR WARRANTIES OF MERCHANTABILITY, ACCURACY, QUALITY OF SERVICE OR RESULTS, AVAILABILITY, SATISFACTORY QUALITY, LACK OF VIRUSES, QUIET ENJOYMENT, FITNESS FOR A PARTICULAR PURPOSE AND NON-INFRINGEMENT AND ANY WARRANTIES ARISING FROM ANY COURSE OF DEALING, USAGE OR TRADE PRACTICE IN CONNECTION WITH SUCH PRODUCTS AND SERVICES. BUYER ACKNOWLEDGES THAT NEITHER UBIQUITI NETWORKS NOR ITS THIRD PARTY PROVIDERS CONTROL BUYER'S EQUIPMENT OR THE TRANSFER OF DATA OVER COMMUNICATIONS FACILITIES, INCLUDING THE INTERNET, AND THAT THE PRODUCTS AND SERVICES MAY BE SUBJECT TO LIMITATIONS, INTERRUPTIONS, DELAYS, CANCELLATIONS AND OTHER PROBLEMS INHERENT IN THE USE OF COMMUNICATIONS FACILITIES. UBIQUITI NETWORKS, ITS AFFILIATES AND ITS AND THEIR THIRD PARTY PROVIDERS ARE NOT RESPONSIBLE FOR ANY INTERRUPTIONS, DELAYS, CANCELLATIONS, DELIVERY FAILURES, DATA LOSS, CONTENT CORRUPTION, PACKET LOSS, OR OTHER DAMAGE RESULTING FROM ANY OF THE FOREGOING. In addition, UBIQUITI NETWORKS does not warrant that the operation of the Products will be error-free or that operation will be uninterrupted. In no event shall UBIQUITI NETWORKS be responsible for damages or claims of any nature or description relating to system performance, including coverage, buyer's selection of products (including the Products) for buyer's application and/or failure of products (including the Products) to meet government or regulatory requirements.

Limitation of Liability

EXCEPT TO THE EXTENT PROHIBITED BY LOCAL LAW, IN NO EVENT WILL UBIQUITI OR ITS SUBSIDIARIES, AFFILIATES OR SUPPLIERS BE LIABLE FOR DIRECT, SPECIAL, INCIDENTAL, CONSEQUENTIAL OR OTHER DAMAGES (INCLUDING LOST PROFIT, LOST DATA, OR DOWNTIME COSTS), ARISING OUT OF THE USE, INABILITY TO USE, OR THE RESULTS OF USE OF THE PRODUCT, WHETHER BASED IN WARRANTY, CONTRACT, TORT OR OTHER LEGAL THEORY, AND WHETHER OR NOT ADVISED OF THE POSSIBILITY OF SUCH DAMAGES.

Note

Some countries, states and provinces do not allow exclusions of implied warranties or conditions, so the above exclusion may not apply to you. You may have other rights that vary from country to country, state to state, or province to province. Some countries, states and provinces do not allow the exclusion or limitation of liability for incidental or consequential damages, so the above limitation may not apply to you. EXCEPT TO THE EXTENT ALLOWED BY LOCAL LAW, THESE WARRANTY TERMS DO NOT EXCLUDE, RESTRICT OR MODIFY, AND ARE IN ADDITION TO, THE MANDATORY STATUTORY RIGHTS APPLICABLE TO THE LICENSE OF ANY SOFTWARE (EMBEDDED IN THE PRODUCT) TO YOU. The United Nations Convention on Contracts for the International Sale of Goods shall not apply to any transactions regarding the sale of the Products.

Compliance

FCC

Changes or modifications not expressly approved by the party responsible for compliance could void the user's authority to operate the equipment.

This device complies with Part 15 of the FCC Rules. Operation is subject to the following two conditions.

1. This device may not cause harmful interference, and
2. This device must accept any interference received, including interference that may cause undesired operation.

This equipment has been tested and found to comply with the limits for a Class B digital device, pursuant to Part 15 of the FCC Rules. These limits are designed to provide reasonable protection against harmful interference in a residential installation. This equipment generates, uses and can radiate radio frequency energy and, if not installed and used in accordance with the instructions, may cause harmful interference to radio communications. However, there is no guarantee that interference will not occur in a particular installation. If this equipment does cause harmful interference to radio or television reception, which can be determined by turning the equipment off and on, the user is encouraged to try to correct the interference by one or more of the following measures:

- Reorient or relocate the receiving antenna.
- Increase the separation between the equipment and receiver.
- Connect the equipment into an outlet on a circuit different from that to which the receiver is connected.
- Consult the dealer or an experienced radio/TV technician for help.

Operations of this equipment in a residential area is likely to cause harmful interference in which case the user will be required to correct the interference at his own expense.

Industry Canada

CAN ICES-3(B)/NMB-3(B)

To reduce potential radio interference to other users, the antenna type and its gain should be so chosen that the equivalent isotropically radiated power (e.i.r.p.) is not more than that permitted for successful communication.

This device complies with Industry Canada licence-exempt RSS standard(s). Operation is subject to the following two conditions:

1. This device may not cause interference, and
2. This device must accept any interference, including interference that may cause undesired operation of the device.

CAN ICES-3(B)/NMB-3(B)

Pour réduire le risque d'interférence aux autres utilisateurs, le type d'antenne et son gain doivent être choisis de façon que la puissance isotrope rayonnée équivalente (PIRE) ne dépasse pas ce qui est nécessaire pour une communication réussie.

Cet appareil est conforme à la norme RSS Industrie Canada exempts de licence norme(s). Son fonctionnement est soumis aux deux conditions suivantes:

1. Cet appareil ne peut pas provoquer d'interférences et
2. Cet appareil doit accepter toute interférence, y compris les interférences qui peuvent causer un mauvais fonctionnement du dispositif.

RF Exposure Warning

The antennas used for this transmitter must be installed to provide a separation distance of at least 20 cm from all persons and must not be located or operating in conjunction with any other antenna or transmitter, except as listed for this product's certification.

Les antennes utilisées pour cet émetteur doit être installé pour fournir une distance de séparation d'au moins 20 cm de toutes les personnes et ne doit pas être situé ou opérant en conjonction avec une autre antenne ou un autre émetteur, sauf dans les cas énumérés à la certification de ce produit.

CE Marking

CE marking on this product represents the product is in compliance with all directives that are applicable to it.

Alert Sign (!) Follows CE Marking

Alert sign must be indicated if a restriction on use applied to the product and it must follow the CE marking.



RoHS/WEEE Compliance Statement



English

European Directive 2002/96/EC requires that the equipment bearing this symbol on the product and/or its packaging must not be disposed of with unsorted municipal waste. The symbol indicates that this product should be disposed of separately from regular household waste streams. It is your responsibility to dispose of this and other electric and electronic equipment via designated collection facilities appointed by the government or local authorities. Correct disposal and recycling will help prevent potential negative consequences to the environment and human health. For more detailed information about the disposal of your old equipment, please contact your local authorities, waste disposal service, or the shop where you purchased the product.

Deutsch

Die Europäische Richtlinie 2002/96/EC verlangt, dass technische Ausrüstung, die direkt am Gerät und/oder an der Verpackung mit diesem Symbol versehen ist, nicht zusammen mit unsortiertem Gemeindeabfall entsorgt werden darf. Das Symbol weist darauf hin, dass das Produkt von regulärem Haushaltsmüll getrennt entsorgt werden sollte. Es liegt in Ihrer Verantwortung, dieses Gerät und andere elektrische und elektronische Geräte über die dafür zuständigen und von der Regierung oder örtlichen Behörden dazu bestimmten Sammelstellen zu entsorgen. Ordnungsgemäßes Entsorgen und Recyceln trägt dazu bei, potentielle negative Folgen für Umwelt und die menschliche Gesundheit zu vermeiden. Wenn Sie weitere Informationen zur Entsorgung Ihrer Altgeräte benötigen, wenden Sie sich bitte an die örtlichen Behörden oder städtischen Entsorgungsdienste oder an den Händler, bei dem Sie das Produkt erworben haben.

Español

La Directiva 2002/96/CE de la UE exige que los equipos que lleven este símbolo en el propio aparato y/o en su embalaje no deben eliminarse junto con otros residuos urbanos no seleccionados. El símbolo indica que el producto en cuestión debe separarse de los residuos domésticos convencionales con vistas a su eliminación. Es responsabilidad suya desechar este y cualesquiera otros aparatos eléctricos y electrónicos a través de los puntos de recogida que ponen a su disposición el gobierno y las autoridades locales. Al desechar y reciclar correctamente estos aparatos estará contribuyendo a evitar posibles consecuencias negativas para el medio ambiente y la salud de las personas. Si desea obtener información más detallada sobre la eliminación segura de su aparato usado, consulte a las autoridades locales, al servicio de recogida y eliminación de residuos de su zona o pregunte en la tienda donde adquirió el producto.

Français

La directive européenne 2002/96/CE exige que l'équipement sur lequel est apposé ce symbole sur le produit et/ou son emballage ne soit pas jeté avec les autres ordures ménagères. Ce symbole indique que le produit doit être éliminé dans un circuit distinct de celui pour les déchets des ménages. Il est de votre responsabilité de jeter ce matériel ainsi que tout autre matériel électrique ou électronique par les moyens de collecte indiqués par le gouvernement et les pouvoirs publics des collectivités territoriales. L'élimination et le recyclage en bonne et due forme ont pour but de lutter contre l'impact néfaste potentiel de ce type de produits sur l'environnement et la santé publique. Pour plus d'informations sur le mode d'élimination de votre ancien équipement, veuillez prendre contact avec les pouvoirs publics locaux, le service de traitement des déchets, ou l'endroit où vous avez acheté le produit.

Italiano

La direttiva europea 2002/96/EC richiede che le apparecchiature contrassegnate con questo simbolo sul prodotto e/o sull'imballaggio non siano smaltite insieme ai rifiuti urbani non differenziati. Il simbolo indica che questo prodotto non deve essere smaltito insieme ai normali rifiuti domestici. È responsabilità del proprietario smaltire sia questi prodotti sia le altre apparecchiature elettriche ed elettroniche mediante le specifiche strutture di raccolta indicate dal governo o dagli enti pubblici locali. Il corretto smaltimento ed il riciclaggio aiuteranno a prevenire conseguenze potenzialmente negative per l'ambiente e per la salute dell'essere umano. Per ricevere informazioni più dettagliate circa lo smaltimento delle vecchie apparecchiature in Vostro possesso, Vi invitiamo a contattare gli enti pubblici di competenza, il servizio di smaltimento rifiuti o il negozio nel quale avete acquistato il prodotto.

Declaration of Conformity

Česky [Czech]	UBIQUITI NETWORKS tímto prohlašuje, a tento UBIQUITI NETWORKS device, je ve shodě se základními požadavky a dalšími požadovanými ustanoveními směrnice 1999/5/ES.
Dansk [Danish]	Undertegnede UBIQUITI NETWORKS erklærer herved, at følgende udstyr UBIQUITI NETWORKS device, overholder de væsentlige krav og øvrige relevante krav i direktiv 1999/5/EF.
Nederlands [Dutch]	Hierbij verklaart UBIQUITI NETWORKS dat het toestel UBIQUITI NETWORKS device, in overeenstemming is met de essentiële eisen en de andere relevante bepalingen van richtlijn 1999/5/EG. Bij deze verklaart UBIQUITI NETWORKS dat deze UBIQUITI NETWORKS device, voldoet aan de essentiële eisen en aan de overige relevante bepalingen van Richtlijn 1999/5/EC.
English	Hereby, UBIQUITI NETWORKS, declares that this UBIQUITI NETWORKS device, is in compliance with the essential requirements and other relevant provisions of Directive 1999/5/EC.
Eesti [Estonian]	Käesolevaga kinnitab UBIQUITI NETWORKS seadme UBIQUITI NETWORKS device, vastavust direktiivi 1999/5/EÜ põhinõuetele ja nimetatud direktiivist tulenevatele teistele asjakohastele sätetele.
Suomi [Finnish]	UBIQUITI NETWORKS vakuuttaa täten että UBIQUITI NETWORKS device, tyypinen laite on direktiivin 1999/5/EY oleellisten vaatimusten ja sitä koskevien direktiivin muiden ehtojen mukainen.
Français [French]	Par la présente UBIQUITI NETWORKS déclare que l'appareil UBIQUITI NETWORKS, device est conforme aux exigences essentielles et aux autres dispositions pertinentes de la directive 1999/5/CE.
Deutsch [German]	Hiermit erklärt UBIQUITI NETWORKS, dass sich diese UBIQUITI NETWORKS device, in Übereinstimmung mit den grundlegenden Anforderungen und den anderen relevanten Vorschriften der Richtlinie 1999/5/EG befindet. (BMW i)
Ελληνική [Greek]	ΜΕ ΤΗΝ ΠΑΡΟΥΣΑ UBIQUITI NETWORKS ΔΗΛΩΝΕΙ ΟΤΙ UBIQUITI NETWORKS device, ΣΥΜΜΟΡΦΩΝΕΤΑΙ ΠΡΟΣ ΤΙΣ ΟΥΣΙΩΔΕΙΣ ΑΠΑΙΤΗΣΕΙΣ ΚΑΙ ΤΙΣ ΛΟΙΠΕΣ ΣΧΕΤΙΚΕΣ ΔΙΑΤΑΞΕΙΣ ΤΗΣ ΟΔΗΓΙΑΣ 1995/5/ΕΚ.
Magyar [Hungarian]	Alulírott, UBIQUITI NETWORKS nyilatkozom, hogy a UBIQUITI NETWORKS device, megfelel a vonatkozó alapvető követelményeknek és az 1999/5/EC irányelv egyéb előírásainak.
Íslenska [Icelandic]	Hér með lýsir UBIQUITI NETWORKS yfir við a UBIQUITI NETWORKS device, er í samræmi við grunnkröfur og a rar kröfur, sem ger ar eru í tilskipun 1999/5/EC.

Italiano [Italian]	Con la presente UBIQUITI NETWORKS dichiara che questo UBIQUITI NETWORKS device, è conforme ai requisiti essenziali ed alle altre disposizioni pertinenti stabilite dalla direttiva 1999/5/CE.
Latviski [Latvian]	Ar o UBIQUITI NETWORKS deklar , ka UBIQUITI NETWORKS device, atbilst Direkt vas 1999/5/EK b tiskaj m pras b m un ciem ar to saist tjiem noteikumiem.
Lietuviškai [Lithuanian]	UBIQUITI NETWORKS deklaruoja, kad šis UBIQUITI NETWORKS įrenginys atitinka esminius reikalavimus ir kitas 1999/5/EB Direktyvos nuostatas.
Malti [Maltese]	Hawnhekk, UBIQUITI NETWORKS, jiddikjara li dan UBIQUITI NETWORKS device, jikkonforma mal- ti ijjiet essenzjali u ma provvedimenti o rajn relevanti li hemm fid-Dirrettiva 1999/5/EC.
Norsk [Norwegian]	UBIQUITI NETWORKS erklærer herved at utstyret UBIQUITI NETWORKS device, er i samsvar med de grunnleggende krav og øvrige relevante krav i direktiv 1999/5/EF.
Slovensky [Slovak]	UBIQUITI NETWORKS t mto vyhlasuje, e UBIQUITI NETWORKS device, sp a základné po iadavky a v etky príslu né ustanovenia Smernice 1999/5/ES.
Svenska [Swedish]	Härmed intygar UBIQUITI NETWORKS att denna UBIQUITI NETWORKS device, står i överensstämmelse med de väsentliga egenskapskrav och övriga relevanta bestämmelser som framgår av direktiv 1999/5/EG.
Español [Spanish]	Por medio de la presente UBIQUITI NETWORKS declara que el UBIQUITI NETWORKS device, cumple con los requisitos esenciales y cualesquiera otras disposiciones aplicables o exigibles de la Directiva 1999/5/CE.
Polski [Polish]	Niniejszym, firma UBIQUITI NETWORKS o wiadcza, e produkt serii UBIQUITI NETWORKS device, spelnia zasadnicze wymagania i inne istotne postanowienia Dyrektywy 1999/5/EC.
Português [Portuguese]	UBIQUITI NETWORKS declara que este UBIQUITI NETWORKS device, está conforme com os requisitos essenciais e outras disposições da Directiva 1999/5/CE.
Română [Romanian]	Prin prezenta, UBIQUITI NETWORKS declară că acest dispozitiv UBIQUITI NETWORKS este în conformitate cu cerințele esențiale și alte prevederi relevante ale Directivei 1999/5/CE.

Online Resources

Support support.ubnt.com

Community community.ubnt.com

Downloads downloads.ubnt.com

©2013-2016 Ubiquiti Networks, Inc. All rights reserved. Ubiquiti, Ubiquiti Networks, the Ubiquiti U logo, the Ubiquiti beam logo, and UniFi are trademarks or registered trademarks of Ubiquiti Networks, Inc. in the United States and in other countries. All other trademarks are the property of their respective owners.

JL030116