

# MATRICE 30 SERIES

M30 / M30 T

## User Manual

v1.2 2022.08

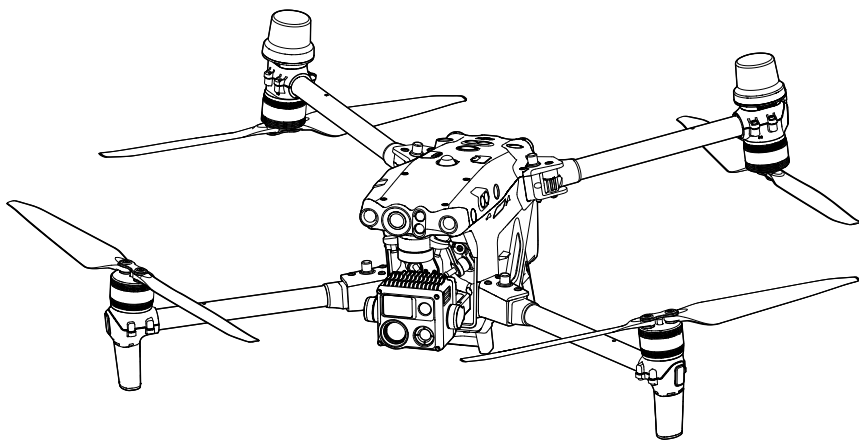



User Manuals, instructions and other material about product functions and specifics are DJI confidential Materials. Users are licensed to use these materials only for purposes of operating and using DJI Products. Unless otherwise authorized in this Terms, you are not eligible to use or allow others to use the Materials or any part of the Materials by reproducing, transferring or selling the Materials. Users should only refer to this document and the content thereof as instructions to operate DJI UAV. The document should not be used for other purposes.

### Searching for Keywords

Search for keywords such as “battery” and “install” to find a topic. If you are using Adobe Acrobat Reader to read this document, press Ctrl+F on Windows or Command+F on Mac to begin a search.

### Navigating to a Topic

View a complete list of topics in the table of contents. Click on a topic to navigate to that section.

### Printing this Document

This document supports high resolution printing.

## Revision Log

Version	Date	Revisions
v1.2	2022.7	Updated DJI AirSense and rear indicator descriptions.

# Using This Manual

## Legends

 Important

 Hints and Tips

 Reference

## Read Before Use

DJI™ provides users with tutorial videos and the following documents.

1. In the Box
2. Disclaimer and Safety Guidelines
3. Intelligent Flight Battery Safety Guidelines
4. Quick Start Guide
5. BS30 Intelligent Battery Station User Guide
6. User Manual

It is recommended to watch all the tutorial videos and read the Disclaimer and Safety Guidelines before using for the first time. Prepare for your first flight by reviewing the quick start guide and refer to this manual for more information.

## Downloading DJI Assistant 2 (Enterprise Series)

Download and install DJI ASSISTANT™ 2 (Enterprise Series) using the link below:  
<https://www.dji.com/matrice-30/downloads>

## Tutorial Videos

Go to the address below or scan the QR code to watch the DJI Matrice 30 tutorial videos, which demonstrate how to use the Matrice 30 safely.



<https://www.dji.com/matrice-30/video>

---

 The operating temperature of this product is -20° to 50° C. It does not meet the standard operating temperature for military grade application (-55° to 125° C), which is required to endure greater environmental variability. Operate the product appropriately and only for applications that it meets the operating temperature range requirements of that grade.

---

# Contents

<b>Using This Manual</b>	<b>3</b>
Legends	3
Read Before Use	3
Downloading DJI Assistant 2 (Enterprise Series)	3
Tutorial Videos	3
<b>Product Profile</b>	<b>9</b>
Introduction	9
Feature Highlights	10
<b>Flight Safety</b>	<b>12</b>
Flight Environment Requirements	12
Wireless Communications Requirements	12
Vision System and Infrared Sensing System	13
Introduction	13
Detection Range	14
Calibrating the Vision System	15
Vision Positioning	15
Obstacle Sensing	16
Infrared Sensing System	16
Warnings	16
Return to Home (RTH)	18
Smart RTH	18
Low Battery RTH	18
Failsafe RTH	20
RTH Procedure	20
RTH Safety Precautions	21
Obstacle Sensing during RTH	21
Landing Protection	22
Flight Restrictions and Unlocking	23
GEO (Geospatial Environment Online) System	23
GEO Zones	23
Flight Restrictions in GEO Zones	23
Unlocking GEO Zones	26
Maximum Altitude & Distance Restrictions	27
Calibrating the Compass	28
Calibration Procedure	28
Three-Propeller Emergency Landing	29
DJI AirSense	30
Pre-Flight Checklist	31

<b>Aircraft</b>	<b>33</b>
Activating the Aircraft	33
Aircraft Overview	33
FPV Camera	35
Propellers	35
Using the Propellers	35
Storing the Propellers	36
Replacing the Propeller Blades	36
Aircraft Indicators	37
Aircraft Beacons	38
Aircraft Auxiliary Lights	38
Gimbal Cameras	39
Operation	39
Using the microSD Card	40
Gimbal	41
Gimbal Lock	42
Gimbal Operation	42
Gimbal Mode	43
Aircraft RTK	45
RTK Module Introduction	45
Enabling/Disabling RTK	45
D-RTK 2 High Precision GNSS Mobile Station	45
Custom Network RTK	45
IP Rating	46
PSDK Port	46
<b>Remote Controller</b>	<b>48</b>
Starting and Activating the Remote Controller	48
Powering On/Off	48
Activating the Remote Controller	48
Remote Controller Overview	49
Mounting the WB37 Intelligent Battery	52
Mounting the Dongle	52
Mounting the Strap and Bracket Kit	53
Adjusting the Antennas	54
IP Rating	54
User Interface	56
Home Screen	56
Screen Gestures	57
Shortcut Settings	57
Video Transmission	59
Remote Controller LEDs and Alert	59

Remote Controller LEDs	59
Remote Controller Alert	59
<b>Charging the Remote Controller and Checking the Battery Level</b>	<b>60</b>
Charging the Remote Controller	60
Checking the Battery Level	61
<b>Linking the Remote Controller and Control Stick Modes</b>	<b>62</b>
Linking the Remote Controller	62
Control Stick Mode	63
<b>Buttons Overview</b>	<b>65</b>
RTH Button	65
L1/L2/L3/R1/R2/R3 Buttons	65
Button Customization and Combinations	65
<b>Flight Mode Switch (N/S/F)</b>	<b>67</b>
<b>Calibrating the Compass</b>	<b>69</b>
<b>HDMI Settings</b>	<b>69</b>
<b>Advanced Dual Operator Mode</b>	<b>69</b>
<b>Intelligent Battery Station</b>	<b>72</b>
Battery Station Overview	72
Warnings	73
Using the Battery Station	73
Battery Station LEDs and Alert	75
Battery Station LEDs Description	75
Buzzer Sound Description	75
<b>Intelligent Flight Battery</b>	<b>77</b>
Introduction	77
Battery Features	77
Using Paired Batteries	78
Powering On/Off	78
Checking Battery Level	78
Hot Battery Replacement	79
Warming the Battery	79
Battery Storage	80
Battery Maintenance	80
Capacity Calibration	80
Battery Maintenance	80
<b>DJI Pilot 2 App</b>	<b>83</b>
Homepage	83
Preflight Check View	87
FPV Camera View	88

Using FPV Camera View	88
Primary Flight Display (PFD)	89
Navigation Display	90
Top Bar	92
AR Projection	94
<b>Gimbal Camera View</b>	<b>95</b>
Using Gimbal Camera View	95
Wide Camera View	98
Thermal Camera View	98
Laser Rangefinder (RNG)	99
Smart Track	100
<b>Map View</b>	<b>103</b>
<b>Annotation Management and Synchronization</b>	<b>104</b>
PinPoint	104
Line and Area Annotation Management	107
Annotation Sharing	108
<b>Mission Flight</b>	<b>109</b>
Mission Flight Introduction	109
Mission Flight - Setting Waypoints	110
Mission Flight - Live Mission Recording	111
In-Flight Editing	112
<b>Health Management System (HMS)</b>	<b>113</b>
Intelligent Battery Station Status and Log Management	114
<b>DJI FlightHub 2</b>	<b>114</b>
<b>Firmware Update</b>	<b>116</b>
<b>Using DJI Pilot 2</b>	<b>116</b>
Aircraft and Remote Controller	116
Battery Station and TB30 Batteries	116
Offline Update	117
<b>Using DJI Assistant 2 (Enterprise Series)</b>	<b>117</b>
Aircraft and Remote Controller	117
<b>Appendix</b>	<b>119</b>
Introduction to the Carrying Case	119
Specifications	120

# Product Profile

---

This chapter introduces the major features of the product.



# Product Profile

## Introduction

The DJI™ MATRICE™ 30 Series (M30/M30T) is a powerful industrial drone platform with a multi-redundancy flight controller system, 6 directional sensing and positioning system<sup>[1]</sup>, precise three-axis gimbal, high-performance multi-camera load, and a new FPV camera with night vision. The DJI Pilot 2 app can be used to observe the real-time view from the cameras and take photos and videos. The aircraft boasts a flight time of up to 41 minutes<sup>[2]</sup> thanks to the advanced power management system along with the dual batteries that ensure power supply and enhance flight safety.

Its airframe design gives it an IP55 rating, in accordance with the global IEC 60529 standard, which effectively guarantees flight in all weather. The mechanical design, along with mounted folding arms and propellers, makes it easy to transport and store. The arms can be locked directly after unfolding, which can reduce the time needed to prepare for flight. The aircraft is also equipped with a PSDK port so users can broaden its applications.

The built-in DJI AirSense system detects nearby aircraft in the surrounding airspace, providing alerts in the DJI Pilot 2 app to ensure safety. Safety during takeoff, flight, and landing are improved with the safety beacons that help to identify the aircraft during flight and the auxiliary lights allow the vision positioning system to achieve an even greater performance at night or when there is low light. The built-in RTK provides more accurate navigational data for positioning to meet accurate operation requirements and ensure safety.

The DJI RC Plus remote controller features O3 Enterprise, the latest version of DJI's signature OCUSYNC™ video transmission technology, and can transmit a live HD view from the camera of an aircraft to display on the touchscreen. The remote controller comes with a wide range of functional buttons as well as customizable buttons, which can easily control the aircraft and operate the camera.

The remote controller has a protection rating of IP54 (IEC 60529). The built-in 7.02 inch high brightness 1200 cd/m<sup>2</sup> screen boasts a resolution of 1920x1200 pixels. The Android operating system comes with a variety of functions such as GNSS, Wi-Fi, and Bluetooth. The remote controller supports 65W fast charging and has a maximum operating time of 3 hours 18 minutes<sup>[3]</sup> with the internal battery and up to 6 hours when used with an external WB37 intelligent battery.<sup>[4]</sup>

- [1] The vision system and infrared sensing system are affected by the surrounding environment. Read the Disclaimer and Safety Guidelines for more information.
- [2] The maximum flight time was tested in a lab environment and is for reference only.
- [3] The maximum operating time of the remote controller was tested in a lab environment at room temperature. It is for reference only. Actual operating time may differ by scenario.
- [4] The WB37 Intelligent Battery needs to be purchased separately. Read the WB37 Intelligent Battery Safety Guidelines before use.



- Compliance Version: The remote controller is compliant with local regulations.
- Control Stick Mode: There are three modes (Mode 1, Mode 2, and Mode 3) available to choose from in the DJI Pilot 2 App, with the default being Mode 2. It is recommended for beginners to use Mode 2.



To avoid interference, DO NOT operate more than three aircraft simultaneously in the same area (about the size of a football field).

---

## Feature Highlights

**PinPoints:** A PinPoint can be added for a target to select a point of interest in the gimbal camera view. Besides generating its longitude and latitude, a PinPoint can be used to search and mark points of interest, such as emergency rescues, security operations, and surveillance.

**Live Annotations:** Users can add PinPoints, lines, and areas in the map view of the remote controller and DJI FlightHub 2. Share annotation data to the companion controller in the Dual Control mode and other devices logged in to DJI FlightHub 2. Data is shared in real time which facilitates operations across the air and ground.

**AR Projection:** DJI Pilot 2 supports the projection of Home Point, PinPoint, and Waypoint locations in the FPV camera view or the gimbal camera view, providing users with clear flight targets and better situation awareness.

**Cloud Mapping:** When the remote controller is logged in to DJI FlightHub 2, the aircraft can perform a cloud mapping task, which enables viewing of and generates a map on DJI FlightHub 2 simultaneously.\*

\* For more details, refer to the DJI FlightHub 2 User Guide which is available to download from the official DJI website <https://www.dji.com/flighthub-2/downloads>.

# Flight Safety

---

This chapter provides information about flight environment requirements, wireless communication requirements, and important flight safety features of the aircraft.

# Flight Safety

Make sure to have training and practice before operating any actual flight. Practice with the simulator in DJI Assistant 2 or fly under the guidance of experienced professionals. Pick a suitable area to fly in according to the following flight requirements and restrictions. Fly the aircraft below 120 m (400 ft). Any flight altitude higher than that may violate local laws and regulations. Make sure you understand and comply with the local laws and regulations before flying. Read the Disclaimer and Safety Guidelines carefully to understand all safety precautions before flying.

## Flight Environment Requirements

1. DO NOT fly the aircraft in severe weather conditions. These include strong winds exceeding speeds of 15 m/s, snow, rain, fog, hail, lightning, tornadoes, hurricanes, and other weather with low visibility.
2. Place the aircraft on open and unobstructed flat ground to take off. Make sure the aircraft is at a safe distance from any surrounding obstacles, buildings, crowds, or trees. Fly the aircraft within the visual line of sight (VLOS) to ensure flight safety.
3. If light conditions surrounding the aircraft are poor, the navigation information on DJI Pilot 2 will show that the vision system or infrared sensing system is not functioning. This means the vision system and the infrared sensing system may not be working properly and the aircraft is unable to sense obstacles. Observe the surrounding environment at all times through the live FPV camera view and maintain control of the aircraft to ensure flight safety.
4. Make sure the beacons and the auxiliary lights are enabled at night for flight safety.
5. DO NOT take off from a moving vehicle.
6. To avoid affecting the motor service life, DO NOT take off or land the aircraft on sandy or dusty areas.

## Wireless Communications Requirements

1. Make sure that the antennas on the front arms and the bottom of the aircraft body are not damaged or loose.
2. Fly in wide open areas. Tall buildings, steel structures, mountains, rocks, or tall trees may affect the accuracy of the GNSS and block the video transmission signal.
3. To avoid interference with the remote controller from other wireless equipment, make sure to power off nearby Wi-Fi and Bluetooth devices when controlling the aircraft remotely.
4. Be extremely alert when flying near areas with magnetic or radio interference. Pay close attention to the video transmission quality and signal strength on DJI Pilot 2. Sources of electromagnetic interference include but are not limited to: high voltage lines, large scale power transmission stations or mobile base stations, and broadcasting towers. The aircraft may behave abnormally or lose control when flying in areas with too much interference. Return to the Home Point and land the aircraft if prompted to do so in DJI Pilot 2.

## Vision System and Infrared Sensing System

### Introduction

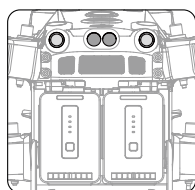
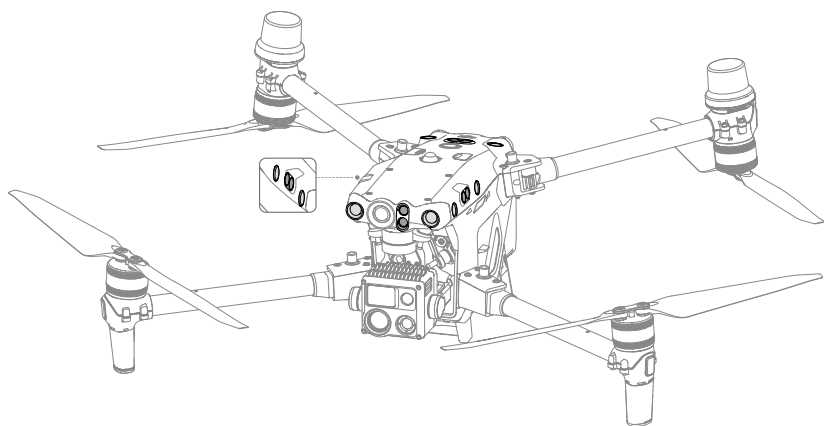

Rear View

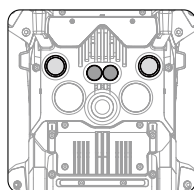

Bottom View

The main components of the vision system (cameras with stereo vision sensors) are located on the front, rear, left, right, top and bottom of the aircraft. The infrared sensing system has two infrared sensors on each side of the aircraft (front, rear, left, right, top, and bottom).

The vision system constantly scans for obstacles and uses image data to calculate the aircraft position, and the infrared sensing system uses infrared sensors to detect obstacles and determine the flight altitude. Both systems work together to position the aircraft and sense obstacles during flight.

---

 To ensure a safe and steady flight, DO NOT block the vision and infrared sensors.

---

## Detection Range

### Detection Range of the Vision System

The detection range of the vision system is depicted below. Note that aircraft cannot sense obstacles that are out of the detection range. Fly with caution.

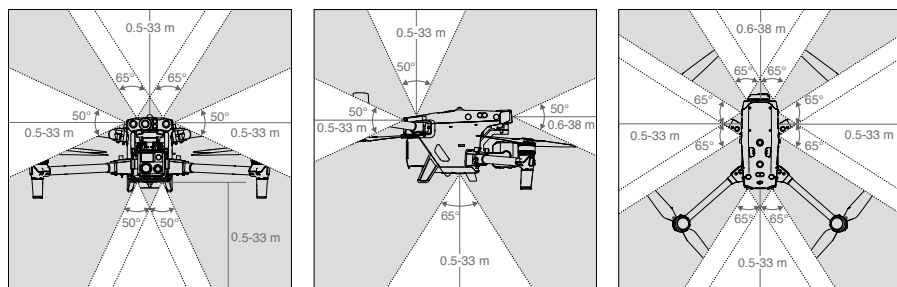

⚠ The gray area is the blind spot of the vision system, where the aircraft cannot detect objects. Fly with caution.

☀ Users can set the braking and warning distances in DJI Pilot 2. The aircraft brakes automatically when approaching the braking distance. When the aircraft is in the warning distance, DJI Pilot 2 will display an orange alert in obstacle information. When the aircraft is close to the braking distance, a red alert will appear in obstacle information.

### Detection Range of the Infrared Sensing System

The detection range of the infrared sensors is 0.1 to 10 m (0.33 to 33 ft). Be aware of the blind spot (marked grey) of the infrared sensing system. The Aircraft cannot detect and avoid obstacles that are out of the detection range.

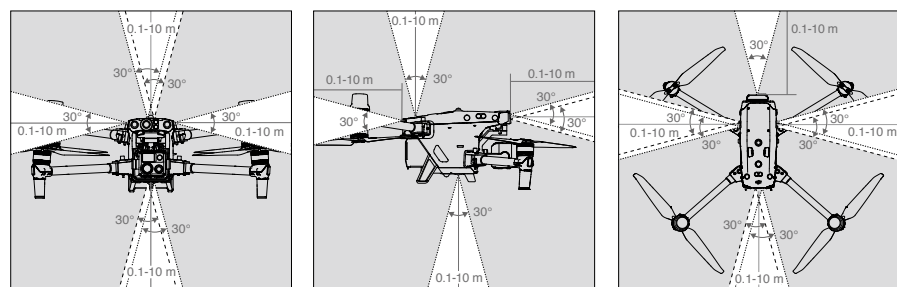

## Calibrating the Vision System

The vision systems installed on the aircraft is factory calibrated. If the aircraft experiences a collision or a significant change in the operating temperature, calibration may be required. DJI Pilot 2 will display a prompt when calibration is required. Follow these steps to calibrate the vision system when prompted:

1. Power on the aircraft.
2. Connect the assistant port of the aircraft to the computer.
3. Launch DJI Assistant 2 (Enterprise Series) and log in using a DJI account.
4. Select the M30 Series, then click the calibration button.
5. Position the aircraft with the vision system facing the dotted pattern displayed on the computer screen, and follow the on-screen instructions to calibrate the vision sensors on each side.

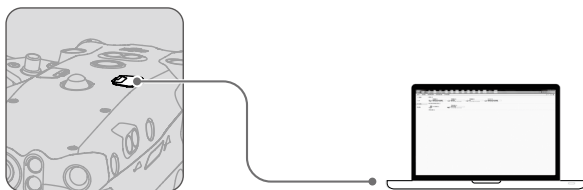



---

**⚠** DO NOT power off the aircraft or unplug the cable after calibration. Wait for the data calculation to complete.

---

## Vision Positioning

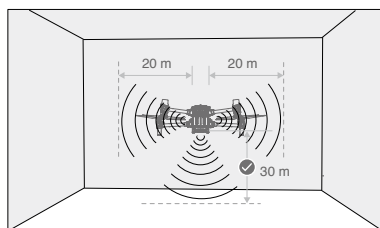
The vision system enables the aircraft to fly indoors or in environments where GNSS is not available. When the GNSS signal is available, the vision system provides information that improves aircraft positioning accuracy. The vision system works well when flying within 30 m (98.43 ft) above the ground and 20 m (65.62 ft) horizontally from any object to its side, provided that the object's surface has clear patterns or texture and the lighting is adequate. When the vision system is not working, the flight mode will switch to Attitude Mode.





---

**⚠** If the vision system is disabled or blocked by other objects, the aircraft will not be able to hover indoors at a low altitude, and Landing Protection will not work. Control the landing speed as high-speed landing may damage the aircraft.

---

### Obstacle Sensing

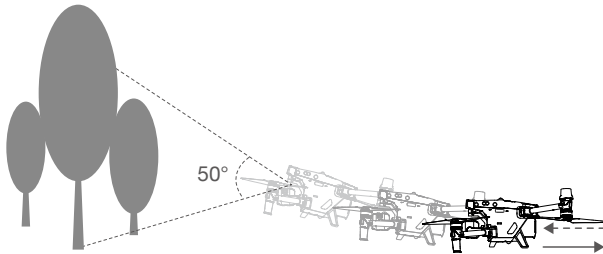
Obstacle sensing works best when the lighting is adequate and the obstacle is clearly textured. It does not work well with obstacles that are less dense such as twigs on a tree. The aircraft must fly at a speed below 17 m/s with a maximum tilt angle of 25° to ensure a sufficient braking distance. Aircraft cannot sense obstacles that are out of the detection range.



### Infrared Sensing System

The infrared sensing system can only be used to sense large or highly reflective obstacles and rough surfaces. Aircraft cannot sense obstacles that are out of the detection range. The downward infrared sensing system is used for positioning and assisting with altitude calculations during takeoff and landing, while the infrared sensing system on the other five sides is for obstacle sensing.

### Warnings

The measurement accuracy of the vision system is easily affected by the light intensity and the surface texture of the object. The infrared sensing system can only be used to sense large or highly reflective obstacles and rough surfaces. The vision system may NOT function properly in the following situations:

- a. Flying over monochrome surfaces (e.g., pure black, white, red, or green) or those without clear texture.
- b. Flying over surfaces with strong reflected light or images.
- c. Flying over water, ice, or transparent surfaces.
- d. Flying over moving surfaces or objects (e.g., moving crowds, or swaying reeds, shrubs, or grass).
- e. Flying in an area where lighting changes frequently or drastically or with direct exposure to strong light.
- f. Flying over extremely dark (< 15 lux) or extremely bright (> 10,000 lux) surfaces.
- g. Flying at high speeds below 2 m above the ground (e.g., faster than 14 m/s at a 2m height or 5 m/s at a 1m height).
- h. Small obstacles (e.g., iron wires, cables, tree branches, or leaves).
- i. The lens is dirty (e.g., from raindrops or fingerprints).
- j. In low-visibility environments (e.g., heavy fog or snow).



The infrared sensing systems may NOT detect the distance accurately in the following situations:

- a. Flying over surfaces that can absorb sound waves (e.g., asphalt road surfaces).
- b. A large area of strong reflectors situated at a distance of more than 15 m (e.g., multiple traffic signs placed side by side).
- c. Small obstacles (e.g., iron wires, cables, tree branches, or leaves).
- d. Mirrors or transparent objects (e.g., water or glass).
- e. In low-visibility environments (e.g., heavy fog or snow).





- Keep the vision sensors clean at all times. Any dirt or stain may affect their function.
- The vision system relies on surface patterns or texture to process image data and obtain position information. Make sure the surrounding environment has sufficient lighting and clearly textured ground.
- The vision system cannot function properly in dark environments and over surfaces without clear patterns or texture such as water and ice.



- The aircraft cannot avoid moving obstacles such as people, animals, or vehicles.
-

## Return to Home (RTH)

If the signal between the remote controller and the aircraft is lost and there is a strong GNSS signal, Return to Home (RTH) returns the aircraft back to the last recorded Home Point and lands. There are three RTH modes: Smart RTH, Low Battery RTH, and Failsafe RTH.

☰	GNSS	Description
Home Point		The Home Point is recorded when the GNSS icon  is white during takeoff. The DJI Pilot 2 will give voice prompt when the Home Point is set.

- ⚠ During RTH, the aircraft can sense and avoid obstacles when the forward vision system is enabled and lighting is sufficient. After avoiding an obstacle, the aircraft will fly to the Home Point at the current altitude and land automatically.
- The aircraft cannot rotate or fly left or right during RTH.

### Smart RTH

Press and hold the RTH button on the remote controller to initiate Smart RTH. Use the remote controller to control the aircraft's flight speed and altitude to avoid collision during the process. Press the RTH button to exit Smart RTH and regain full control of the aircraft.



### Low Battery RTH

To avoid unnecessary danger caused by insufficient power, the aircraft will automatically calculate if it has enough power to fly to the Home Point from its current location. A warning prompt will appear in DJI Pilot 2 when the battery level is low and the aircraft can only support Low Battery RTH. The aircraft will automatically fly to the Home Point if no action is taken after a 10-second countdown. Cancel RTH by pressing the RTH button or the Pause button on the remote controller.

A low battery level warning will be prompted only once during a flight. If RTH is canceled following the warning, the Intelligent Flight Battery may not have enough power for the aircraft to land safely, which may lead to the aircraft crashing or being lost.

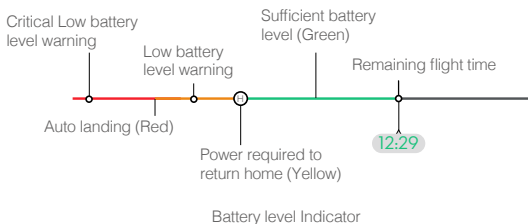
The aircraft will land automatically if the current battery level can only support the aircraft to descend from its current altitude. Auto landing cannot be canceled. During the forced landing process, users can control the throttle, pitch and roll sticks to fly the aircraft to the safe landing position, but the continuous descent action of the aircraft cannot be canceled.



Battery Level Warning	Description	Flight Instructions
Low Battery RTH	The remaining battery level is only enough for the aircraft to fly to the Home Point safely.	If RTH is selected, the aircraft will fly to the Home Point automatically and landing protection will be enabled. Regain control of the aircraft and land it manually during RTH. <b>⚠ The warning will not appear again after choosing not to use RTH. Decide carefully and ensure flight safety.</b>
Auto Landing	The remaining battery level is only enough for the aircraft to descend from its current altitude.	The aircraft will land automatically and the landing protection will be enabled.
Estimated Remaining Flight Time	Estimated remaining flight time of the aircraft is based on its current battery level.	N/A
Low Battery Level Warning	Tap ●●● and tap  in camera view to set the low battery level threshold value.*	Long beeps will sound from the remote controller. The user can still control the aircraft.
Critical Low Battery Level Warning	Tap ●●● and tap  in camera view to set the critical low battery level threshold value. *	Short beeps will sound from the remote controller. The user can still control the aircraft. It is unsafe to continue flying the aircraft. Land immediately.

\* The threshold value is different from that of Low Battery RTH or auto landing.

- 
- ⚠**
- During auto landing, the user can push the throttle stick to make the aircraft hover at its current altitude or ascend, moving the aircraft to a more suitable landing location.
  - The colored zones and the estimated remaining flight time on the battery level indicator are automatically adjusted according to the aircraft's current location and status.
-

### Failsafe RTH

Failsafe RTH is automatically enabled when the remote controller signal is lost. RTH is the default failsafe action in the app. Failsafe RTH includes two stages: Original Route RTH and Smart RTH. When Failsafe RTH is enabled, the aircraft will fly to the Home Point on its original flight route for a maximum distance of 50 m (164 ft), during which it will try to reconnect to the remote controller. If the aircraft cannot reconnect to the remote controller within 50 m (164 ft) or detects obstacles during RTH, the aircraft will exit Original Route RTH and enter the Smart RTH stage. The aircraft will remain in RTH mode even after the remote controller signal is restored. The user can use the remote controller to control the aircraft's flight speed and altitude, and exit RTH by pressing the RTH button on the remote controller.

### RTH Procedure

1. The Home Point is recorded automatically.
2. RTH is triggered, i.e. Smart RTH, Low Battery RTH, or Failsafe RTH.
3. The Home Point is confirmed and the aircraft adjusts its orientation.
4. Return to Home (RTH):
  - a. The aircraft will land immediately if it is less than 5 m (16.4 ft) from the Home Point.
  - b. If the aircraft is farther than 5 m (16.4 ft) from the Home Point and above the preset RTH altitude, the aircraft will fly directly to the Home Point at the current altitude. If it is below the preset RTH altitude, the aircraft will ascend to the preset RTH altitude before flying to the Home Point.
5. The aircraft will automatically fly to the Home Point. Landing Protection\* will be triggered to allow the aircraft to land immediately or hover. Refer to the Landing Protection section for details.

\* Make sure that the downward vision system is enabled in DJI Pilot 2.

 • The user can also exit RTH by pushing the control stick in the opposite direction of the flight (e.g., pushing the throttle stick down when the aircraft is ascending).

The process is illustrated below using Smart RTH as an example.

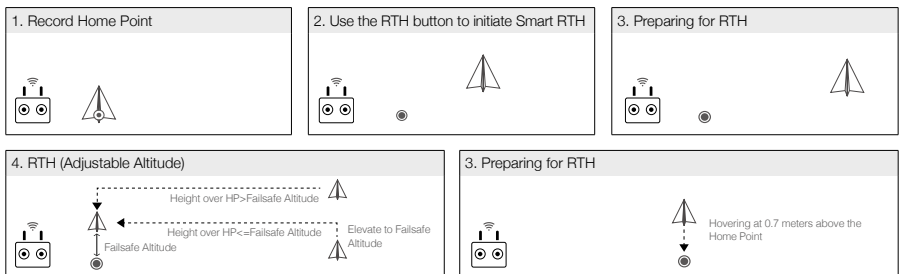

## RTH Safety Precautions



The aircraft cannot avoid obstacles during RTH when the forward vision system is disabled. However, the user can still control the speed and the altitude of the aircraft with the remote controller if a signal is available. Therefore, it is important to set a suitable RTH altitude before each flight. Launch DJI Pilot 2, enter the Preflight Check view or tap **•••** and tap  in camera view to set the RTH altitude.



The RTH feature will be disabled when the GNSS signal icon is red or yellow, or the GNSS is unavailable.

## Obstacle Sensing during RTH

The aircraft can sense and avoid obstacles during RTH if the lighting is sufficient for obstacle sensing. The obstacle sensing procedure is as follows:

1. The aircraft decelerates when an obstacle is sensed at approximately 20 m (65.62 ft) ahead.
2. The aircraft stops and hovers, then ascends to avoid the obstacle. Eventually, the aircraft stops ascending when it is at least 5 m (16.4 ft) above the detected obstacle.
3. The aircraft continues flying to the Home Point at its current altitude.

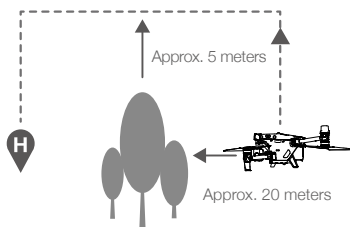

- To ensure the aircraft flies forward to the Home Point, the user is unable to rotate the aircraft during RTH.
- During RTH, obstacles on either side of the aircraft cannot be detected or avoided.

## Landing Protection

1. Landing protection is activated during auto landing and is executed as follows:
2. The aircraft will land directly if landing protection determines the ground is suitable for landing.
3. If the ground is determined unsuitable for landing, the aircraft will hover. A prompt will appear in DJI Pilot 2 pending the next action by the user. The aircraft will start descending only when the battery level drops to 0%. During this process, the user can still control the orientation of the aircraft.
4. If landing protection is not functioning, DJI Pilot 2 will display a landing prompt when the aircraft descends below 0.7 m (2.3 ft) above the ground. After making sure the environment is suitable for landing, tap to confirm or push the throttle stick all the way down and hold for one second, and the aircraft will land.



Landing protection will not work in the following circumstances:

- a. When the downward vision system is disabled
  - b. When the user is operating the pitch/roll/throttle stick (landing protection will be re-activated when the control stick is not in use).
  - c. When the positioning system is not functioning properly (e.g., position drift errors).
  - d. When the vision system needs calibrating. When the lighting is too dim for the vision system to operate.
  - e. If an obstacle is within 1 m (3.28 ft) of the aircraft, no valid observation data is obtained, and the ground conditions cannot be detected, the aircraft will descend to 0.7 m (2.3 ft) above the ground and hover pending confirmation by the user to land.
-

## Flight Restrictions and Unlocking

### GEO (Geospatial Environment Online) System

DJI's Geospatial Environment Online (GEO) system is a global information system that provides real-time information on flight safety and restriction updates and prevents UAVs from flying in restricted airspace. Under exceptional circumstances, restricted areas can be unlocked to allow flights in. Prior to that, the user must submit an unlocking request based on the current restriction level in the intended flight area. The GEO system may not fully comply with local laws and regulations. Users shall be responsible for their own flight safety and must consult with the local authorities on the relevant legal and regulatory requirements before requesting to unlock a flight in a restricted area.

### GEO Zones

DJI's GEO system designates safe flight locations, provides risk levels and safety notices for individual flights, and offers information on restricted airspace. All restricted flight areas are referred to as GEO Zones, which are further divided into Restricted Zones, Authorization Zones, Warning Zones, Enhanced Warning Zones, and Altitude Zones. Users can view such information in real time in DJI Pilot 2. GEO Zones are specific flight areas, including but not limited to airports, large event venues, locations where public emergencies have occurred (such as forest fires), nuclear power plants, prisons, government properties, and military facilities. By default, the GEO system limits takeoffs and flights in zones that may cause safety or security concerns. A GEO Zone map that contains comprehensive information on GEO Zones around the globe is available on the official DJI website: <https://www.dji.com/flysafe/geo-map>.

### Flight Restrictions in GEO Zones

The following section describes in detail the flight restrictions for the abovementioned GEO Zones.

GEO Zone	Flight Restriction	Scenario
Restricted Zones (Red)	UAVs are prohibited from flying in Restricted Zones. If you have obtained permission to fly in a Restricted Zone, please visit <a href="https://www.dji.com/flysafe">https://www.dji.com/flysafe</a> or contact <a href="mailto:flysafe@dji.com">flysafe@dji.com</a> to unlock the zone.	Takeoff: The aircraft motors cannot be started in Restricted Zones.
		In Flight: When the aircraft flies inside a Restricted Zone, a 100-second countdown will commence in DJI Pilot 2. When the countdown is finished, the aircraft will land immediately in semi-automatic descent mode and turn off its motors after landing.
		In Flight: When the aircraft approaches the boundary of a Restricted Zone, the aircraft will automatically decelerate and hover.

<p><b>Authorization Zones (Blue)</b></p>	<p>The aircraft will not be able to take off in an Authorization Zone unless it obtains a permission to fly in the area.</p>	<p>Takeoff: The aircraft motors cannot be started in Authorization Zones. To fly in an Authorization Zone, the user is required to submit an unlocking request registered with a DJI-verified phone number.</p> <p>In Flight: When the aircraft flies inside an Authorization Zone, a 100-second countdown will commence in DJI Pilot 2. When the countdown is finished, the aircraft will land immediately in semi-automatic descent mode and turn off its motors after landing.</p>
<p><b>Warning Zones (Yellow)</b></p>	<p>A warning will be displayed when the aircraft flies inside a Warning Zone.</p>	<p>The aircraft can fly in the zone but the user is required to understand the warning.</p>
<p><b>Enhanced Warning Zones (Orange)</b></p>	<p>When the aircraft flies in an Enhanced Warning Zone, a warning will be displayed prompting the user to confirm the flight path.</p>	<p>The aircraft can continue to fly once the warning is confirmed.</p>
<p><b>Altitude Zones (Gray)</b></p>	<p>The aircraft altitude is limited when flying inside an Altitude Zone.</p>	<p>When the GNSS signal is strong, the aircraft cannot fly above the altitude limit.</p> <p>In Flight: When the GNSS signal changes from weak to strong, a 100-second countdown will commence in DJI Pilot 2 if the aircraft exceeds the altitude limit. When the countdown is finished, the aircraft will descend below the altitude limit and hover.</p> <p>When the aircraft approaches the boundary of an Altitude Zone and the GNSS signal is strong, the aircraft will decelerate automatically and hover if the aircraft is above the altitude limit.</p>

 **Semi-Automatic Descent:** All stick commands except the throttle stick command and the RTH button are available during descent and landing. The aircraft motors will turn off automatically after landing. It is recommended to fly the aircraft to a safe location before the semi-automatic descent.

### Buffer Zone

**Buffer Zones for Restricted Zones/Authorization Zones:** To prevent the aircraft from accidentally flying into a Restricted or Authorization Zone, the GEO system creates a buffer zone of about 20 meters wide outside each Restricted and Authorization Zone. As shown in the illustration below, the aircraft can only take off and land in place or fly toward an opposite direction of the Restricted or Authorization Zone when inside the buffer zone, and cannot fly toward the Restricted or Authorization Zone unless an unlocking request has been approved. **The aircraft cannot fly back into the buffer zone after leaving the buffer zone.**

**Buffer Zones for Altitude Zones:** A buffer zone of about 20 meters wide is established outside each Altitude Zone. As shown in the illustration below, when approaching the buffer zone of an Altitude Zone in a horizontal direction, the aircraft will gradually reduce its flight speed and hover outside the buffer



zone. When approaching the buffer zone from underneath in a vertical direction, the aircraft can ascend and descend in altitude or fly in an opposite direction of the Altitude Zone, but cannot fly toward the Altitude Zone. The aircraft cannot fly back into the buffer zone in a horizontal direction after leaving the buffer zone.

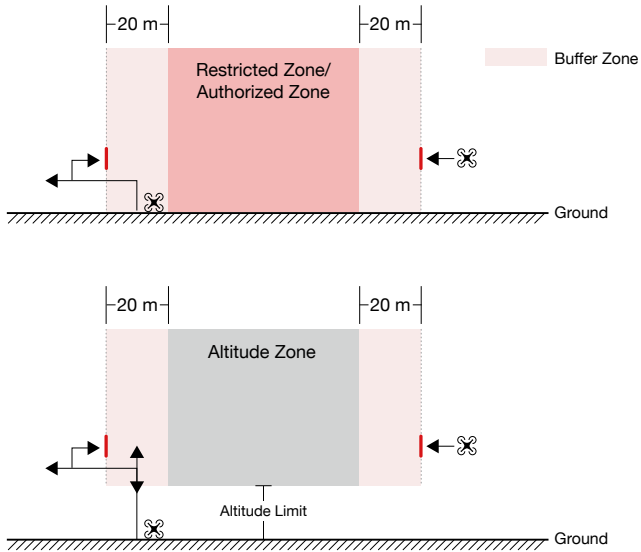

## Unlocking GEO Zones

To satisfy the needs of different users, DJI provides two unlocking modes: Self-Unlocking and Custom Unlocking. Users may request for either on the DJI Fly Safe website or via a mobile device.

**Self-Unlocking** is intended for unlocking Authorization Zones. To complete Self-Unlocking, the user is required to submit an unlocking request via the DJI Fly Safe website at <https://www.dji.com/flysafe>. Once the unlocking request is approved, the user may synchronize the unlocking license through the DJI Pilot 2 app (Live Self-Unlocking) to unlock the zone; alternatively, the user may launch or fly the aircraft directly into the approved Authorization Zone and follow the prompts in DJI Pilot 2 to unlock the zone (Scheduled Self-Unlocking). For Live Self-Unlocking, the user can designate an unlocked period during which multiple flights can be operated. Scheduled Self-Unlocking is only valid for one flight. If the aircraft is restarted, the user will need to unlock the zone again.

**Custom Unlocking** is tailored for users with special requirements. It designates user-defined custom flight areas and provides flight permission documents specific to the needs of different users. This unlocking option is available in all countries and regions and can be requested for via the DJI Fly Safe website at <https://www.dji.com/flysafe>.

**Unlocking on Mobile Device:** Run the DJI Pilot 2 app and tap GEO Zone Map on the home screen. View the list of the unlocking licenses and tap ⓘ to view details of the unlocking license. A link to the unlocking license and a QR code will be displayed. Use your mobile device to scan the QR code and apply to unlock directly from the mobile device.

For more information about unlocking, please visit <https://www.dji.com/flysafe> or contact [flysafe@dji.com](mailto:flysafe@dji.com).

## Maximum Altitude & Distance Restrictions

Maximum flight altitude restricts the aircraft flight altitude, while maximum flight distance restricts the aircraft flight radius around the Home Point. These limits can be set using the DJI Pilot 2 app for improved flight safety.

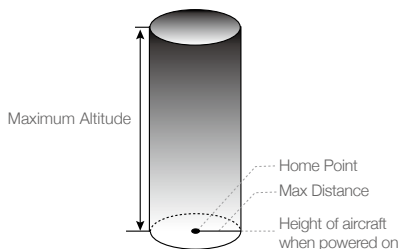

Home Point not manually updated during flight

Strong GNSS Signal		
	Restriction	Prompt in DJI Pilot 2
Max Altitude	Altitude of the aircraft cannot exceed the value set in DJI Pilot 2.	Aircraft approaching max flight altitude. Fly with caution.
Max Distance	The straight-line distance from the aircraft to the Home Point cannot exceed the max flight distance set in DJI Pilot 2.	Aircraft approaching max flight distance. Fly with caution.
Weak GNSS Signal		
	Restriction	Prompt in DJI Pilot 2
Max Altitude	When the GNSS signal is weak, namely when the GNSS icon is yellow or red, and the ambient light is too dark, the max altitude is 3 m (9.84 ft). The max altitude is the relative altitude measured by the infrared sensor. When the GNSS signal is weak but the ambient light is sufficient, the max altitude is 30 m (98.43 ft).	Aircraft approaching max flight altitude. Fly with caution.
Max Distance	No limit	N/A

- ⚠ • In the case where an aircraft exceeds a specified limit, the pilot can still control the aircraft but is unable to fly the aircraft any closer to the restricted area.
- For safety reasons, DO NOT fly aircraft near airports, highways, railway stations, metro stations, city centers, or other sensitive areas. Only fly the aircraft in areas that are within your direct line of sight.

## Calibrating the Compass

Only calibrate the compass when prompted to do so by the DJI Pilot 2 app or the aircraft rear indicators. Observe the following rules when calibrating the compass:

- DO NOT calibrate the compass in locations with strong magnetic interference, such as near magnets, parking lots, or construction sites with underground reinforced concrete structures.
- DO NOT carry ferromagnetic materials such as mobile phones during calibration.
- The DJI Pilot 2 app will display a prompt if the compass is affected by strong interference after calibration is complete. Follow the displayed instructions to resolve the compass issue.

### Calibration Procedure

Perform the calibration in an open area and follow the steps below to complete the calibration.

1. Run the DJI Pilot 2 app and enter camera view on the homepage. Tap ●●● and tap ⚙️, then go to Sensor Status, Compass, and Calibrate Compass to start the calibration. The aircraft rear indicators will glow in solid yellow, which indicates that the calibration has started.
2. Hold the aircraft horizontally 1.5 m (4.92 ft) above the ground and rotate the aircraft 360 degrees. The aircraft rear indicators will glow in solid green.

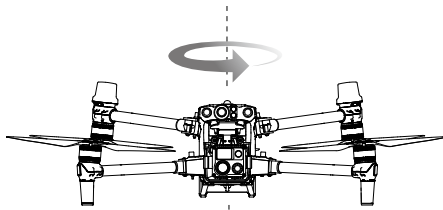

3. Hold the aircraft vertically with the nose pointing downward, and rotate the aircraft 360 degrees around the center axis.

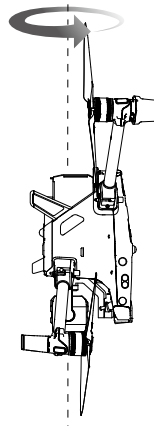

4. Re-calibrate the aircraft if the Aircraft Rear Indicators blink red.

 If the Aircraft Rear Indicators blink red and yellow alternately after the calibration is complete, it indicates strong interference in the current location. Move the aircraft to a different location and try again.

-  • A prompt will appear in DJI Pilot 2 if compass calibration is required before takeoff. The prompt will disappear after the calibration is complete.
- If the compass calibration is complete, place the aircraft on the ground. If the prompt appears again in DJI Pilot 2, try moving the aircraft to a different location before re-calibrating the compass.

### Three-Propeller Emergency Landing

During a flight, if one motor of the aircraft stops working due to a runtime failure, the aircraft will automatically switch to the Three-Propeller Emergency Landing mode. The flight controller system will try to maintain the stability and control of the aircraft attitude and velocity, and make the aircraft descend automatically in this mode. This allows sufficient time for the user to fly the aircraft to a safe area suitable for landing, avoiding a fall of the aircraft and its payloads from a high altitude, and preventing losses, personal injuries, and property damage on the ground.

When the aircraft enters the Three-Propeller Emergency Landing mode, the remote controller will vibrate to alert the user. At the same time, the aircraft will spin rapidly and automatically descend by default. The stick that controls the backward and forward movements of the aircraft will be adjusted to control movements in the north and south directions, and the stick controlling the left and right movements will be adjusted to control east and west. It is recommended to operate the sticks and move the aircraft to a safe location suitable for landing as soon as possible. When the aircraft approaches the ground, the user may enable the emergency propeller stop function to land the aircraft. Reducing the chances of the aircraft crashing or spinning and minimizing any losses.

-  • Three-Propeller Emergency Landing can only be used on an aircraft with a takeoff weight of  $\leq 3.78$  kg and at a flight altitude of  $\geq 10$  m (32.8 ft), in an open environment.
- Once such a failure occurs, move the aircraft immediately away from people and valuable property, and land the aircraft on level and soft ground, such as grass, to minimize any damage to the aircraft.
  - In the case where a propeller is damaged but the motor is still working properly, the aircraft will not enter the Three-Propeller Emergency Landing mode.
  - Three-Propeller Emergency Landing is only intended for emergency situations where the propulsion system has failed. DO NOT activate this function when there is no emergency.
  - This feature is constantly updated to cover more scenarios. Make sure that all firmware is up to date.
  - After an emergency landing, contact DJI Support for maintenance or repair of the propulsion system as soon as possible.

## DJI AirSense

Airplanes with an ADS-B transceiver will actively broadcast flight information including locations, flight paths, speeds, and altitudes. DJI aircraft incorporated with the DJI AirSense technology are capable of receiving flight information broadcast from ADS-B transceivers that comply with 1090ES or UAT standards within a radius range of 10 kilometers. Based on the received flight information, DJI AirSense can analyze and obtain the location, altitude, orientation, and velocity of the surrounding manned airplanes, and compare such figures with the current position, altitude, orientation, and velocity of the DJI aircraft to calculate in real time the potential risk of collision with the surrounding manned airplanes. DJI AirSense will then display a warning message in DJI Pilot 2 according to the risk level.

DJI AirSense only issues warning messages on approaches by specific manned airplanes under special circumstances. Always fly the aircraft within your visual line of sight and be cautious at all times to ensure flight safety. Please be aware that DJI AirSense has the following limitations:

1. DJI AirSense can only receive messages sent by airplanes installed with an ADS-B Out device that is in compliance with 1090ES (RTCA DO-260) or UAT (RTCA DO-282) standards. DJI devices cannot receive broadcast messages from or display warnings on airplanes not equipped with properly functioning ADS-B Out devices.
2. If there is an obstacle between a manned aircraft and a DJI aircraft, DJI AirSense will not be able to receive ADS-B messages from the aircraft or send warnings to the user. Keenly observe your surroundings and fly with caution.
3. Warning prompts may be sent with delay if DJI AirSense experiences any interference from the surrounding environment. Keenly observe your surroundings and fly with caution.
4. Warning prompts may not be received if the DJI aircraft is unable to obtain information on its own location.
5. DJI AirSense cannot receive ADS-B messages from manned airplanes or send warnings to the user when it is disabled or misconfigured.

When a risk is detected by the DJI AirSense system, the AR projection display will appear on the current view in DJI Pilot 2, intuitively showing the distance between the DJI aircraft and the airplane, and issuing a warning alert. Users should follow the instructions in DJI Pilot 2 upon receiving the alert.

- a. **Notice:** A blue airplane icon will appear on the map.
- b. **Caution:** The app will display the message: "Manned aircraft detected nearby. Fly with caution." A small orange square icon with the distance information will appear on the camera view, and an orange airplane icon will appear on the map view.
- c. **Warning:** The app will display the message: "Collision risk. Descend or ascend immediately." If the user is not operating, the app will display: "Collision risk. Fly with caution." A small red square icon with the distance information will appear on the camera view, and a red airplane icon will appear on the map view. The remote controller will vibrate to alert.

## Pre-Flight Checklist

The pre-flight checklist can be used as a reference for pre-flight check in daily operations.

1. Make sure the remote controller and the aircraft batteries are fully charged, the TB30 batteries are installed firmly, and the battery release toggles are locked.
2. Make sure the propellers are securely mounted and not damaged or deformed, that there are no foreign objects in or on the motors or propellers, that the propeller blades and arms are unfolded, and that the frame arm folding buttons are popped out in the locked position.
3. Make sure the lenses of the vision systems, cameras, FPV, the glass of the infrared sensors, and the auxiliary lights are clean and not blocked in any way.
4. Make sure the gimbal is unlocked and the camera is facing the front of the aircraft.
5. Make sure the covers of microSD card slot, the PSDK port, and the dongle compartment have been closed firmly.
6. Make sure the remote controller antennas are adjusted to the proper position.
7. Power on the aircraft and the remote controller, toggle the flight mode switch to N-mode. Make sure the status LED and the aircraft authority button on the remote controller are solid green. This indicates that the aircraft and the remote controller are linked and the remote controller is in control of the aircraft.
8. Place the aircraft on open and flat ground. Make sure there is no obstacles, buildings, or trees nearby, and that the aircraft is 5 m away from the pilot. The pilot should be facing the rear of the aircraft.
9. To ensure flight safety, enter the flight view of DJI Pilot and check the parameters on the pre-flight checklist such as the control stick mode, RTH height, obstacle distance, and failsafe settings. It is recommended to set the failsafe action to RTH.
10. Divide the airspace for flight when multiple aircraft are operating simultaneously in order to avoid collision mid-air.

# Aircraft

---

This chapter introduces the major features of the aircraft.

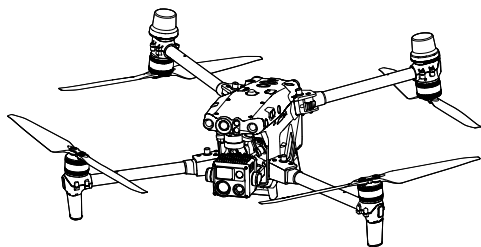



# Aircraft

The M30 Series aircraft mainly consists of the flight control system, communication system, vision system, image processing system, propulsion system, and power and battery system. This chapter provides a detailed introduction to the aircraft components and functions.

## Activating the Aircraft

After the aircraft is linked to the remote controller (make sure the remote controller is connected to the internet), the DJI Pilot 2 app will display the prompt: "There's a DJI device not activated". Follow the on-screen instructions to activate the aircraft. Contact DJI Support if the activation fails. Refer to the Link the Remote Controller section for details.

## Aircraft Overview

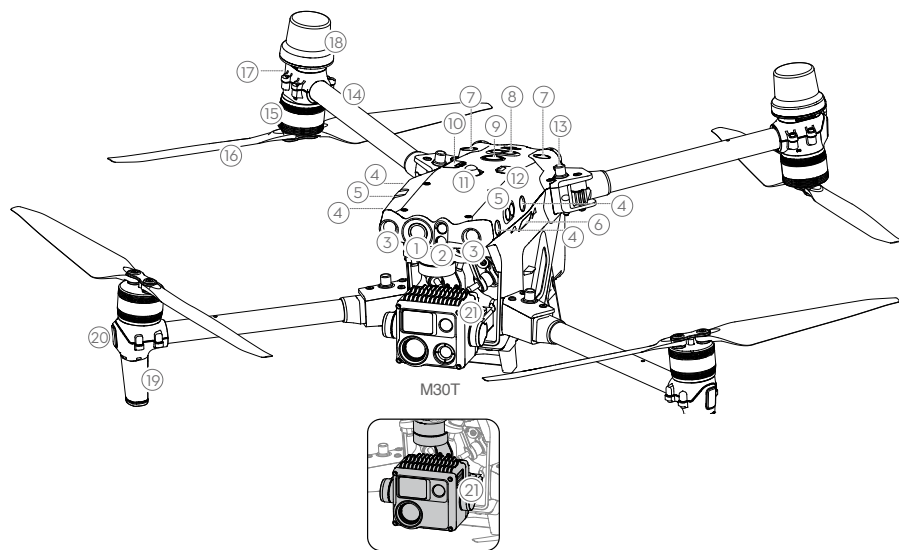

- |  |                                      |
|--|--------------------------------------|
| 1. FPV Camera                              | 13. Frame Arm Folding Buttons        |
| 2. Forward Infrared Sensing System         | 14. Frame Arms                       |
| 3. Forward Vision System                   | 15. Motors                           |
| 4. Left and Right Vision Systems           | 16. Propellers                       |
| 5. Left and Right Infrared Sensing Systems | 17. Aircraft Rear Indicators         |
| 6. microSD Card Slot                       | 18. GNSS Antennas                    |
| 7. Upward Vision System                    | 19. Video Transmission Antennas      |
| 8. Upward Infrared Sensing System          | 20. Aircraft Front Indicators        |
| 9. Power Button/Indicator                  | 21. Gimbal and Camera <sup>[1]</sup> |
| 10. PSDK Port                              |                                      |
| 11. Upward Beacon                          |                                      |
| 12. Assistant Port                         |                                      |

[1] The M30 and M30T are equipped with different cameras. Refer to the actual product purchased.

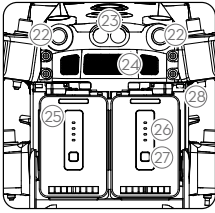

Rear View

- 22. Backward Vision System
- 23. Backward Infrared Sensing System
- 24. Air Vent
- 25. TB30 Intelligent Flight Battery
- 26. Battery Level LEDs
- 27. Battery Level Button
- 28. Battery Release Toggle

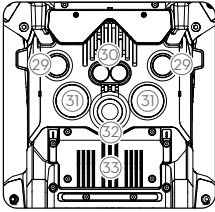

Bottom View

- 29. Downward Vision System
- 30. Downward Infrared Sensing System
- 31. Bottom Auxiliary Light
- 32. Downward Beacon
- 33. Dongle Compartment

---

 DO NOT disassemble the product without the assistance of a DJI authorized dealer (except for components allowed to be disassembled by users in this guide), otherwise it will not be covered under warranty.

---

## FPV Camera

The M30 Series aircraft is equipped with a starlight FPV camera, which can optimize images in poor lighting conditions at night. It helps the pilot to have better visibility of the flight environment and fly safely.

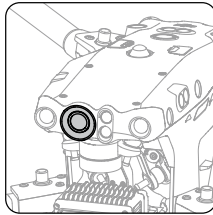

## Propellers

### Using the Propellers

The M30 Series aircraft supports both the 1671 Propeller and the 1676 High Altitude Propeller (excluded). Refer to the diagram below to choose the appropriate propellers according to the aircraft takeoff weight and the expected maximum flight altitude.

The service ceiling is the theoretical maximum altitude that the aircraft can fly at normally, on the condition that the wind speed does not exceed 15 m/s when flying and 12 m/s when taking off or landing. The aircraft braking and acceleration capabilities will be reduced when flying near the service ceiling. Use the 1676 High Altitude Propeller when flying at altitudes higher than 3,000 m (9,842.5 ft) above sea level.

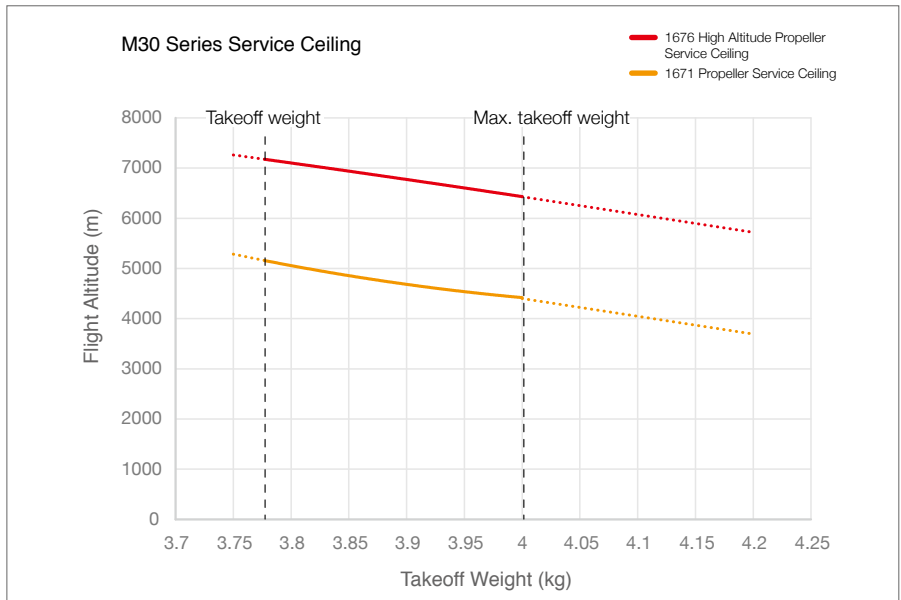

- ⚠ • Using high altitude propellers for extended periods may reduce motor life.
  - Only use official DJI propellers. DO NOT mix propeller types.
  - Propellers are consumable components. Purchase additional propellers if necessary.
  - Make sure that the propellers and motors are installed securely before each flight.
  - Make sure that all propellers are in good condition before each flight. DO NOT use aged, chipped, or broken propellers.
  - To avoid injury, stay away from rotating propellers or motors.
- 

### Storing the Propellers

Follow the diagram to fold and store the propellers.

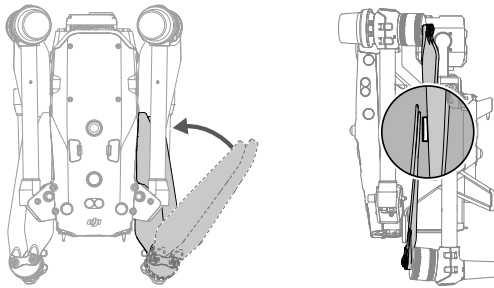

### Replacing the Propeller Blades

Use the H2.0 hex key to replace the propellers.

It is recommended to replace the propellers only in an emergency situation during operations. After the flight is over, contact DJI Support or an authorized dealer for propeller check and maintenance as soon as possible.

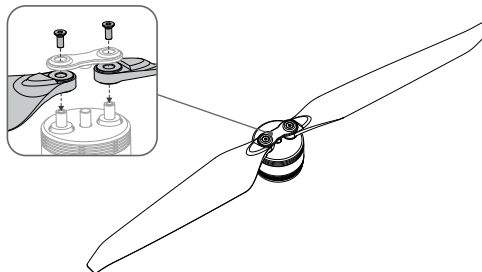







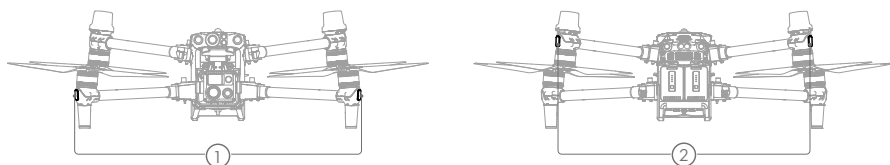





- 
- ⚠ The propeller blades are sharp. Handle with care.
-

## Aircraft Indicators

The aircraft has front and rear indicators. They can be turned off in DJI Pilot 2 for unobtrusive field operations.



1. Front Indicators: Blink green and red alternately to indicate the nose of the aircraft.
2. Rear Indicators: Blink green to indicate the rear of the aircraft when flying. When the aircraft is powered on but not in flight, the rear indicators will show the aircraft statuses. Refer to the table below for the different aircraft statuses.

Normal States		
 ×2	Blinks red, green, yellow in sequence twice	Powering on and performing self-diagnostic tests
 ·····	Blinks green*	Only GPS is used for positioning (RTK is not used)
 ×2 ·····	Blinks green twice*	Vision systems are used for positioning
 ·····	Blinks green and blue alternately	RTK enabled and RTK data is being used
 ·····	Blinks yellow slowly	Attitude mode (GNSS is not available)
Warning States		
 ·····	Blinks yellow quickly	Remote controller signal lost
 ·····	Blinks red slowly	Low battery level, takeoff is disabled **
 ·····	Blinks red quickly	Critically low battery level
 ·····	Blinks red for five seconds (when performing CSC)	IMU error
 — —	Solid red	Critical error
 ·····	Blinks red and yellow alternately	Compass calibration required
 ·····	Blinks red and green alternately	RTK enabled but RTK data unavailable

\* Blink green slowly in N-mode and fast in S-mode.

\*\* If the aircraft cannot takeoff while the rear indicator is blinking red slowly, connect to the remote controller, run DJI Pilot 2, and view the details.

## Aircraft Beacons

The upward and downward beacons on the aircraft enable you to find the aircraft when flying at night. The beacons can be manually turned on or off in DJI Pilot 2.

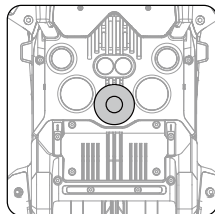
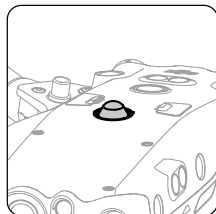

---

 DO NOT look directly at the beacons when they are in use to avoid damaging your eyes.

---

## Aircraft Auxiliary Lights

The auxiliary lights located at the bottom of the aircraft will automatically turn on in poor light conditions to assist the downward vision system. The lights can also be manually turn on or off in DJI Pilot 2.

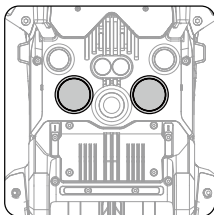

---

 The auxiliary lights will automatically turn on in low-light environments when the flight altitude is under 5 m. Note that the positioning performance of the vision systems may be affected. Fly with caution if the GNSS signal is weak.

---

## Gimbal Cameras

The M30 Series integrates a zoom camera and a wide camera, which enable users to quickly switch to a highly magnified zoom view for detailed observation after recognizing a target in the wide-angle camera view. M30T is also equipped with a long-wave infrared thermal imaging camera, which can shoot thermal images. Both the M30 and M30T feature a laser rangefinder, which can provide the location and distance information of a target during inspections or search-and-rescue operations. The operator can quickly pinpoint the location of the target and improve operation efficiency. The functions and usage with M30T as an example.

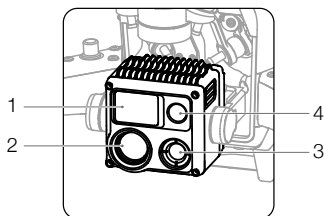

1. Laser Rangefinder
2. Zoom Camera
3. Thermal Camera (M30T only)
4. Wide Camera

## Operation

### Controlling the Camera with the Remote Controller

The following buttons and scroll wheel on the remote controller can be used to control the camera remotely.

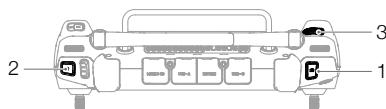

#### 1. Focus/Shutter Button

Press halfway down to auto-focus and press all the way down to take a photo. The photo mode can be set in DJI Pilot 2.

#### 2. Record Button

Press once to start or stop recording.

#### 3. Scroll Wheel

Scroll left or right to adjust camera zoom when used with M30 series aircraft.

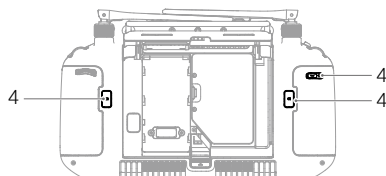

#### 4. C1/C2/C3 Buttons (customizable)

Run DJI Pilot 2 and enter camera view. Tap **...** and tap  to select Customize RC Buttons. Set the functions of the C1, C2, and C3 buttons for quick and easy control of the camera.

### Controlling the Camera with DJI Pilot 2

For information about how to control the camera in DJI Pilot 2, refer to the Gimbal Camera View section in the DJI Pilot 2 App chapter.

### Using the microSD Card

A 32 GB microSD card is in the microSD card slot when shipped. The aircraft supports microSD cards with a maximum capacity of up to 128 GB. To ensure that the camera can quickly read and write data for HD video recording, use a microSD card with UHS Speed Class 3 or above and a write speed greater than 30 MB/s.

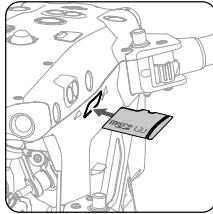

---

 The following microSD cards are recommended:

Lexar 667x U3 A2 Class10 32G/64G/128G

Lexar 1066x U3 A2 V30 32G/64G/128G

SanDisk Extreme PRO U3 A2 V30 32G/64G/128G

SanDisk Extreme U3 A2 V30 32G/64G/128G

- 
-  • Stop the recording first before removing the microSD card, to avoid losing the recorded videos.
- To ensure the stability of the camera system, the recording time for a single video is limited to 30 minutes. If the recording time exceeds 30 minutes, the video recording will stop and have to be restarted.
-



## Gimbal

The 3-axis gimbal stabilizes the camera, allowing the aircraft to capture clear and steady images and videos when in flight. Refer to the figure below for the tilt, pan, and roll range of the gimbal.

### Controllable Rotating Range

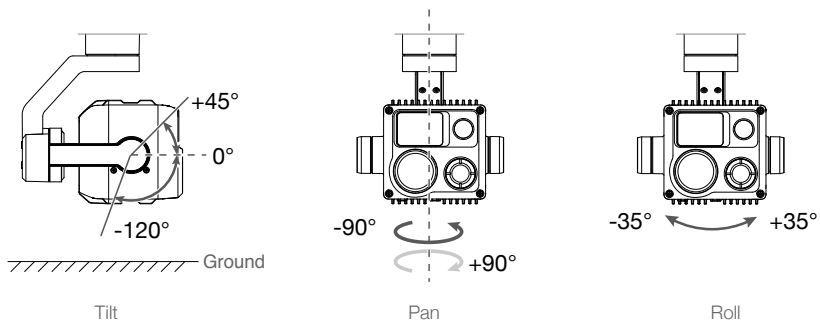

### Gimbal Lock

Rotate the gimbal tilt down to 0° to unlock the gimbal before use.

It is recommended to rotate the gimbal tilt up to +90° to lock the gimbal after use.

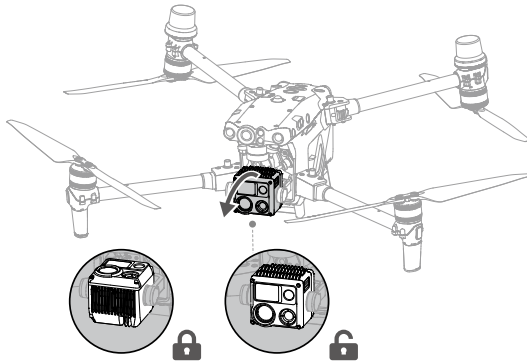

### Gimbal Operation

Controlling the Gimbal with the Remote Controller

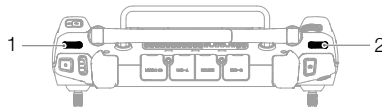

#### 1. Left Dial

The left dial controls the gimbal tilt. Dial left, the gimbal will tilt downwards. Dial right, the gimbal will tilt upwards.

#### 2. Right Dial

The right dial controls the gimbal pan. Dial left, the gimbal pan will rotate to the left. Dial right, the gimbal pan will rotate to the right.

Controlling the Gimbal with DJI Pilot 2



**Hold and Drag**

The user can control the gimbal in the gimbal camera view in DJI Pilot 2 as follows:

1. Launch DJI Pilot 2 and enter the gimbal camera view.
2. Tap anywhere on the screen and hold until a blue circle appears.
3. Drag the circle in any direction and the gimbal will rotate or tilt accordingly.

**Double Tap a Target to Center the Target**

Double tap a target in the gimbal camera view, and the target will be displayed at the center of the current view.



**Gimbal Mode**

The gimbal can work in two modes for different shooting needs.

	Follow Mode	When the aircraft rotates horizontally, the gimbal rotates accordingly with the angle between the gimbal pan and the aircraft heading unchanged.
	Free Mode	When the aircraft rotates horizontally, the gimbal orientation does not follow the rotation of the aircraft.

Users can use the gimbal mode icon in the gimbal camera view in DJI Pilot 2 to quickly control the gimbal and achieve the following:

	Gimbal Recenter	The gimbal pan rotates to the center to be consistent with the aircraft heading, and the gimbal tilt returns to the center (0°) from the current position.
--	-----------------	--

	Gimbal Down	The gimbal pan rotates to the center to be consistent with the aircraft heading, and the gimbal tilt changes to $-90^\circ$ from the current position.
	Gimbal Pan Recenter	The gimbal pan rotates to the center to be consistent with the aircraft heading while the gimbal tilt remains unchanged.
	Gimbal Tilt Down	The gimbal pan remains unchanged while the gimbal tilt changes to $-90^\circ$ from the current position.

---

 Make sure that there is nothing obstructing the gimbal's movements. DO NOT tap or knock the gimbal after the aircraft is powered on. Launch the aircraft from open and flat ground to protect the gimbal during takeoff.

---

## Aircraft RTK

### RTK Module Introduction

The built-in RTK module of the aircraft can withstand strong magnetic interference from metal structures and high-voltage lines, ensuring safe and stable flights. When used with a D-RTK 2 High Precision GNSS Mobile Station\* (excluded) or a DJI-approved Network RTK service, more accurate positioning data can be obtained.

\* Both D-RTK 2 High Precision GNSS Mobile Station and D-RTK 2 High Precision GNSS Mobile Station for Matrice Series are supported.

### Enabling/Disabling RTK

Ensure that the RTK function is enabled and RTK service type is correctly set (D-RTK 2 Mobile Station or Network RTK) before each use. Otherwise, RTK cannot be used for positioning. Go to the camera view in the DJI Pilot 2 app, tap **•••** and then select **RTK** to check the settings. Make sure to disable the RTK function if not in use. Otherwise, the aircraft will not be able to take off when there is no differential data.



- RTK positioning can be enabled and disabled during flight. Remember to select an RTK service type first.
- After RTK is enabled, Maintain Positioning Accuracy Mode can be used.

### D-RTK 2 High Precision GNSS Mobile Station

1. Refer to the D-RTK 2 High Precision GNSS Mobile Station User Guide (available from <https://www.dji.com/matrice-30/downloads>) to set up the D-RTK 2 Mobile Station and link the aircraft and the station. Power on the D-RTK 2 Mobile Station and switch to the Broadcast mode for the M30 Series.
2. In the RTK settings in the app, select "D-RTK 2 Mobile Station" as the RTK service type, connect to the mobile station by following the on-screen instructions, and wait for the system to search for a satellite. When the status of the aircraft's positioning in the status table shows "FIX", it indicates that the aircraft has obtained and used differential data from the mobile station.
3. D-RTK 2 Mobile Station communication distance: 12 km (NCC/FCC), 6 km (SRRC/CE/MIC).

### Custom Network RTK

To use Custom Network RTK, make sure that the remote controller has a Wi-Fi connection. Custom Network RTK can be used to replace the D-RTK 2 Mobile Station. Connect the Custom Network RTK account to the designated NTRIP server to send and receive differential data. Keep the remote controller turned on and connected to the internet when using this function.

1. Make sure that the remote controller is connected to the aircraft and the internet.
2. Go to the camera view in the DJI Pilot 2 app, tap **•••** and then select **RTK**. Select "Custom Network RTK" as the RTK service type and fill in the required information. Then tap "Save".
3. Wait to connect to the NTRIP server. In the RTK settings, when the status of the aircraft's positioning in the status table shows "FIX", it indicates that the aircraft has obtained and used differential data from Custom Network RTK.

## IP Rating

1. Under stable laboratory conditions, the M30/M30T achieves an IP55 protection rating by IEC 60529 standards when equipped with TB30 Intelligent Flight Batteries. The protection rating is not permanent, however, and may reduce over an extended period.
  - a. DO NOT fly when the amount of rainfall exceeds 100 mm in 24 hours.
  - b. DO NOT fold the frame arms in the rain. Make sure the aircraft is free of any liquid by wiping it carefully before storing in the carrying case.
  - c. Make sure the battery ports, battery compartment ports, battery surfaces, and battery compartment surfaces are dry before inserting the batteries.
  - d. Make sure the ports and surfaces of the battery are free from any liquid before charging.
  - e. The product warranty does not cover water damage.
2. The aircraft does not achieve IP55 protection rating in the following circumstances:
  - a. Frame arms are folded.
  - b. Batteries other than the M30/M30T TB30 Intelligent Flight Batteries are used.
  - c. The cover for the ports are not attached correctly.
  - d. The waterproofing top shell plug is not firmly attached to the top shell.
  - e. The aircraft is broken in situations such as where the aircraft shell is cracked or the waterproof adhesive is not secure.
3. The aircraft body uses flame retardant materials to improve safety performance, which may lead the color of the appearance to be changed. Such change does not affect the performance and the IP rating of the aircraft.

## PSDK Port

The PSDK port on the top of the aircraft enables developers to connect PSDK payloads and develop more expansion functions. Visit <https://developer.dji.com/> for more information about SDK development. Visit <https://www.dji.com/matrice-30/downloads> to learn more about the PSDK Mounting Bracket.

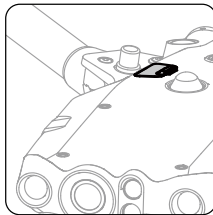

# Remote Controller

---

This chapter introduces the features of the remote controller and includes instructions for controlling the aircraft.

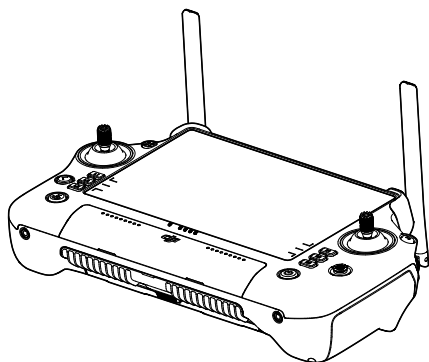

# Remote Controller

## Starting and Activating the Remote Controller

### Powering On/Off

Press once and then press again and hold for two seconds to power the remote controller on or off.

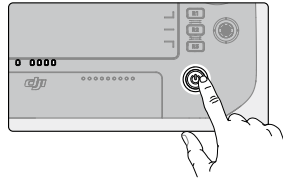

### Activating the Remote Controller



The remote controller needs to be activated before first use. Make sure the remote controller has access to the internet during activation.

Follow the steps below to activate the remote controller:

1. Power on the remote controller. Select a language option and tap Next. Read the Terms of Use and Privacy Policy carefully and tap Agree, then select your country/region.
2. Connect to a Wi-Fi network to access the internet. Then set the time zone, date, and time.
3. If you have a DJI account, log in with your password. If you are a new user, create a DJI account and log in.
4. After logging in, tap Activate on the activation interface.
5. A prompt will appear on the screen, indicating that the remote controller is activated.
6. After activating the remote controller, choose if you would like to join the DJI Product Improvement Project. Join this project to help DJI better understand your needs.



Check the internet connection if the activation fails. Make sure internet access is available and try activating the remote controller again. Contact DJI Support if the activation fails multiple times.



## Remote Controller Overview

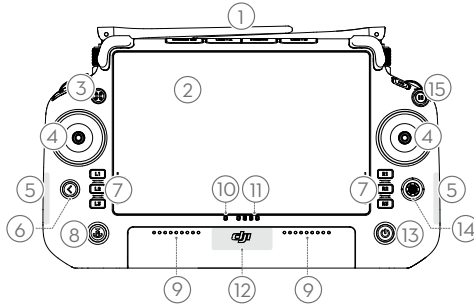

1. **External RC Antennas**  
Transmit control and video wireless signals between the remote controller and the aircraft.
2. **Touchscreen**  
Displays system and app views and supports up to 10 touch points. Make sure the touchscreen is clean, and completely dry before use. Otherwise, viewing and touch effects may be affected.
3. **Aircraft Authority Button**  
When flying with a M30 series aircraft, the aircraft authority button is used to take control of the aircraft and indicate the aircraft control status. Refer to Guide on the home screen for more information.
4. **Control Sticks**  
Flight control mode can be set in DJI Pilot 2.
5. **Internal Wi-Fi Antennas**  
DO NOT block the internal Wi-Fi antennas during usage. Otherwise, the signal may be affected.
6. **Back/Function Button**  
Press once to return to the previous screen. Press twice to return to the home screen. Use the back button and another button to activate combination buttons. Refer to the Combination Buttons section for more information.
7. **L1/L2/L3/R1/R2/R3 Buttons**  
Go to camera view in DJI Pilot 2 to view the specific functions of these buttons.
8. **Return to Home (RTH) Button**  
Press and hold to initiate RTH. Press again to cancel RTH.
9. **Microphone**  
DO NOT block the microphones during usage.
10. **Status LED**  
Indicates the status of the remote controller. View detailed descriptions of the Status LED in the Remote Controller LEDs and Alert section or in Guide on the home screen of the remote controller.
11. **Battery Level LEDs**  
Display the current battery level of the remote controller. View detailed descriptions of the Battery Level LEDs in the Remote Controller LEDs and Alert section.
12. **Internal GNSS Antennas**  
DO NOT block internal GNSS antennas during usage. Otherwise, the signal and the positioning accuracy may be affected.
13. **Power Button**  
Press once to check the current battery level. Press once, then press again and hold for two seconds to power the remote controller on or off. When the remote controller is powered on, press once to turn the touchscreen on or off.
14. **5D Button**  
View the default 5D button functions in DJI Pilot 2. Refer to Guide on the home screen for more information.

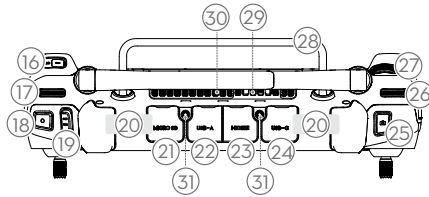

- 15. Flight Pause Button**  
Press once to have the aircraft brake and hover in place (only when GNSS or vision systems are available).
- 16. C3 Button**  
Customize functions in DJI Pilot 2.
- 17. Left Dial**  
Controls the tilt of the gimbal.
- 18. Record Button**  
Press once to start or stop recording.
- 19. Flight Mode Switch**  
For switching between three flight modes: N-mode (Normal), S-mode (Sport), and F-mode (Function). F-mode can be set to A-mode (Attitude) or T-mode (Tripod) in DJI Pilot 2.
- 20. Internal RC Antennas**  
Transmit aircraft control and video wireless signals. DO NOT block the internal RC antennas during usage. Otherwise, the signal may be affected.
- 21. microSD Card Slot**  
For inserting a microSD card.
- 22. USB-A Port**  
When flying with a Matrice series aircraft, users can connect the remote controller to a BS30 intelligent battery station for firmware updates. Users can also insert third-party devices, such as a USB flash drive or a memory card.
- 23. HDMI Port**  
For outputting HDMI signal to an external monitor.
- 24. USB-C Port**  
For charging the remote controller.
- 25. Focus/Shutter Button**  
Press the button halfway down for autofocus and all the way down to take a photo.
- 26. Right Dial**  
Controls the pan of the gimbal.
- 27. Scroll Wheel**  
For adjusting camera zoom.
- 28. Handle**
- 29. Speaker**
- 30. Air Vent**  
For heat dissipation. DO NOT block the air vent during usage.

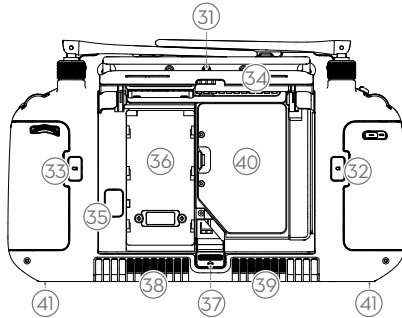

- |  |  |
|--|--|
| <p><b>31. Reserved Mounting Holes</b><br/>For mounting external devices.</p>           | <p><b>37. Rear Cover Release Button</b></p>  |
| <p><b>32. C1 Button</b><br/>Customize functions in DJI Pilot 2.</p>                    | <p><b>38. Alarm</b></p>  |
| <p><b>33. C2 Button</b><br/>Customize functions in DJI Pilot 2.</p>                    | <p><b>39. Air Intake</b><br/>For heat dissipation. DO NOT block the air intake during usage.</p> |
| <p><b>34. Rear Cover</b></p>   | <p><b>40. Dongle Compartment</b><br/>For inserting the dongle to the USB-C connector.</p>        |
| <p><b>35. Battery Release Button</b></p>   | <p><b>41. M4 Screw Hole</b><br/>For mounting the strap bracket.</p>                              |
| <p><b>36. Battery Compartment</b><br/>For installing the WB37 intelligent battery.</p> |  |

## Mounting the WB37 Intelligent Battery

A WB37 battery (excluded) can be mounted onto the remote controller in the following steps.

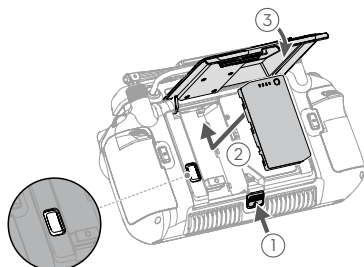

1. Push the rear cover release button to the end to open the rear cover.
2. Insert the WB37 battery into the battery compartment and push it to the top. There will be a clicking sound to indicate the battery is installed firmly.
3. Close the rear cover.

---

 To remove the WB37 battery, press and hold the battery release button and push the battery downward.

---

## Mounting the Dongle

The USB-C connector in the dongle compartment can be used to connect a USB-C dongle (excluded) in the following steps.

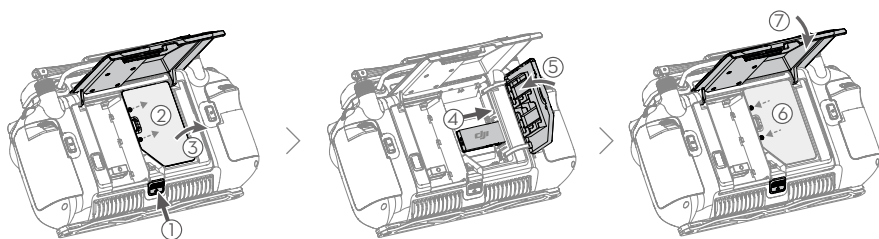

1. Push the rear cover release button to the end to open the rear cover. Remove the screws to open the dongle compartment.
2. Insert the dongle into the USB-C connector. Close the dongle compartment.
3. Attach the dongle compartment with the screws. Close the rear cover.

## Mounting the Strap and Bracket Kit

A strap and bracket (excluded) can be mounted onto the remote controller in the following steps.

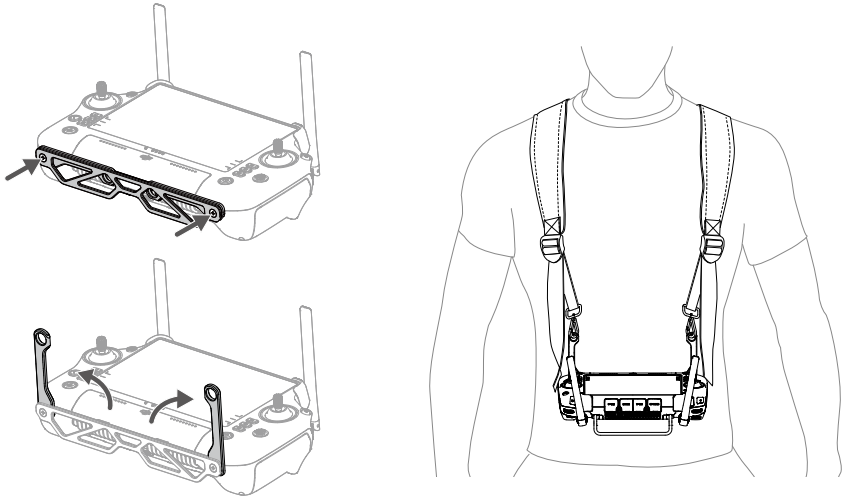

1. Mount the bracket on the remote controller with two screws.
2. Unfold the two handles.
3. Wear the strap, and attach the strap hooks to the handle holes.

---

 After use, hold the remote controller with one hand, unlock the strap hooks with the other hand to remove the remote controller, and then take off the strap.

---

## Adjusting the Antennas

Lift and adjust the antennas. The strength of the remote controller signal is affected by the position of the antennas.

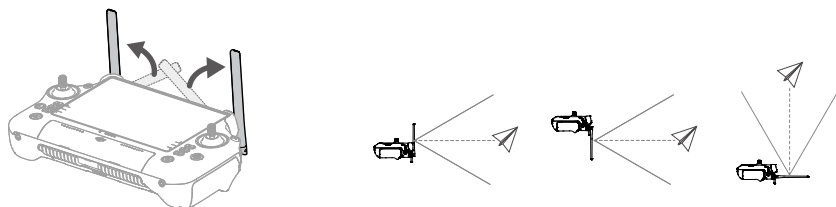

Adjust the direction of the external RC antennas and make sure their flat side is facing the aircraft, so that the controller and aircraft are within the optimal transmission zone.

- ⚠ • DO NOT overstretch the antennas, to avoid damage. Contact DJI Support to repair the remote controller if the antennas are damaged. A damaged antenna will greatly decrease the performance of the remote controller and might affect flight safety.
- During the flight, DO NOT use other 2.4 GHz or 5.8 GHz communication devices in the same frequency band at the same time, so as not to interfere with the communication signal of the remote controller. Such as enable the mobile phone Wi-Fi.
- A prompt will appear in DJI Pilot 2 if the transmission signal is weak during flight. Adjust the antennas to make sure that the aircraft is in the optimal transmission range.

## IP Rating

1. The DJI RC Plus remote controller has been tested in a lab environment and rated IP54 in accordance with the global IEC 60529 standard. The protection rating is not permanent, however, and may lower over an extended period.
  - a. DO NOT use the remote controller when the precipitation exceeds 50 mm in 24 hours.
  - b. DO NOT open any cover in the rain, including the external port cover, remote controller rear cover, dongle compartment cover, or air vent and air intake covers. DO NOT mount or remove control sticks or antennas in the rain. Before opening any cover or removing the control sticks or antennas, move the remote controller indoors and make sure it is clean and completely dry.
  - c. When using the remote controller in the rain, make sure all covers are attached firmly and control sticks are screwed in place securely.
  - d. It is normal to have water stains around the port when opening the port cover after use. Wipe off water stains before using the external port.
  - e. The product warranty does not cover water damage.
2. The remote controller is not qualified for an IP54 rating in the following circumstances:
  - a. The cover of the external port is not attached firmly.
  - b. The remote controller rear cover is not attached firmly.

- c. The air vent and air intake covers are not installed firmly.
- d. The dongle compartment cover is not attached firmly.
- e. The control sticks are not screwed in place securely.
- f. Antennas are not screwed in place securely.
- g. The remote controller has suffered other damage such as a cracked shell or compromised waterproof adhesive.

## User Interface

### Home Screen

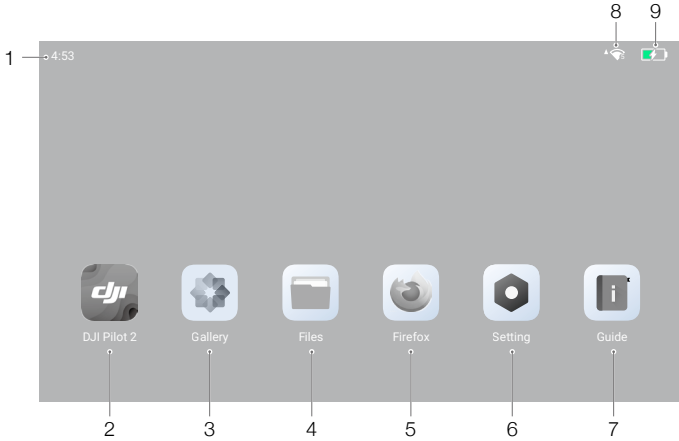

- 1. Time**  
Displays local time.
- 2. DJI Pilot 2**  
Tap to open DJI Pilot 2.
- 3. Gallery**  
Tap to view stored images and videos.
- 4. Files**  
Tap to view stored files.
- 5. Browser**  
Tap to open the browser.
- 6. Settings**  
Tap to open system settings.
- 7. Guide**  
Tap to read the guide with concise information on the remote controller buttons and LEDs.
- 8. Wi-Fi Signal**  
Displays Wi-Fi signal strength when connected to a Wi-Fi network. Wi-Fi can be enabled or disabled in the shortcut settings or in the system settings.
- 9. Battery Level**  
Displays the battery level of the internal battery of the remote controller. The battery level of the external WB37 intelligent battery will also be displayed when installed. The icon  indicates that the battery is charging.



### Screen Gestures

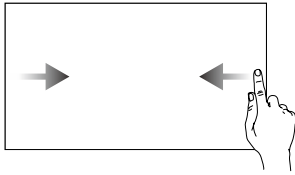

Slide from the left or right to the center of the screen to return to the previous screen.

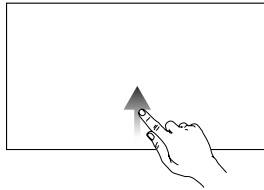



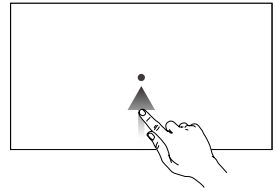



Slide up from the bottom of the screen to return to the home screen.

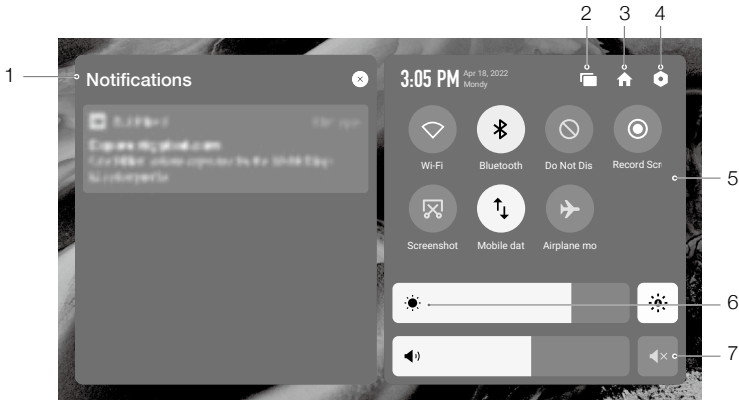



Slide up from the bottom of the screen and hold to access recently opened apps.

### Shortcut Settings



- 1. Notifications**  
View system or app notifications.
- 2. Recent**  
Tap  to view and switch to recently opened apps.
- 3. Home**  
Tap  to return to the home screen.
- 4. System Settings**  
Tap  to access system settings.
- 5. Shortcuts**
  -  : Tap to enable or disable Wi-Fi. Hold to enter settings and connect to or add a Wi-Fi network.
  -  : Tap to enable or disable Bluetooth. Tap and hold to open settings and connect with nearby Bluetooth devices.

 : Tap to enable DO NOT Disturb mode. In this mode, system prompts will be disabled.



 : Tap to start screen recording.

 : Tap to screenshot the screen.

 : Mobile data. Tap to turn mobile data on or off; long press to set mobile data and diagnose network connection status.

 : Tap to enable Airplane mode. Wi-Fi, Bluetooth, and mobile data will be disabled.

**6. Adjust Brightness**

Slide the bar to adjust the brightness. Tap the icon  to auto-brightness mode. Tap the  icon or slide the bar to switch to manual brightness mode.

**7. Adjust Volume**

Slide the bar to adjust the volume and tap  to mute. Note that after muting, all sounds of the remote controller will be completely disabled, including related alarm sounds. Please turn on the mute with caution.

## Video Transmission

M30 series aircraft feature O3 Enterprise, which enables triple-channel 1080p video transmission and supports Single Operator or Advanced Dual Operator mode.

1. When in Single Operator mode, the remote controller supports dual-channel 1080p video transmission.
2. When in Advanced Dual Operator mode, the remote controller supports triple-channel 1080p video transmission and allows seamless swapping between input feeds.

## Remote Controller LEDs and Alert

### Remote Controller LEDs

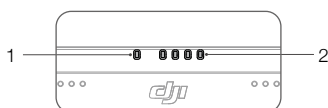

#### 1. Status LED

The status LED indicates the status of the remote controller, the aircraft, and the link between them.

Blinking Patterns	Descriptions
Solid red	Disconnected with aircraft
Blinking red	Low aircraft battery level
Solid green	Connected with aircraft
Blinking blue	The remote controller is linking to an aircraft
Solid yellow	Firmware update failed
Blinking yellow	Low remote controller battery level
Blinking cyan	Control sticks not centered

#### 2. Battery Level LEDs

The battery level LEDs indicate the battery level of the remote controller.

Battery Level Indicators				Battery Level
				75%~100%
				50%~75%
				25%~50%
				0%~25%

### Remote Controller Alert

The remote controller vibrates or beeps twice to indicate an error or warning. For detailed information, see the real-time prompts on the touchscreen or in DJI Pilot 2. Swipe down from the top of the screen

to open Shortcut Settings and turn on Mute mode to disable all voice alerts.

Any voice prompts and alerts will be disabled in Mute mode, including alerts during RTH and low battery alerts for the remote controller or aircraft. Use with caution.

## Charging the Remote Controller and Checking the Battery Level

### Charging the Remote Controller

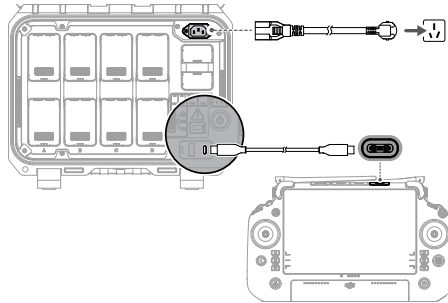

1. Connect the BS30 Intelligent Battery Station to a power outlet using the AC power adaptor cable.
2. Connect the battery station and the remote controller USB-C ports using a USB-C to USB-C cable.
3. The battery level LEDs start to flash to indicate that the Internal battery is activated.
4. It takes approximately 2 hours to fully charge the remote controller internal battery.



- It is recommended to use the DJI BS30 Battery Station for charging. Otherwise, use a certified USB-C charger with a maximum rated power of 65 W and maximum voltage of 20 V such as the DJI 65W Portable Charger.
- Fully discharge and charge the remote controller every three months. The battery depletes when stored for an extended period.
- If a WB37 battery is installed in the remote controller, the WB37 battery will be charged at the same time. The WB37 battery can also be charged by inserting to the BS30 battery station.



- The remote controller cannot be powered on before activating the internal battery.
- Make sure to use the included USB-C to USB-C cable for optimal charging.

### Charging Options

- A. The internal battery of the remote controller can be charged with a charging device or the inserted external WB37 battery. It takes approximately two hours to fully charge the internal battery with a charging device. The internal battery can be charged up to 50% with the external battery. Charging with the external battery is not possible after the remote controller is powered off.

B. Duration for fully charging a WB37 battery with 0% power:

- a. When mounted on the remote controller and the internal battery level is 0%, it takes approximately 2 hours while fully charging the internal battery.
- b. When mounted on the remote controller and the internal battery level is 100%, it takes approximately 1 hour and 10 minutes.
- c. When inserted into the BS30 battery station, it takes approximately 1 hour and 20 minutes.

 The charging time may vary with the ambient temperature.

---

### Charging Mechanism

- a. When the remote controller is connected with both a charging device and an external battery, the remote controller will be powered by the charging device.
- b. When the external battery is mounted and the remote controller is not connected with a charging device, the remote controller will be powered by the external battery. When the external battery is depleted, the remote controller will be powered by the internal battery.

### Checking the Battery Level

#### Checking the Internal Battery Level

Press the power button once to check the current battery level.

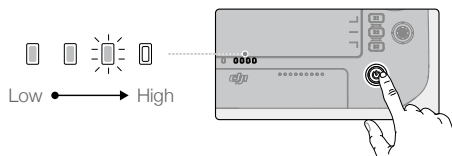

#### Checking the External Battery Level

Press the power button on the external battery, and the LEDs will indicate the current battery level of the external battery.

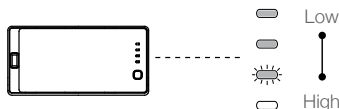

 Alternatively, go to the home screen of the remote controller and check the battery levels of both the internal and external batteries on the status bar.

---

## Linking the Remote Controller and Control Stick Modes

### Linking the Remote Controller

The remote controller is already linked to the aircraft when it is purchased together as part of a combo. Otherwise, follow the steps below to link the remote controller and the aircraft after activation.

#### Method 1: Using Combination Buttons

1. Power on the remote controller and the aircraft.
2. Press the C1, C2, and Record buttons simultaneously until the status LED blinks blue and the remote controller beeps twice.
3. Press and hold the power button on the aircraft for at least five seconds. The aircraft power indicator will blink and will beep twice to indicate linking has started. When linking is successful, the aircraft rear indicators will blink green while the remote controller will beep twice, and the remote controller status LEDs will turn solid green.

#### Method 2: Using DJI Pilot 2

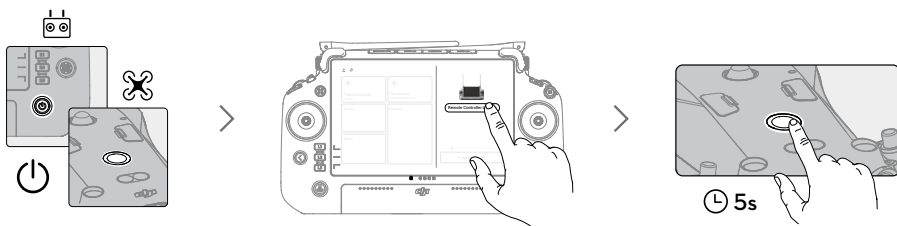

1. Power on the aircraft and the remote controller.
2. Run DJI Pilot 2 and tap Link Remote Controller to link. The status LED of the remote controller will blink blue, and the remote controller will beep during linking.
3. Press and hold the power button on the aircraft for at least five seconds. The aircraft power indicator will blink and will beep twice to indicate linking has started. When linking is successful, the aircraft rear indicators will blink green while the remote controller will beep twice, and the remote controller status LEDs will turn solid green.



- Make sure the remote controller is within 50 cm (1.6 ft) of the aircraft during linking.
- Make sure the remote controller is connected to the internet when logging in using a DJI account.

## Control Stick Mode

There are three pre-programmed modes as well as custom modes that can be configured in DJI Pilot 2. The modes are Mode 1, Mode 2, and Mode 3.

### Mode 1

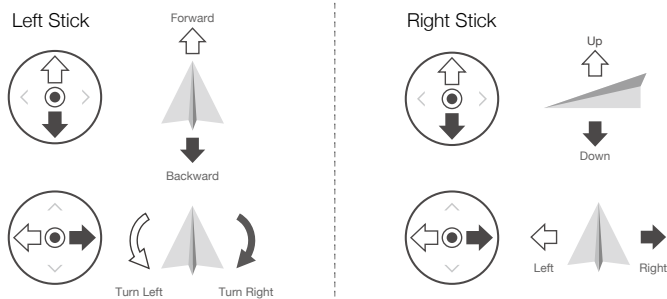

### Mode 2

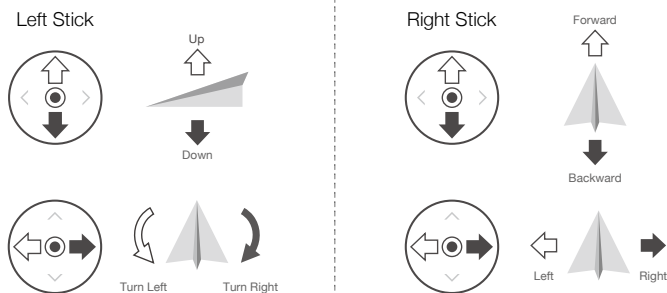



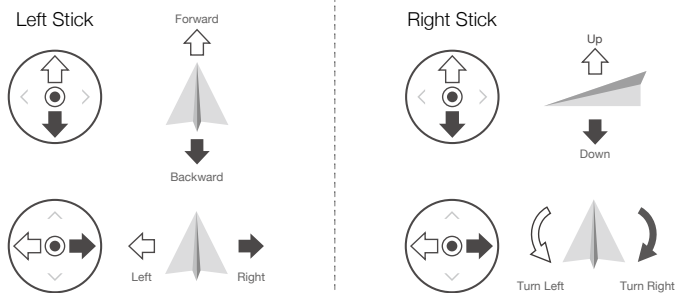



### Mode 3

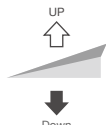

The default mode is Mode 2. See the figures below to check the function of each control stick in the three pre-programmed modes.

 Center position: control sticks are centered.

Moving the control stick: control sticks are pushed away from the center.

Remote Controller (Mode 2)	Aircraft	Remarks
<p>Left Stick</p> 		<p>Moving the left stick up or down changes the aircraft's altitude. Push the stick up to ascend and down to descend. The more the stick is pushed away from the center position, the faster the aircraft will change altitude. Push the stick gently to prevent sudden and unexpected changes in altitude.</p>
<p>Left Stick</p> 		<p>Moving the left stick to the left or right controls the orientation of the aircraft. Push the stick left to rotate the aircraft counter-clockwise and right to rotate the aircraft clockwise. The more the stick is pushed away from the center position, the faster the aircraft will rotate.</p>
<p>Right Stick</p> 		<p>Moving the right stick up and down changes the aircraft's pitch. Push the stick up to fly forward and down to fly backward. The more the stick is pushed away from the center position, the faster the aircraft will move.</p>
<p>Right Stick</p> 		<p>Moving the right stick to the left or right changes the aircraft's roll. Push the stick left to fly left and right to fly right. The more the stick is pushed away from the center position, the faster the aircraft will move.</p>

-  • Keep the remote controller away from magnetic materials such as magnets and loudspeaker boxes to avoid magnetic interference.
- To avoid damage to the control sticks, it is recommended that the remote controller be stored in the carrying case when being carried or transported.



## Buttons Overview

### RTH Button

Press and hold the RTH button until the remote controller beeps twice to start RTH. The aircraft will fly to the last updated Home Point. Press the button again to cancel RTH and regain control of the aircraft.

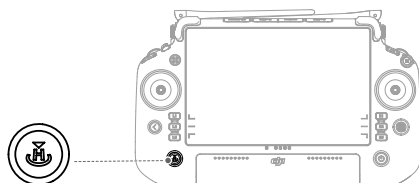

**⚠** In Advanced Dual Operator mode, the user cannot start or cancel RTH using the RTH button on the remote controller that does not have aircraft control.

### L1/L2/L3/R1/R2/R3 Buttons

The remote controller will automatically switch the functions of these buttons depending on the camera type on the aircraft. Find the descriptions of these button functions next to the L1/L2/L3/R1/R2/R3 buttons after running DJI Pilot 2.

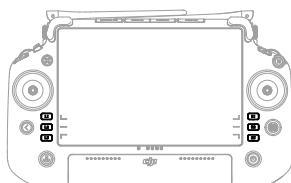

## Button Customization and Combinations

### Customizable Buttons

The C1, C2, C3, and 5D buttons are customizable. Open DJI Pilot 2 and enter camera view. Tap ... and tap  to configure the functions of these buttons. In addition, combination buttons can be customized using the C1, C2, and C3 buttons with the 5D button.

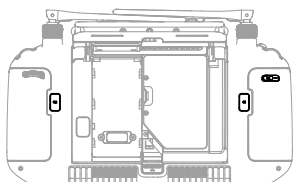

### Combination Buttons

Some frequently-used features can be activated by using combination buttons. To use combination buttons, hold the back button and operate the other button in the combination. In actual use, enter the home screen of the remote controller, and tap Guide to quickly check all available combination buttons.



The default combination buttons cannot be changed. The following table displays the function of each default combination button. Use the back button and the other button at the same time to execute a specific function.

Combination Operation	Function
Back Button + Left Dial	Adjust Brightness
Back Button + Right Dial	Adjust Volume
Back Button + Record Button	Record Screen
Back Button + Shutter Button	Screenshot
Back Button + 5D Button	Toggle up - Home; Toggle down - Shortcut settings; Toggle left - Recently opened apps

## Flight Mode Switch (N/S/F)

Toggle the switch to select a flight mode.

Icon	Flight Mode
F	F-mode (Function)
S	S-mode (Sport)
N	N-mode (Normal)

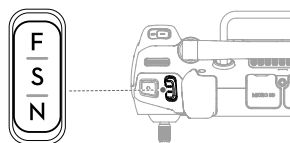

The flight controller system of the M30 series aircraft supports the following flight modes:

### N-mode (Normal)

The aircraft utilizes the GNSS and the vision system that allows for obstacle sensing in six directions to automatically stabilize itself. When the GNSS signal is strong, the aircraft uses the GNSS to locate and stabilize itself. When the GNSS signal is weak but the lighting and other environment conditions are sufficient, the aircraft uses the vision systems to locate and stabilize itself. When obstacle sensing is enabled and the lighting and other environment conditions are sufficient, the maximum tilt angle of the aircraft will be 25°. When the GNSS signal is weak and the lighting and other environment conditions are insufficient, the aircraft cannot hover precisely and can only maintain its altitude using the barometer.

### S-mode (Sport)

The aircraft utilizes the GNSS and downward vision system to hover precisely. By adjusting the gain and expo settings, the maximum flight speed of the aircraft can be increased to 23 m/s. When in S-mode, obstacle sensing in the four horizontal directions will be disabled, and the aircraft cannot detect or bypass obstacles in these directions. The upward and downward vision systems work normally in S-mode.

### F-mode (Function)

F-mode can be set to T-mode (Tripod mode) or A-mode (Attitude mode) in DJI Pilot 2. T-mode is based on N-mode. The flight speed is limited to allow easier control of the aircraft. Attitude mode must be used with caution.

-  • Obstacle sensing is disabled in S-mode, which means the aircraft cannot sense and brake to avoid obstacles automatically. Pay attention to the surrounding environment and obstacles on the route when flying the aircraft in S-mode.
- Please note that when flying in S-mode, the flight speed of the aircraft will greatly increase compared with that in N-mode (Normal). Accordingly, the braking distance will increase significantly. When flying in a windless environment, a minimum braking distance of 50 m (164 ft) is required.

### A-mode (Attitude mode)

- DO NOT switch from N-mode to either S-mode or F-mode unless you are sufficiently familiar with the aircraft behavior under each flight mode. You must turn on Multiple Flight Modes in DJI Pilot 2 before switching from N-mode to other modes.
- Avoid flying in areas where GNSS signal is weak or in narrow and confined spaces. Otherwise, the

aircraft will be forced to enter Attitude mode\*, leading to potential flight hazards. Land the aircraft in a safe place as soon as possible.

3. When switching the GNSS to the BeiDou satellite positioning system in DJI Pilot 2, the aircraft only uses a single positioning system and the satellite search capability becomes poor. Fly with caution.

\* In Attitude mode, the vision systems and some intelligent features are disabled. The aircraft cannot position itself or brake automatically in this mode and is easily affected by its surroundings, which may result in horizontal shifting. Use the remote controller to control and position the aircraft.

## Calibrating the Compass

The compass may need to be calibrated after the remote controller is used in areas with electromagnetic interference. A warning prompt will appear if the compass of the remote controller requires calibration. Tap the warning prompt to start calibration. In other cases, follow the steps below to calibrate the remote controller.

1. Enter the home screen.
2. Open Settings, swipe up, and select Compass.
3. Follow the diagram on the screen to calibrate the remote controller.
4. The user will receive a prompt when the calibration is successful.



If the remote controller compass is working normally, "Calibration Success" will be prompted after entering the calibration view. It is not necessary to perform the calibration.

## HDMI Settings

The touchscreen can be shared with a display screen via an HDMI cable. The resolution can be set in Settings, Display, Advanced, and then HDMI.

## Advanced Dual Operator Mode

M30 series aircraft support Advanced Dual Operator mode that allows two pilots to operate an aircraft simultaneously remote controllers A and B. In this mode, both remote controllers have equal control of the aircraft. The roles of both remote controllers operating the aircraft are not assigned in advance. Instead, either pilot may gain control of the aircraft or the gimbal camera as needed, allowing for more flexibility during the operation.

Control over the aircraft is independent of control over the gimbal camera. When a remote controller gains control of the aircraft or the gimbal camera, the user can use the controller to operate the aircraft or control the movement of the gimbal camera respectively.

### Setting the Advanced Dual Operator Mode

Before using Advanced Dual Operator mode, the pilot needs to link the aircraft with both remote controllers A and B. Follow the steps below to link the remote controllers.

1. Run the DJI Pilot 2 app.
2. Enter the homepage and tap Remote Controller A/B to activate linking. During linking, the status LED of the remote controller will blink blue and the remote controller will beep. Press and hold the power button on the aircraft for at least five seconds. The aircraft power indicator will blink and beep twice to indicate that linking has started. When linking is successful, the aircraft rear indicators will blink green, the remote controller beep twice, and the remote controller status LED turn solid green.
3. Thereafter, the aircraft control button on the remote controller with control of the aircraft will turn green, and the aircraft control button of the other remote controller will turn white. Tap  on the upper right corner of the gimbal camera view in DJI Pilot 2 to gain control of the gimbal camera.



Link the two remote controllers one by one. Make sure to link the remote controller A with the aircraft first, and then link the remote controller B.

## Using Advanced Dual Operator Mode

1. Make sure both remote controllers are linked and connected with the aircraft before using Advanced Dual Operator mode. By default, the first remote controller connected with the aircraft is granted control of both the aircraft and the gimbal camera, while the second remote controller is not given any control.
2. When a remote controller has control of a device, whether it is the aircraft or the gimbal camera, the pilot can control the device by pushing the control sticks, turning the dial, pressing the shortcut buttons, or tapping the app's user interface. The operation is the same as in Single Operator mode. However, when a remote controller does not have control of a device, the pilot is unable to control the device. Only the remote controller with aircraft control can be used to start or cancel RTH.
3. Either pilot can take over control of a device as needed. Press the aircraft control button to gain control of the aircraft. Tap  on the upper right corner of the gimbal camera view in DJI Pilot 2 to gain control of the gimbal camera. After gaining aircraft control, the pilot can lock it by pressing and holding the aircraft authority button on the remote controller. The aircraft authority button will turn blue when the control is locked. The control sticks are used for operating the gimbal if the remote controller only has control over the gimbal camera. When the remote controller has full control, the control sticks are used for controlling the aircraft and the dials for adjusting gimbal movement.
4. In Advanced Dual Operator mode, a control transfer mechanism will be triggered if one of the remote controllers is disconnected from the aircraft. When this happens, control of the gimbal camera will shift from the disconnected remote controller to the other remote controller still connected with the aircraft. If the disconnected remote controller also has aircraft control, the other remote controller will receive a notification that the user may manually take over aircraft control. If the pilot of the connected remote controller chooses not to take over aircraft control, the aircraft will automatically perform the failsafe action. If the pilot of the connected remote controller does not choose either option within a specified time period, the aircraft will also activate the failsafe action.
5. If the disconnected remote controller reconnects with the aircraft during the flight, it will not resume its previous control and will by default have no control of any device. The pilot may gain control of the devices again as needed.
6. Only the remote controller with control of the gimbal camera can be used to adjust relevant settings for the gimbal and camera, and to download or play back media files.
7. Only the remote controller with the control over gimbal camera can perform the download and playback operations of the gimbal camera.
8. Under normal circumstances, the pilots of both remote controllers can adjust flight-related settings, such as for the flight controller system, vision systems, batteries, and video transmission. However, if aircraft control is locked, only the remote controller with aircraft control can be used to adjust these settings.
9. Other non flight-related operations can be performed using either remote controller.
10. The pilot of remote controller B cannot adjust settings for network RTK or custom network RTK.
11. Remote controller A can be used to update the firmware of all modules at once when connected with the aircraft, but remote controller B can only be used to update the firmware of remote controller B.
12. Uploading Logs Using DJI Pilot 2: The pilot can upload the logs of both the aircraft and remote controller A through remote controller A, and can upload the logs of remote controller B through remote controller B.
13. Remote controller B cannot be used to update the GEO Zone database.

# Intelligent Battery Station

---

This chapter introduces the features of intelligent battery station.

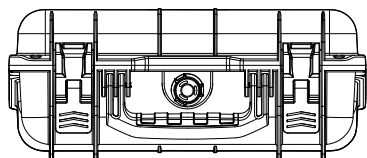

# Intelligent Battery Station

The BS30 Intelligent Battery Station features eight TB30 battery ports, two WB37 battery ports, one USB-C maintenance port, and one USB-A and one USB-C charging port. It can charge two TB30 batteries and one WB37 battery simultaneously.

## Battery Station Overview

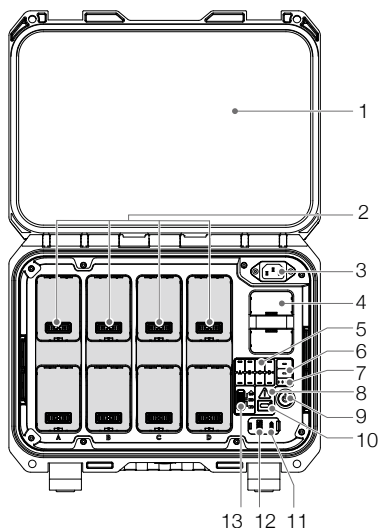

1. Cover
2. TB30 Battery Ports
3. Power Port
4. WB37 Battery Port
5. TB30 Battery Status LEDs
6. WB37 Battery Status LEDs
7. WB37 Battery Level LEDs
8. Battery Station Status LED
9. Power Button/Indicator
10. USB-C Maintenance Port
11. USB-C Charging Port (Recommended for Remote Controller)
12. USB-A Charging Port
13. Charging Mode Switch

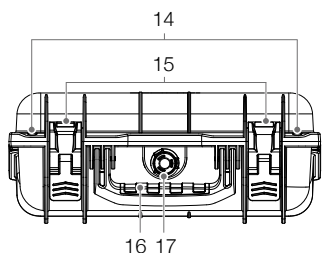

14. Padlock Holes
15. Lock Clip
16. Handle
17. Pressure Valve



## Warnings

1. Keep liquids away from the inside of the battery station.
2. DO NOT close the cover of the battery station during charging. Make sure it is well-ventilated and able to dissipate heat.
3. The battery station is only compatible with the TB30 battery and WB37 battery. DO NOT use the battery station with any other battery models.
4. Place the battery station on a flat and stable surface when in use. Make sure the device is properly insulated to prevent fire hazards.
5. DO NOT attempt to touch the metal terminals in the battery station. Clean the metal terminals with a clean, dry cloth if there is any noticeable buildup after powering off.
6. Take care to avoid injuring your fingers when opening or closing the battery station.

## Using the Battery Station

### Charging

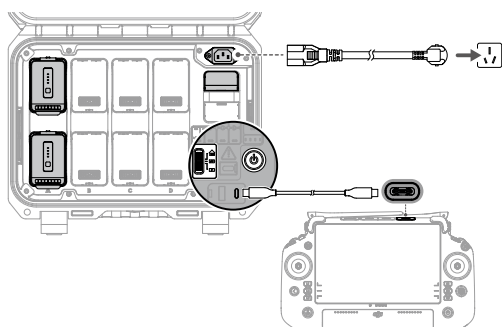

1. Connect the battery station to a power outlet using the AC power adaptor cable.
2. Press the power button once to power on the battery station.
3. To charge the DJI RC Plus remote controller, connect the USB-C ports of the battery station and remote controller using a USB-C to USB-C cable.
4. For TB30 batteries, make sure the charging mode is set to the mode required. The charging time is shown in the diagram.

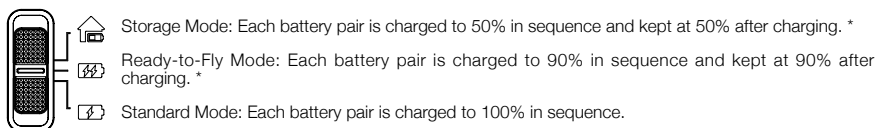

\* The battery station should be powered on to maintain the battery level in Storage Mode and Ready-to-Fly Mode. Power off the battery station after charging, except for special situations such as fire emergencies. Maintaining high power level in Ready-to-Fly Mode will affect battery life.

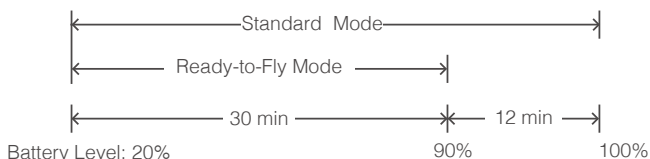

5. Insert the batteries into the battery ports to start charging.

A. For WB37 batteries, the battery station will charge the battery with the most power first.

B. For TB30 batteries, their charging sequence is illustrated below.

- Between paired and singular batteries, paired batteries will be charged first. (Figure a)
- Where there are multiple battery pairs (each formed by a top and bottom battery in the sequence of A, B, C and D), the pair with the highest power will be charged first. (Figure b)
- If none of the batteries are paired, the two batteries with the highest power will be charged first. (Figure c)

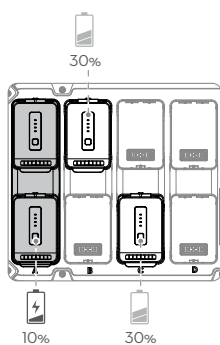

(Figure a)

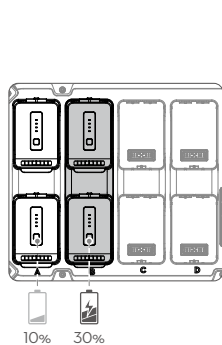

(Figure b)

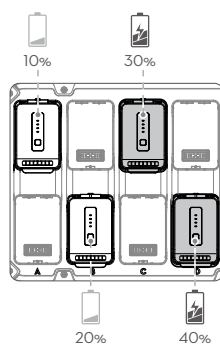

(Figure c)

⚡ Will charge first.



- When the power of the paired batteries are not the same, the battery station will charge the one with less power first.
- Connect the maintenance port to the remote controller USB-A port to update the firmware or diagnose the errors for battery station and batteries.



- The battery station will automatically warm up a TB30 battery to 18° C (64.4° F) before charging if the temperature of the battery is lower than 10° C (50° F) when inserted.
- When the WB37 battery is charged at the same time, the TB30 battery charging time will be slightly prolonged.



### Warming up and charging the battery at a low temperature

If the temperature of the battery is lower than 10° C (50° F) when inserted, the battery station will warm up the battery after being powered on.

 DO NOT charge in a low-temperature environment frequently. It may prolong the charging time and shorten battery life.

## Battery Station LEDs and Alert

### Battery Station LEDs Description

LED Indicators	Descriptions
<b>Power Button</b>	
Solid green	Powered on
<b>Battery Status LEDs </b>	
Blinks green	Charging
Solid green	Charging completed
Blinking yellow	Cooling down or warming up before charging
Solid yellow	Waiting to charge
Blinking red	Battery port communication error. Reinsert the battery or try another battery port.
Solid red	Battery error*
<b>Battery Station Status LED </b>	
Blinking yellow	Updating battery station firmware
Solid red	Battery station error*

\* Connect to the remote controller, run DJI Pilot 2, and tap HMS to diagnose the error.

### Buzzer Sound Description

The buzzer beeps to indicate the following errors:

- a. When the battery status LED is red and the buzzer is beeping, it means there is an error with the battery.
- b. When the battery station status LED is red and the buzzer is beeping, it means there is an error with the battery station.

# Intelligent Flight Battery

---

This chapter introduces the features of intelligent flight battery.

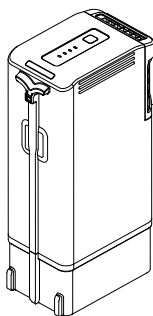

# Intelligent Flight Battery

## Introduction

The TB30 intelligent flight battery is equipped with high-energy battery cells and uses an advanced battery management system to power the aircraft. Only use a DJI-approved charging device to charge the intelligent flight battery. Make sure to fully charge the intelligent flight battery before using it for the first time. The firmware for the intelligent flight battery is included in the aircraft firmware. Make sure the firmware of all intelligent flight batteries is updated to the latest version.

## Battery Features

The intelligent flight battery has the following features:

1. **Battery Level Display:** The battery level LEDs display the current battery level.
2. **Battery self-discharge** will be triggered if the battery level is higher than 50%. Discharging the battery level to 50% can extend battery life.
3. **Balanced Charging:** During charging, the voltages of the battery cells are automatically balanced.
4. **Overcharge Protection:** The battery stops charging automatically once fully charged.
5. **Temperature Detection:** To prevent any damage, the battery only charges when the temperature is between -20° and 40° C (-4° and 104° F).
6. **Overcurrent Protection:** The battery stops charging if an excess current is detected.
7. **Over-Discharge Protection:** During flight, to ensure flight safety and allow users to have as much time as possible to deal with emergencies, over-discharge protection is disabled to allow continuous output. Therefore, pay attention to the remaining battery level during flight and land or return to home immediately when prompted to do so in the app. Otherwise, the battery may be dangerously over-discharged. When charging, an over-discharged battery may be a fire hazard. To prevent this, the battery will be locked and can no longer be charged or used.
8. **Short Circuit Protection:** The power supply is automatically cut if a short circuit is detected.
9. **Battery Cell Damage Protection:** The app will display a warning prompt when a damaged battery cell is detected.
10. **Hibernation Mode:** The battery will be in Hibernation mode when not in use to save power.
11. **Communication:** Information about the voltage, battery level, and current of the battery is transmitted to the aircraft.
12. **Heating:** The feature ensures the battery operates normally at a low temperature. Refer to the “Warming the Battery” section for details.
13. **Waterproofing and Dustproofing:** After being installed in the aircraft, the battery meets the IP55 rating standards.



- Refer to the user manual, safety guidelines, and battery labels before use. Users shall take full responsibility for all operations and usage.
- If only one battery is usable after takeoff, land the aircraft promptly and replace the batteries.
- PSDK port has a built-in temperature sensor. If the payload power is too large causing the device to overheat, the aircraft will automatically cut off power supply for the payload.
- Use batteries provided by DJI. DO NOT use other batteries.

## Using Paired Batteries

Label the two batteries with paired battery stickers before use. Charge and discharge the two batteries together to optimize flight performance and maximize battery life. After the batteries are inserted and the aircraft is powered on, if there is a huge difference between their battery life, the app will display a prompt alerting the user to such condition of the batteries. In this case, it is recommended to replace them with batteries with similar performance before use.

## Powering On/Off

Install the batteries in the aircraft before powering on or off.

Power on/off: Press the power button, then press again and hold for two seconds. The power button/indicator glows solid after the aircraft is powered on. The power button/indicator turns off after the aircraft is powered off.

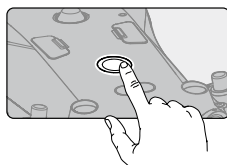

## Checking Battery Level

Press the battery level button to check the current battery level when the power supply is off. After turning on the power, check the current battery level in the top bar of the app.

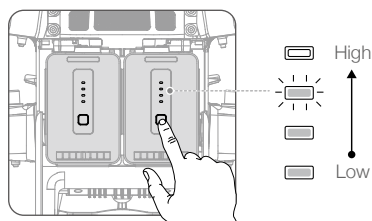

































 The Battery Level Indicators will also show the current battery level during discharging. The indicators are defined below.

 : LED is on.

 : LED is off.

 : LED is flashing.

Battery Level				
LED1	LED2	LED3	LED4	Battery Level
				88%~100%
				75%~88%
				63%~75%
				50%~63%
				38%~50%
				25%~38%
				13%~25%
				0%~13%

## Hot Battery Replacement

After landing, the aircraft does not have to be powered off for replacement of its batteries. First, insert a fully charged battery and wait for three seconds before inserting another battery.

## Warming the Battery

The battery has a built-in self-heating feature for when operating in low-temperature conditions:

1. When the battery temperature is lower than 18° C (64.4° F), self-heating starts once it is inserted into the aircraft and powered on. Self-heating will turn off automatically after aircraft takeoff. When the battery temperature is lower than 10° C (50° F), the aircraft will not take off. Wait until the battery is warmed up before operating the aircraft.
2. If the battery is not inserted in the aircraft, press and hold the battery level button for 5 seconds to initiate self-heating. The battery will continue to keep warm with a temperature between 15° and 20° C (59° and 68° F) for approximately 30 minutes. Press and hold the battery level button for 5 seconds to stop self-heating.
3. If the battery is at a temperature below 10° C (50° F), the battery station will warm up the battery once it is inserted in the powered on battery station.
4. The battery level LEDs will blink as follows when the battery is warming up and keeping warm.

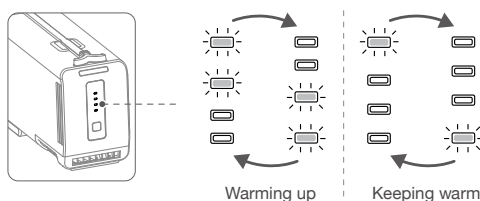

### Notes for operating at low temperatures

1. At a temperature below 10° C (50° F), battery resistance increases and voltage decreases significantly, which in turn reduces battery capacity and performance. Make sure that the battery is fully charged and the cell voltage is 4.4 V before use.
2. When the aircraft is in flight after the above conditions are satisfied, and the DJI Pilot 2 app shows a critically low battery level warning, it is recommended to stop flying immediately and land the aircraft in an appropriate place. During auto landing, users can still use the remote controller to control the aircraft's orientation. For example, users can push the throttle stick to lift the aircraft.
3. At extremely cold temperatures, the battery's temperature may not be high enough for it to operate even after warming up. In such scenarios, increase the insulation of the battery.
4. To ensure optimal performance, keep the temperature of the batteries above 18°C (64.4° F) before flight.
5. At low temperatures, the preheating period may be longer. It is recommended to insulate the batteries in advance to shorten the preheating period.

## Battery Storage

- Battery self-discharge will be triggered if the battery level is higher than 50%. Discharging the battery level to 50% can extend battery life. The battery self-discharge strategy is shown below.

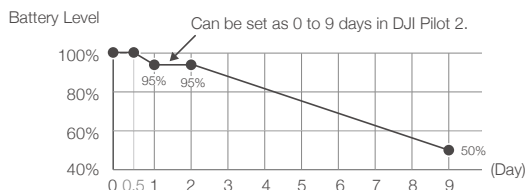

- Storing power at proper levels can extend battery life. Use Storage Mode of the battery station to charge the power to and store it at 50%. Refer to the table below for the maximum storage days when battery power is below 50%.

Battery level	Maximum storage days	Battery level	Maximum storage days
0%	12	20%	110
5%	36	30%	160
10%	60	40%	210
15%	86	50%	260

- The battery will be damaged once it exceeds the maximum storage period. The battery should no longer be used.
- The actual maximum storage period will vary slightly due to the batteries being part of different production batches and stored in different environments.

## Battery Maintenance

### Capacity Calibration

- Follow the steps to complete capacity calibration when prompted to do so by DJI Pilot 2.

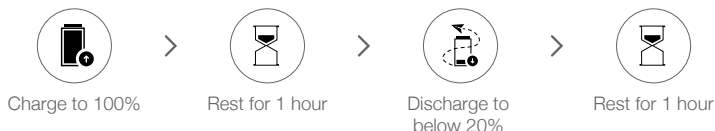

### Battery Maintenance

- Battery performance will be affected if the battery is not used for an extended period.
- Perform battery maintenance once every 50 cycles or 3 months or when prompted to do so by DJI Pilot 2, in the following steps:

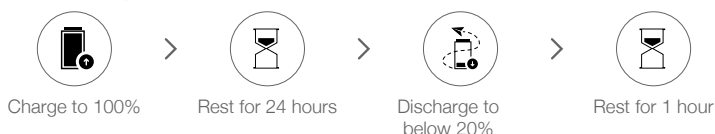



Charge the battery fully or to the proper power level for storage after completing battery maintenance. Contact DJI Support if a maintenance failure persists.

In addition to the above, we recommend conducting the following checks for battery maintenance:

- a. Insert the battery into the aircraft and power it on to view the battery information in DJI Pilot 2. Make sure the difference in cell voltage is less than 0.1 V and the battery firmware is updated to the latest version.
- b. Make sure the battery is not swollen, leaky, or damaged.
- c. Make sure the battery terminals are clean.

# DJI Pilot 2 App

---

This chapter introduces the main functions of the DJI Pilot 2 app.

# DJI Pilot 2 App

The DJI Pilot 2 app is specifically developed for enterprise users. Manual flight integrates a variety of professional features that make flying simple and intuitive. Mission flight supports flight planning and autonomous operation of the aircraft, making your workflow much simpler and more efficient.

## Homepage

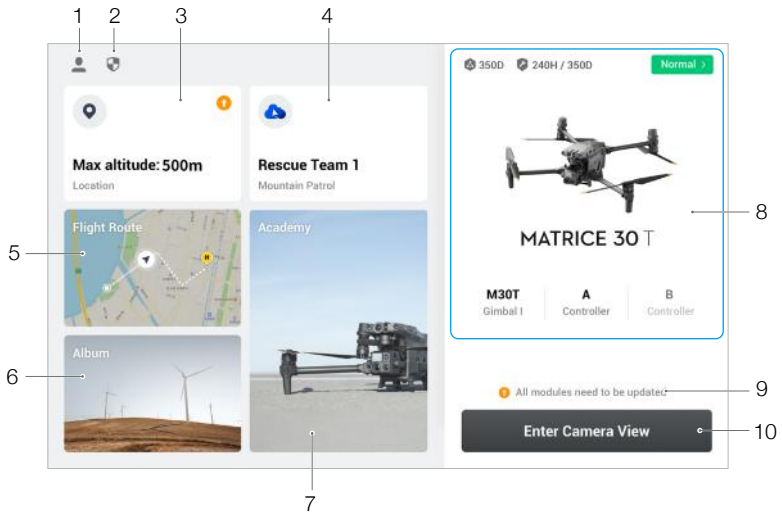

### 1. Me

Tap to view flight records, download offline maps, manage GEO Zone unlocking, read help documentation, select a language, and view app information.

### 2. Data and Privacy

Tap to manage network security modes, set security codes, manage app cache, and clear DJI device logs.

### 3. GEO Zone Map

Tap to view the GEO Zone map, check offline whether the current operating area is in a restricted zone or authorization zone, and the current flyable altitude.

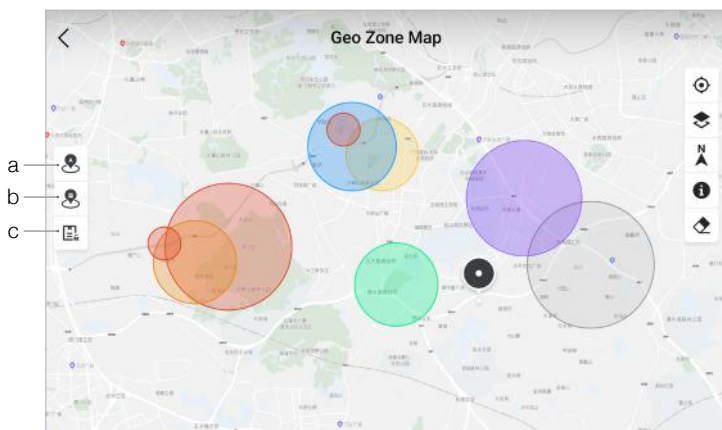

- a. Tap to update the GEO Zone database of the aircraft, if an update is available.
- b. Tap to update the GEO Zone database of the remote controller, if an update is available.
- c. Tap to enter and manage the unlocking certificate. If the aircraft is already connected to the remote controller, users can select the unlocking certificate directly to unlock the aircraft.

#### 4. Cloud Service

Tap to enter the cloud service page, view the connection status of the cloud service, select the type of service, or switch from the currently connected service to another cloud service.

- a. If the DJI account logged in by the user has the DJI FlightHub 2 license, tap the cloud service on the app homepage to automatically log in to DJI FlightHub 2. DJI FlightHub 2 is a cloud-based integrated online management platform for aircraft, providing users with real-time aircraft monitoring and equipment and member management.

Visit the DJI FlightHub 2 page on the DJI official website for more information:

<https://www.dji.com/flighthub-2>

- b. If connected to the GB28181 service, GB28181 and its connection status will be displayed.
- c. If connected to a live service such as RTMP or RTSP, the corresponding live URL and connection status will be displayed.

---

 If the service is connected, the font will be displayed in dark black; if it is connecting, a connecting prompt will appear in the upper right corner of the cloud service; if it is offline or disconnected, an orange icon will appear in the upper right corner of the cloud service as an abnormal alert.

---

#### 5. Mission Flight

Tap to enter the mission flight library. Users can create and view all mission flights. Mission flights can be imported from and exported in batches to the remote controller or another external mobile

storage device. If DJI FlightHub 2 is connected, you can also view all mission flights sent from or upload local tasks to the cloud. Refer to the Mission Flight section for more details.

### 6. Album

Tap to view your masterpieces all in one place. You can save the photos or videos to the remote controller. Note that photos and videos cannot be viewed if disconnected from the aircraft.

### 7. Academy

Tap to view enterprise product tutorials, flight guides, industry cases, and download product manuals to the remote controller.

### 8. Health Management System

Displays the health status of the aircraft, remote controller, and payload.

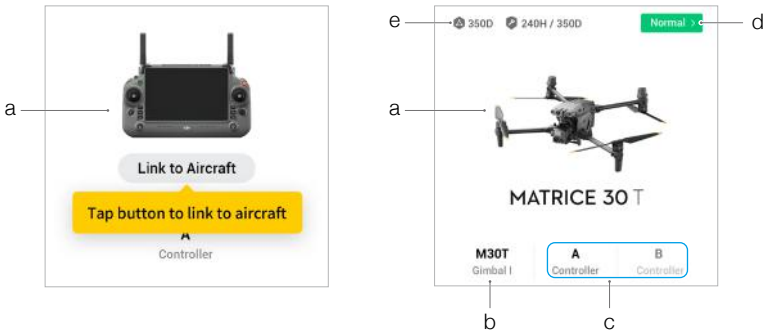

- a. If the current remote controller is not connected to the aircraft, the picture of the remote controller will be displayed. Tap to link the remote controller to the aircraft, and the aircraft model and picture will be displayed after it is connected.
- b. If the payload is abnormal, the payload name will appear in orange or red. Tap to view the error information on the payload.
- c. The current remote controller role is displayed as A or B (the role name of the current remote controller appears in dark black). Tap to view the error information on the remote controller or switch the remote controller role.
- d. Tap to enter the health management system. The health status of the aircraft and the remote controller is displayed here. If it appears in green (normal), the aircraft is normal and can take off. If in orange (caution) or red (warning), the aircraft has an error and must be checked and cleared before takeoff. Read the Health Management System (HMS) section for more details.
- e. The maintenance information of the current aircraft is displayed here. If the aircraft has DJI

Care, its validity period will also be shown. Tap to view the device information, including cycle count, flight duration, flight history, activation time, and flight mileage.

### 9. Firmware Update Shortcut

If an update is necessary, a prompt will appear notifying the user that new firmware is available or a consistent firmware update is needed for the aircraft and remote controller.

Inconsistent firmware versions will affect flight safety, therefore the app will prioritize consistent firmware updates. Tap the prompt to enter the firmware update page.



A consistent firmware update is required when the firmware versions of some modules of the aircraft are inconsistent with the compatible version of the system. In a typical consistent firmware update situation, the aircraft and remote controller will be updated to the latest version except for extra batteries. When these batteries are used, a prompt will appear requiring a consistent firmware update to ensure flight safety.

---

### 10. Camera View

Tap to enter Preflight Check view and FPV camera view and switch to gimbal camera view. Refer to the Preflight Check View, FPV Camera View and Gimbal Camera View sections for more details.

## Preflight Check View

Tap Enter Camera View on the homepage of DJI Pilot 2 to enter Preflight Check view.

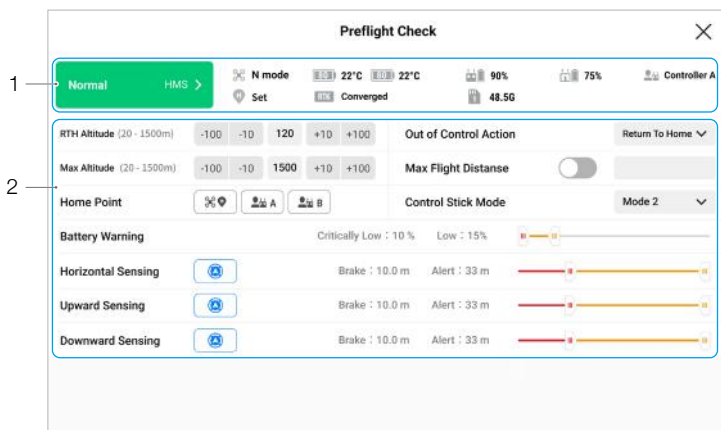

1. View the aircraft's health information, flight mode, intelligent flight battery level, remote controller role, remote controller internal and external battery levels, Home Point status, RTK status, and camera microSD card storage information.
2. Set the return-to-home altitude, out-of-control action, maximum altitude and maximum flight distance, update the Home Point, select the control stick mode, and set the battery warning threshold, obstacle sensing switches and obstacle sensing distances.



- It is recommended to carefully conduct the preflight check according to the operation scenario and requirements before takeoff.
- Before executing a mission flight, conduct a preflight check and verify the basic parameter information of the mission flight. Refer to the Mission Flight section for details.

## FPV Camera View

### Using FPV Camera View

After tapping Enter Camera View on the homepage of DJI Pilot 2 and finishing the preflight check, you will be directed to FPV camera view by default.



1. Top Bar: displays the aircraft status, flight mode, signal quality, etc. Refer to the Top Bar section for more details.
2. Discreet Mode Switch: Tap to turn off the aircraft rear indicators and front indicators, beacons, auxiliary light, and battery indicators. After enabling Discreet Mode, the auxiliary light will not turn on during landing, which may present certain risks. Use Discreet Mode with caution.
3. Beacons Switch: Press the L1 button on the remote controller to turn the beacons on or off.
4. Switch to Map View: Press the L3 button on the remote controller to switch to map view.
5. Map View: Users can maximize or minimize the map. The map view supports zooming in and out.
6. Gimbal Camera View: Tap to switch to gimbal camera view. The gimbal camera view supports zooming in and out.
7. Switch to Gimbal Camera View: Press the R3 button on the remote controller to switch to gimbal camera view.
8. AR Projection: projects information such as PinPoints, waypoints, and the Home Point in FPV camera view and gimbal camera view to improve flight perception. Refer to the AR Projection section for more details.
9. Primary Flight Display (PFD): shows parameters such as attitude, speed, altitude, and wind speed during a flight. Refer to the Primary Flight Display (PFD) section for more details.



### Primary Flight Display (PFD)

Primary Flight Display (PFD) makes flying easier and more intuitive, enabling users to see and avoid obstacles around the aircraft, as well as stop and adjust the flight trajectory if necessary.

Primary Flight Display may appear differently when the main view is through an FPV camera or gimbal camera (zoom camera/wide camera/thermal camera).



1. Speed wheel.
2. Wind speed and direction. The wind direction is relative to the aircraft.
3. Aircraft horizontal speed.
4. Preset speed of the flight route during the mission flight.
5. Artificial Horizon: reflects the attitude of the aircraft, which is opposite to its tilt angle.
6. Aircraft Heading Indicator: always in the middle of the camera view.
7. Flight Path Vector: the position the aircraft is about to reach.
8. Altitude Limit (LIM): configured by the flight controller setting.
9. Preset height of the flight route during the mission flight.
10. Vertical Obstacle Indicator: displays the vertical obstacle information of the aircraft. When there is an obstacle above or below the aircraft, the information can be compared with the height of the obstacle to detect any imminent collision and avoid accidents. When upward and downward sensing are disabled, OFF will be displayed to remind the user that vertical obstacle sensing is turned off.
11. Vertical Speed: displays the vertical speed of the aircraft when ascending or descending. The white line shows the position of the aircraft in three seconds. The higher the vertical speed, the longer the white line.
12. Altitude (ALT): displays the altitude of the aircraft relative to the takeoff point.

- 13. RTH Altitude (RTH): displays the RTH altitude configured by the flight controller setting.
- 14. Absolute Altitude (ASL): displays the absolute altitude of the aircraft.
- 15. Navigation Display: shows the aircraft and gimbal orientation, and obstacle avoidance information from a top-down perspective. Refer to the Navigation Display section for more details.

### Navigation Display

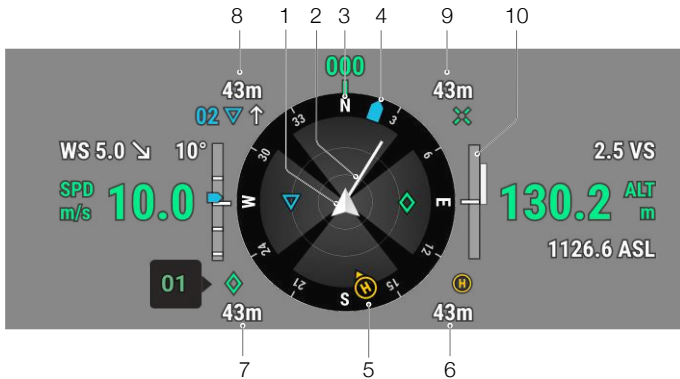

Navigation Display only shows the speed, altitude and other information on the left and right sides in gimbal camera view. In FPV camera view, such information is shown in the form of Primary Flight Display.

- 1. Aircraft: Navigation Display rotates with the aircraft.
- 2. Aircraft Horizontal Speed Vector: The white line drawn by the aircraft indicates the flight direction and speed of the aircraft.
- 3. Aircraft Orientation: displays the current orientation of the aircraft. The displayed degree is counted clockwise from the north, with the north assumed as 0 degrees and the step length being 30 degrees. For example, the number 24 in the compass indicates the heading of the aircraft after a 240-degree clockwise rotation from 0 degrees.
- 4. Gimbal Orientation: displays the orientation of the gimbal relative to the aircraft in real time. The icon rotates with the gimbal.
- 5. Home Point and Remote Controller Orientations:
  - a. Displays the home position relative to the aircraft. When the Home Point horizontal distance exceeds 16 m, the Home Point icon will stay on the edge of the Navigation Display.
  - b. When the relative distance between the Home Point and the remote controller is no more than 5 meters, only the Home Point will be displayed in Navigation Display. When the relative distance is more than 5 meters, the remote controller will be displayed as a blue dot to indicate its position. When the horizontal distance between the remote controller and the aircraft exceeds 16 meters, the remote controller position icon will stay on the edge of Navigation Display.

- c. When the compass of the remote controller is working normally, the blue dot shows the direction of the remote controller. If the signal is poor during flight, point the arrow of the remote controller in Navigation Display to the direction of the aircraft.
6. Home Point Distance: displays the horizontal distance between the Home Point and the aircraft.
7. PinPoint Information: displays the name of the PinPoint and the horizontal distance from the aircraft to the PinPoint, when PinPoint is enabled.
8. Waypoint Information: displays the name of the waypoint, the horizontal distance from the aircraft to the waypoint, and the ascending or descending trajectory of the flight route, during a mission flight.
9. RNG Target Point Information: displays the horizontal distance from the aircraft to the target point, when the RNG laser rangefinder is enabled.
10. Vertical Obstacle Sensing Information: Once an obstacle is detected in the vertical direction, an obstacle bar icon will appear. When the aircraft reaches the warning distance, the icon will glow red and orange, and the remote controller will emit long beeping sounds. When the aircraft reaches the obstacle braking distance, the icon will glow red, and the remote controller will emit short beep sounds. Both the obstacle braking distance and the warning distance can be set in DJI Pilot 2. Follow the prompted instructions in the app to set them.

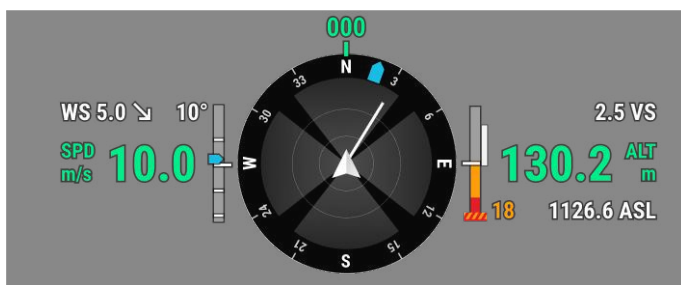

Horizontal Obstacle Sensing Information: The light areas are the obstacle sensing areas of the aircraft, while the dark areas are the blind spots. During flights, keep the aircraft speed vector line out of the obstacle-sensing blind spots.

- a. If the warning distance set in the app is from 16 m to 33 m, once an obstacle is detected, a green arc will appear in the direction of the obstacle; when the obstacle reaches the warning distance, it turns orange; when the obstacle approaches the obstacle breaking distance, it changes to a red frame.



- b. If the warning distance set in the app is less than 16 m, and the obstacle is within 16 m but has not reached the warning distance, the obstacle will be indicated by a green frame; when the obstacle is within 16 m and reaches the warning distance, it turns orange; when the obstacle approaches the obstacle breaking distance, it turns red.









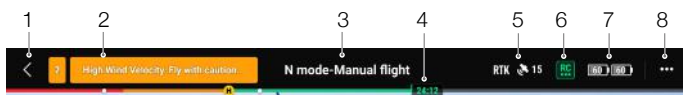

- c. When the obstacle sensing is disabled, OFF will be displayed; when obstacle sensing is turned on, the vision systems are not working but infrared sensing systems are available, TOF will be displayed; when obstacle sensing is turned on but not working, NA will be displayed.



## Top Bar



1. Back: Tap to return to the homepage of the DJI Pilot 2 app.
2. System Status Bar: indicates the aircraft flight status and displays various warning messages. If a new alert appears during flight, it will also be displayed here and continue flashing. Tap to view the information and stop the flashing.
3. Flight Status:
  - a. The flight statuses include: standby, preparing to take off, ready to go, manual flight, mission flight, pano in progress, ActiveTrack, returning to home, landing, forced landing, and vision positioning.

- b. When the aircraft is in vision positioning, standby, or manual flight status, the current flight mode will be displayed, including: N-mode, S-mode, A-mode, and T-mode.
  - c. Tap to enter Preflight Check view.
4. Intelligent Flight Battery Level Indicator: The battery level indicator bar provides a dynamic display of the remaining power of the current intelligent flight battery and the flying time. Each battery state is indicated by a different color. When the battery level is lower than the warning threshold, the battery icon on the right turns red, reminding the user to land the aircraft as soon as possible and replace the batteries.
5. GNSS Positioning Status: displays the number of GNSS satellites. When the aircraft RTK module is disabled, the RTK icon will turn gray; when it is enabled, the RTK icon will turn white. Tap the GNSS positioning status icon to view the status of the RTK mode and GNSS positioning.
6. Signal Strength: includes HD video link quality and remote controller link quality. Three green dots indicate strong signals; two yellow dots for medium signal strength; and one red dot for poor signal quality. If the signal is lost, the icon will display a disconnected status in red.
7. Intelligent Flight Battery Level: displays the remaining battery level of the aircraft. Tap to view battery level, voltage and temperature information.
8. Settings: Tap to expand the settings menu to set the parameters of each module.
- a.  Flight Control System Settings: include flight mode switch, Home Point, return to home altitude, maximum altitude, distance limit, sensor status, out-of-control action, coordinated turn, and GNSS.
  - b.  Sensing System Settings: include obstacle sensing switch, vision positioning switch, and precision landing switch.
  - c.  Remote Controller Settings: include stick mode, customizable button settings, and remote controller calibration and linking.
  - d.  Video Transmission Settings: include work frequency, channel mode, and video output type.
  - e.  Intelligent Flight Battery Settings: include battery information, smart return-to-home, low battery warning thresholds, and number of days required for self-discharge.
  - f.  Gimbal Settings: include gimbal pitch and pan settings, and gimbal auto calibration.
  - g.  RTK Settings: include the RTK positioning function, RTK service type, and their corresponding settings and status displays.
  - h.  General Settings: include map selection, track display, unit setting, and lights setting.

## AR Projection

DJI Pilot 2 App supports AR projection, including:

- a. Home Point: When the Home Point is beyond the current view, it will be displayed on the edge of the view. The aircraft can be turned towards the Home Point by following the arrow.
- b. PinPoints: A PinPoint appears bigger when near the aircraft and smaller when it is far. This allows users to judge the distance between the PinPoint and the aircraft from the size of the PinPoint. When a PinPoint selected is beyond the current view, it will be displayed on the edge of the view. The aircraft can be turned towards the PinPoint by following the arrow.
- c. Waypoints: In a mission flight, the two waypoints the aircraft is about to reach will be projected on FPV camera view or gimbal camera view. The next waypoint to be reached will appear as a solid triangle and a serial number; while the subsequent waypoint will appear as a dotted triangle and a serial number.
- d. ADS-B Manned Airplane: When a manned airplane is detected close by, it will be projected on FPV camera view and gimbal camera view. Ascend or descend the aircraft as soon as possible to avoid the manned airplane by following the prompted instructions.

## Gimbal Camera View

### Using Gimbal Camera View

Gimbal camera view will appear when you switch the main view to the gimbal camera. Below is an illustration using the zoom camera of the M30T as the main view.



1. Navigation Display: Refer to the Navigation Display section for details. Note that in gimbal camera view, the horizontal speed, wind speed, gimbal pitch angle and pitch scale, and the inclination of the gimbal relative to the ground are shown on the left side. When the gimbal is at a key angle such as -90°, 0°, or -45°, the number will be highlighted. The right side of Navigation Display shows the altitude, relative altitude, vertical obstacle sensing information, and vertical speed bar.
2. Camera Type: displays the camera type for the current main view.
3. Camera Parameters: displays the camera's current shoot/record parameters.
4. Auto Exposure Lock: Tap to lock the current exposure value.
5. Focus Mode: Tap to switch the focus mode, between MF (manual focus), AFC (continuous autofocus) and AFS (single autofocus).
6. Storage Mode: displays the remaining storage capacity of the aircraft's microSD card. Tap to switch the display mode, to show the remaining number of photos that can be taken in photo mode or the remaining recording time in video mode.
7. Switch to Auto/Manual Exposure: The zoom camera supports Auto and M modes. The EV can be set in Auto mode, and the ISO and shutter can be set in M mode.
8. Camera Settings: Tap to enter the camera setting menu. The camera setting menu may vary by camera type. Select a camera type to view its parameters.
9. Photo/Video Toggle: Tap to switch between photo and video modes, and select different shooting or recording modes.

- a. The photo modes include single, smart, timed, High-Res Grid shooting, panorama, etc.
  - b. Various resolutions can be selected in video recording mode. The zoom camera and wide-angle camera support resolutions of 3840×2160 and 1920×1080. For the thermal camera, the video recording resolution is 1280×1024 when infrared super-resolution is enabled, and 640×512 when it is disabled.
10. Shoot/Record Button: Tap to take a photo or start or stop recording.
  11. Playback: Tap to enter the album to view and download photos/videos stored in the aircraft's microSD card.
  12. Link Zoom (M30T only): Tap to link the lenses of the thermal camera and zoom camera to zoom. The user can view the linked zoom effect by enabling the SBS button in the thermal camera view.
  13. Press the R1 button on the remote controller, and the camera lens will zoom in.
  14. Press the R2 button on the remote controller, and the camera lens will zoom out.
  15. Press the R3 button on the remote controller to switch to FPV Camera View.
  16. FPV Camera View: Tap to switch to FPV camera view. The FPV camera view supports zooming in and out.
  17. Map View: Tap to switch to map view. The map view supports zooming in and out.
  18. PinPoint: Press the L3 button on the remote controller to add a PinPoint in the center of the screen. Press and hold on the L3 button to expand the PinPoint settings panel, which allows you to set the PinPoint color, view all target points, or enable the default display of target points in video transmission view. Refer to the PinPoint section for more details.
  19. Switch to Wide/Zoom Camera Lens: Press the L2 button on the remote controller to switch between the wide-angle camera lens and the zoom camera lens.
  20. Switch to Visible Light/Thermal Camera Lens (for M30T only): Press the L1 button on the remote controller to switch between the visible light camera lens (wide-angle camera or zoom camera) and the thermal camera lens.
  21. Gimbal Mode: displays the current gimbal status as follow mode. Tap to select an action such as gimbal recenter, gimbal pan recenter, gimbal tilt down, or gimbal down, or switch to gimbal free mode. Refer to the sections on the aircraft gimbal working modes for the detailed description of each mode.
  22. Smart Track: The aircraft's gimbal camera can track the target (person/vehicle/boat) when Smart Track is enabled. Refer to the Smart Track section for more details.
  23. RNG Laser Rangefinder: The straight-line distance between the aircraft and the target, as well as the height of the target can be measured using the RNG Laser Rangefinder. Refer to the RNG Laser Rangefinder section for more details.
  24. Look At: After selecting a PinPoint, the user can tap the Look At icon to rotate the gimbal, allowing the camera to look at the target.
  25. Status of Photo/Video Upload to Cloud: displays the status of a photo/video upload from DJI Pilot 2 to DJI FlightHub 2 or the connection status of a live stream; tap to view the details. If you are using the DJI FlightHub 2 cloud service, you can quickly configure its media file upload settings.





26. Mission Flight Control/Status: displays the progress of a mission flight in gimbal camera view. Tap the Pause/Resume button to pause/resume the task, and tap the panel to view the mission flight name and actions.



## Wide Camera View

This section mainly sets out the differences with zoom camera. Refer to the Gimbal Camera View section for more details.



Zoom Frame: After switching to a wide-angle camera as the main view, the zoom frame will display the field of view and camera zoom rate.

## Thermal Camera View

This section mainly sets out the differences with zoom camera. Refer to the Gimbal Camera View section for more details.



1. Palette/Isotherm: displays the highest and lowest temperature measurement values of the current view. Tap to choose between different infrared temperature measurement palettes, or enable the isotherm to set temperature measurement intervals. Note that if the measured area exceeds the maximum or minimum temperature measurement values of the current view, the setting will not take effect.
2. Gain Modes: High gain mode provides more accurate temperature measurements with a measurement range from -20 to 150 degrees, while low gain mode supports a wider temperature measurement range of 0 to 500 degrees. Note that the range is only a theoretical value, and even though the thermal camera can measure temperatures beyond the range, the value may deviate substantially.
3. Display Mode: The infrared screen is set as single infrared view by default. Tap to enable or disable side-by-side view. When enabled, both the footage captured by the infrared thermal camera and the zoom camera will be displayed side by side.
4. FFC Calibration: Tap to execute FFC calibration. FFC calibration is a function of the infrared thermal camera that optimizes image quality for easy observation of temperature changes.
5. Zoom (Thermal Camera): Tap to adjust the digital zoom of the infrared thermal camera with a maximum zoom capability of 20x. Tap and hold to zoom directly to 2x.

### Laser Rangefinder (RNG)

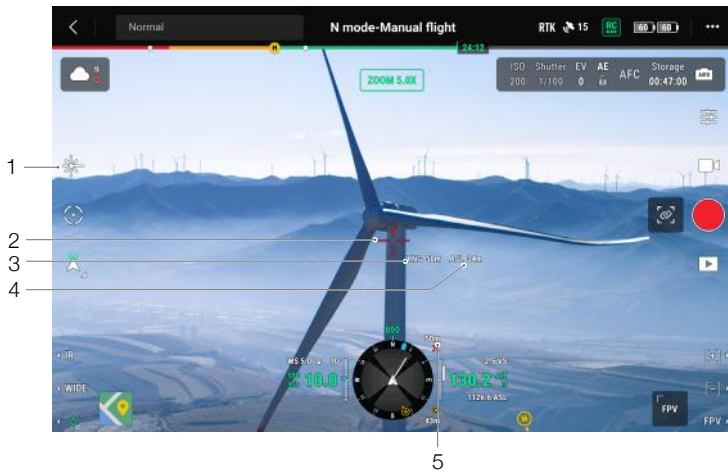

1. Tap to enable the RNG.
2. The cross hair in the center of the lens will turn red, which means the laser rangefinder is aiming at the target and measuring the altitude of the target and distance between the target and the aircraft. The latitude and the longitude of the target can be obtained after a PinPoint is created on the target.
3. The linear distance between the target and the aircraft.
4. The altitude between the target and the aircraft.
5. The horizontal distance between the target and the aircraft.

- ☀️ • RNG positioning is limited by factors such as the GNSS positioning accuracy and gimbal attitude accuracy. The GNSS position, horizontal distance, Navigation Display, and AR projection are provided for reference only.
- When the zoom camera is aiming, the cross hairs will be an upright cross, while with the wide-angle camera or thermal camera it will turn into an X.

## Smart Track

### Introduction

When operating the gimbal camera, the pilot can use Smart Track to identify, lock and track targets such as people, vehicles, boats, or other objects. After recognizing and locking the target, it will automatically rotate the gimbal to situate the target in the center of the screen, and adjust the camera focal length to an appropriate focus rate to track and view the target.



- ☀️ • When the tracked target is set to objects, the tracking effect will be limited.
- ⚠️ • Use Smart Track in an open environment to avoid blocking the target.
- When the aircraft is returning to the Home Point, landing or set to T-mode, Smart Track will be disabled. The device will exit Smart Track immediately in any of the above situations.

### Identifying and Locking a Target

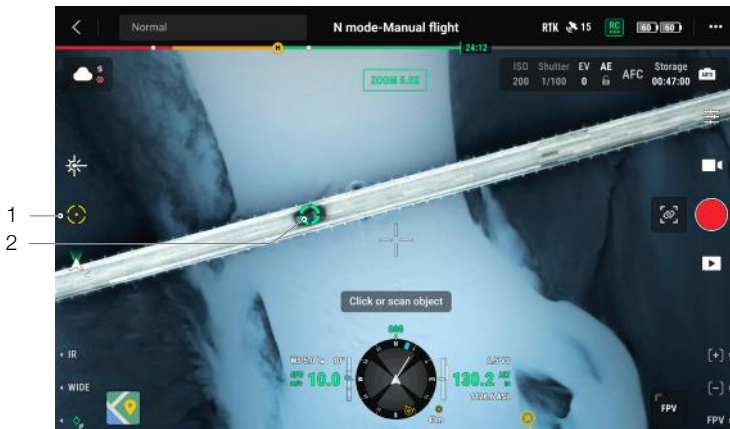
Smart Track can be enabled after entering zoom view in the app.



1. Tap to start or stop Smart Track.
2. The feature identifies a person, vehicle, or boat as the target. Alternatively, you can gesture on the screen to select another object as the target.

- 
    - When Smart Track is enabled, a tracking frame will appear and select the target, and the cross hairs in the center of the zoom lens will turn green, indicating that tracking is in progress. If no target is confirmed, the tracking frame will not appear and the app will display the message "Searching for targets ..." If the target is blocked or lost, the device will predict and search for the trajectory of the target until it is reacquired before resuming the tracking. Otherwise, the device will quit Smart Track.
- 
- 
    - If the user is selecting other types of targets by gesturing on the screen, any person, vehicle or boat that appears in the frame will be selected as the target and tracked.
    - An object cannot be selected using gestures if the features of the object are not clear.

### Tracking a Target

The gimbal mode will default to follow mode, and the camera will default to AFC mode when Smart Track is enabled.

In gimbal follow mode, the orientation of the aircraft is always consistent with that of the gimbal, both aiming at the target. The attitude of the gimbal will be adjusted automatically to situate the target in the center, while the camera will adjust its zoom to re-size the target. The user can fine-tune the size of the target in the field of view using the right dial of the remote controller.

**Target Prediction:** If a target is lost, the device will predict the motion trajectory and the gimbal will rotate automatically to search for the target.

**Target Search:** If the target is lost, the device will automatically search for its based on its predicted position. The user can also manually control the gimbal rotation and camera zoom to find the target.

**Focus Tracking:** The camera focus will be adjusted according to the distance of the target object.

In gimbal follow mode, "Smart Track" will be displayed on the top bar during tracking. The control mode of the aircraft is slightly different from its normal flight mode. Make sure you are familiar with the following controls and fly with caution.

Operation on Remote Controller	Action Performed	Reminders
Pressing and holding the Pause button	Exits Smart Track.	/
Yaw stick	Adjusts yaw movement of gimbal	The adjustable range is limited during tracking.
Pitch stick	Flies the aircraft toward or away from the target horizontally. The maximum flight speed is less than 17 m/s. Continue operating the stick to keep tracking the target.	When it is close to the target horizontally, the aircraft's speed in the direction close to the target will be limited. The aircraft cannot approach the target in the following condition: <ol style="list-style-type: none"> <li>a. The aircraft is less than 5 meters from the target.</li> <li>b. The target is under the aircraft that the gimbal tilt needs to be greater than 80°.</li> </ol>

Roll stick	The aircraft circles the target horizontally. The maximum flight speed is less than 17 m/s.	When it is close to the target horizontally, the aircraft's orbiting speed will be limited.
Throttle stick	Controls the aircraft altitude	/
Left dial	Adjusts the gimbal tilt	The adjustable range is limited during tracking.
Right dial	Adjusts the camera zoom	The adjustable range is limited during tracking.
Switching the flight mode	Exit Smart Track.	/

- 
-  • To ensure optimal shooting of moving targets, taking photos during target tracking will not lock the gimbal. Motion blur may occur due to a static background.

- 
-  Poor recognition or tracking effect may occur in the below scenes:
- a. Recognition may decline at night.
  - b. The tracking effect may decline when the payload is working at high magnification.
  - c. The tracking effect may decline in environments with poor visibility such as in a rain, fog, or haze.
  - d. The tracked object/target may change in scenes with heavy traffic, crowds, or large clusters of similar objects.
-

Map View

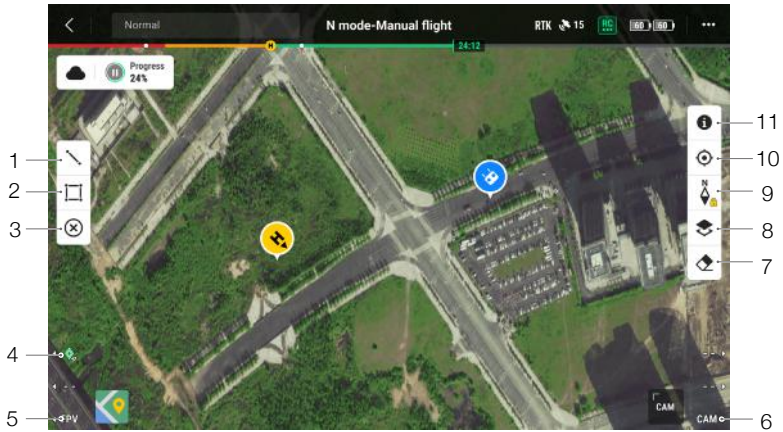

1. Tap to draw lines on the map.
2. Tap to draw an area on the map.
3. Tap to clear all points, lines, and annotations on the current view. If the user is logged in on DJI FlightHub 2, performing this action will not clear the annotations distributed by DJI FlightHub 2.
4. PinPoint: Press the L1 button on the remote controller to add a PinPoint in the center of the view. Press and hold on the L1 button to expand the PinPoint settings panel, which allows users to change the PinPoint color, view all target points, or set the default display of the target point in video transmission view.
5. Switch to FPV Camera View: Press the L3 button on the remote controller to switch to FPV camera view.
6. Switch to Gimbal Camera View: Press the R3 button on the remote controller to switch to gimbal camera view.
7. Tap to clear the flight track of the aircraft.
8. Map Layer Selection: Tap to select a satellite or street map (standard mode) according to operation requirements.
9. Map Lock: If enabled, the map cannot be rotated; if disabled, the map can rotate freely.
10. Recenter Button: Tap to quickly center the remote controller in the view.
11. GEO Zone Layer Management: Tap to view all GEO Zone layer information and enable or disable the GEO Zone layer.

## Annotation Management and Synchronization

### PinPoint

#### Introduction to PinPoint

PinPoint can be used to set the location point of a target in gimbal camera view or map view, for quick observation and information synchronization.

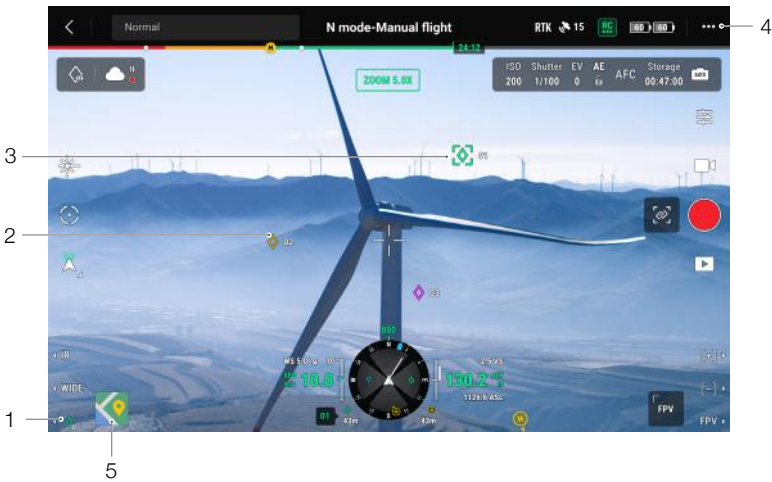

1. Steps to Create a PinPoint: Adjust the attitude of the aircraft and the gimbal to move the target to the center of the current view. Press the L3 button of the remote controller to pin the target at the center. The PinPoint can record the latitude, longitude and altitude of the target.
2. AR projection will be created for the target in gimbal camera view or FPV camera view. It will become larger or smaller according to the distance between the aircraft and the PinPoint (big when near, small when far).
3. Selected PinPoint:
  - a. A small frame will appear around the PinPoint indicating it is selected.
  - b. The lower left corner of Navigation Display shows the horizontal distance from the target to the aircraft and the name of the point. The orientation of the point relative to the aircraft is shown within Navigation Display.
  - c. If the selected PinPoint is outside the video transmission view, the PinPoint icon will stay on the edge indicating its orientation relative to the center of the view.
  - d. After selecting a PinPoint, the user can edit the name, color, latitude, longitude, and altitude of the target point, or drag the PinPoint on the map.
4. Tap **⋮** and tap **🗑️** to change the custom remote controller settings to PinPoint, delete the selected



PinPoint, or select the previous or next PinPoint. Users can quickly generate and select PinPoints by using the buttons.

5. Tap to switch to map view:
  - a. The PinPoint and its name will be displayed on the map accordingly.
  - b. In map view, you can also set a PinPoint by tapping the target. The point is at the cross hairs in the center of the map, and the altitude is the current flight altitude of the aircraft.
  - c. Tap to select a PinPoint on the map to view the creator of the point, the distance between the target point and the aircraft, the altitude, latitude and longitude of the target point, or set the PinPoint as the Home Point, or edit or delete the PinPoint.

---

💡 • PinPoint positioning is limited by factors such as the GNSS positioning accuracy and gimbal attitude accuracy. The latitude and longitude, horizontal distance, Navigation Display, and AR projection are provided for reference only.

---

### Editing PinPoints

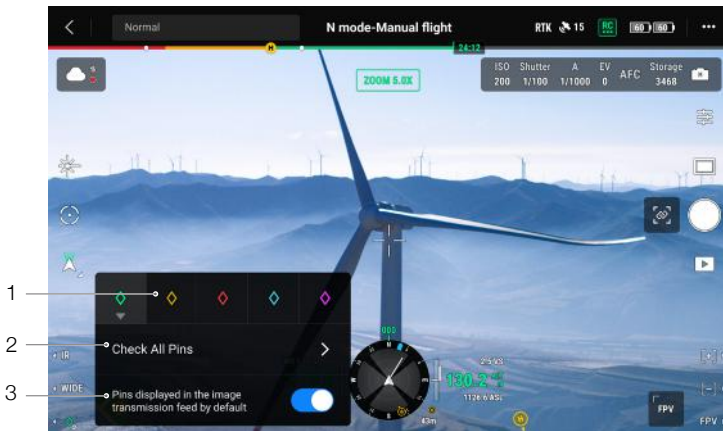

1. Press and hold the L3 button on the remote controller to bring up the settings panel of the PinPoint. There are five color options for the PinPoint, and it is recommended to set a color for each type of target as required by the operation scenario.
2. Tap to expand the PinPoint list to view all the target points.
3. Set whether to display the newly created PinPoint in video transmission view.

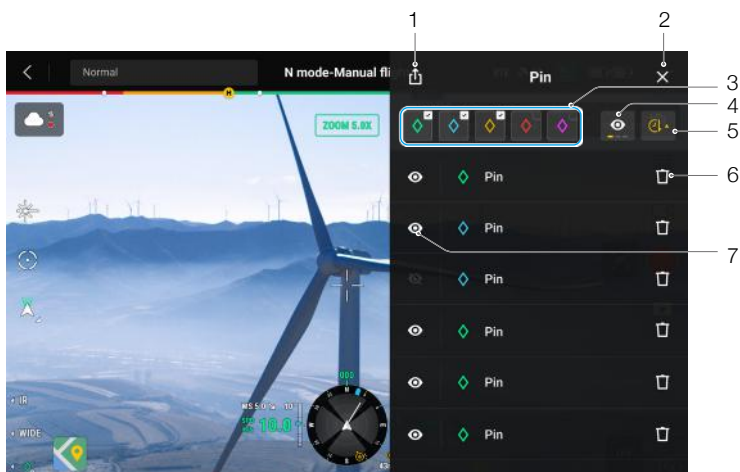

1. Tap to export all PinPoints to the local folder of the remote controller.
2. Tap to close the current panel.
3. Filter the PinPoints by color. After a color is selected, it is displaying PinPoints of this color.
4. Filter the PinPoints by their visibility in video transmission view. The PinPoints can be filtered by any of these three criteria: show all PinPoints on this list; only show PinPoints that are visible in video transmission view on this list; only show PinPoints that are not visible in video transmission view on this list.
5. Tap to sort PinPoints in forward or reverse chronological order, or in alphabetical order by their names.
6. Tap to delete the PinPoint.
7. Tap to enable or disable AR projection display for the PinPoint in video transmission view.

## Line and Area Annotation Management

Users can draw lines and areas on the map for synchronizing key information of roads and land.



1. Tap to display the Edit Line view.
2. Tap to display the Edit Area view.
3. All the point, line and area information can be viewed on the map. Tap this icon to delete the information.

## Annotation Sharing

The location of the target point identified by PinPoint can be synchronized with camera view, Navigation Display, map view, and DJI FlightHub 2 for sharing of location information. It can be displayed on both video transmission view and map view.



In Advanced Dual Operator mode, all point, line and area annotations can be synchronized with another remote controller.

When connected to DJI Flighthub 2, the DJI Pilot 2 app and the point, line and area annotations of DJI Flighthub 2 can be synchronized with each other. They can be viewed on the remote controller and other devices logged into DJI Flighthub 2 for real-time sharing of locations and annotations.

## Mission Flight

Tap on the homepage of DJI Pilot 2 to enter the mission library. The user can view created mission flight routes, or newly created Waypoint, Mapping, Oblique, or Linear Flight missions. The above four types of missions are generated by the app; Waypoint flights can also be created through Live Mission Recording.

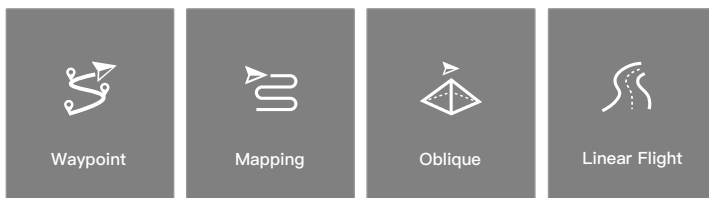

### Mission Flight Introduction

The mission flight function is illustrated below with Waypoint flights as an example.

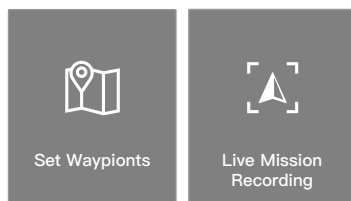

Waypoint flights can be planned in of two ways: Set Waypoints and Live Mission Recording. Use Set Waypoints to create a route by adding editable waypoints on the map. Use Live Mission Recording to create a route by adding waypoints and editing the target in photos captured along the route.

## Mission Flight - Setting Waypoints

Tap Create a Route, Waypoint flight, and then Set Waypoints to create a new flight route. Tap on the map to add waypoints, then configure route and waypoint settings.

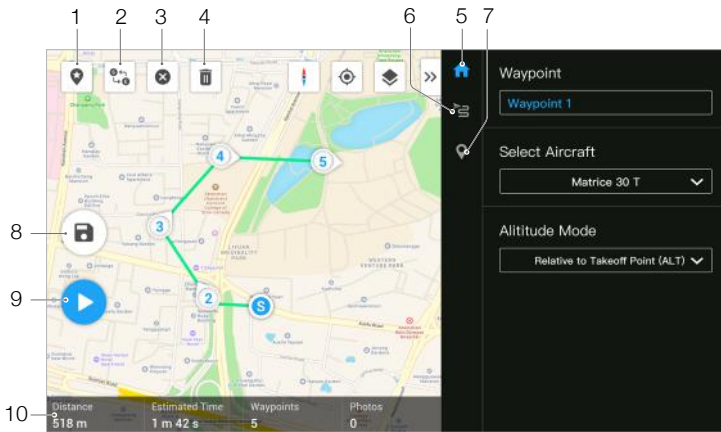

1. Point of Interest (POI): Tap to enable the POI function and a POI will be displayed on the map. Drag to adjust its position. After a POI is added, the aircraft yaw can be set as facing the POI so that the aircraft nose points at the POI point during the mission. Tap this icon again to disable the POI function.
2. Reverse Path: Tap to swap the start and end points to reverse the flight path. S refers to the start point.
3. Clear Waypoints: Tap to clear all the added waypoints.
4. Delete Selected Waypoint: Tap to delete the selected waypoint.
5. Parameters List: Edit the route name, advance flight route settings and altitude mode, and set the aircraft type as M30 or M30T.
6. Route Settings: The settings are applied to the entire route, including safe takeoff altitude, ascend to start point, aircraft speed, aircraft altitude, aircraft yaw, gimbal control, waypoint type, and completion action. These parameters will take effect for all waypoints in the route. On how to set the relevant parameters for the waypoints individually, please refer to the next description.
7. Set Individual Waypoints: Select a waypoint and set its parameters. Tap "<" or ">" to switch to the previous or next waypoint. The settings are applied to the selected waypoint, including aircraft speed, aircraft altitude, aircraft yaw mode, waypoint type, aircraft rotation, gimbal tilt, waypoint actions, longitude and latitude.
8. Save: Tap to save the current settings.
9. Perform: Tap the button and then check the settings and status of the aircraft in the pop-up checklist. Tap the Start Flight button to perform the mission.
10. Flight Route Information: displays the flight length, estimated flight time, waypoint quantity, photo quantity.

### Mission Flight - Live Mission Recording

Tap Create a Route, Waypoint Flight, and Live Mission Recording to record information on the photos captured or aircraft position for the waypoint.

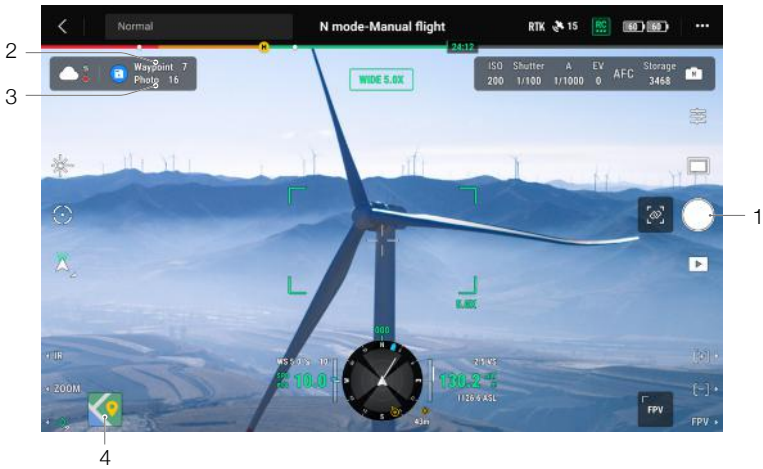

1. Control the gimbal, adjust the camera zoom and aim at the target, and tap to capture a photo directly or press the C1 on the remote controller to set a waypoint. The waypoint and photo quantity will increase accordingly.
2. The number of planned waypoints.
3. The number of planned photos.
4. Tap to switch to map view for editing or viewing.

### In-Flight Editing

Enter the mission library, select a created flight route for editing or viewing.



1. Tap to perform the current mission.
2. Tap to enter the In-Flight Editing view. The edits will be merged into the original route after they are saved.
3. Tap to enter the Set Waypoints page.



## Health Management System (HMS)

The HMS system includes the DJI Maintenance Program, DJI Care Enterprise, Firmware Update, Manage Logs, Error Records, and Error Diagnosis.

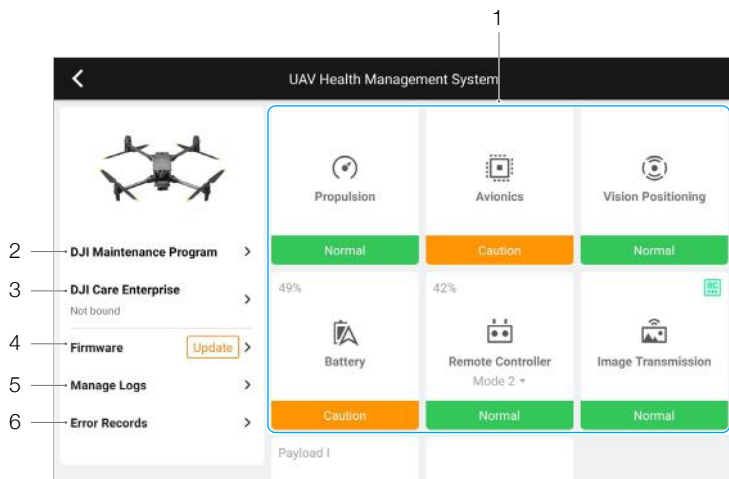

1. Error Diagnosis: for checking the current health status of each module of the aircraft. Users can solve errors by following the relevant prompted instructions.

Color	Status
Green	Normal
Orange	Caution
Red	Warning

2. DJI Maintenance Program: Users can view historical flight data and refer to the maintenance manual to determine if maintenance is required.
3. DJI Care: Relevant information can be viewed if the device is bound to DJI Care.
4. Firmware Update: Tap to enter the Firmware Update view.
5. Manage Logs: displays the remote controller and aircraft log data of recent sorties. The user can assist by extracting the relevant logs to local storage or upload them directly to the DJI Support cloud, to facilitate troubleshooting by DJI Support.
6. Error Records: records of aircraft historical for determining if any serious problem has occurred during aircraft operation. This helps users evaluate the stability of the aircraft and assists DJI Support in conducting aftersales analysis.

- ⚙️ • Error Records are available for the batteries and battery station (the battery station must be connected to the remote controller via the USB-C cable).
- Manage Logs is available for the batteries and battery station (the battery station must be connected to the remote controller via the USB-C cable).

### Intelligent Battery Station Status and Log Management

To check the battery station status in HMS in DJI Pilot 2, connect the battery station to the remote controller via a UBS-C cable. The user can also update the battery station and battery firmware and export the battery station and battery logs in batches.

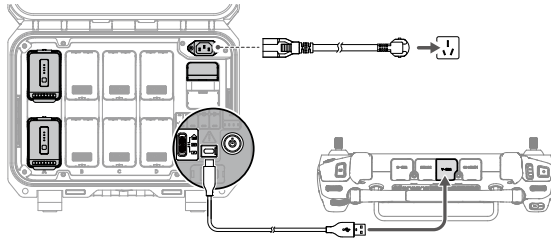

#### Checking the Battery Station Status

Run DJI Pilot 2, tap HMS to check the status of the battery station and batteries. If a warning appears, tap it for more detailed information and follow the prompted instructions to resolve the issue.

#### Exporting Battery Station Logs

1. Run DJI Pilot 2, tap HMS, then Manage Logs, and select Battery Station Logs.
2. Check the logs of the battery station and all batteries.
3. Tap Upload Log and follow the prompted instructions to upload the selected logs.

## DJI FlightHub 2

Paired with the DJI FlightHub 2 cloud platform, the M30 series offers integrated air and ground handling with efficient operation management. The combined features of the two products makes a wide range of real-time operations possible, including cloud mapping, point, line, and area annotation, flight information syncing, live viewing, media file upload or download, mutual access to statuses of multiple aircraft, mission flight syncing, and real-time control from mobile devices.

For more details, refer to the DJI FlightHub 2 User Guide which is available to download from the official DJI website <https://www.dji.com/flighthub-2/downloads>.

# Firmware Update

---

This chapter introduces the methods of updating the firmware of the device.

# Firmware Update

Use DJI Pilot 2 or DJI Assistant 2 (Enterprise Series) to update the remote controller, aircraft and other connected DJI devices.

## Using DJI Pilot 2

### Aircraft and Remote Controller

1. Power on the aircraft and remote controller. Ensure the aircraft is properly linked to the remote controller, their battery levels are higher than 25%, and the remote controller is connected to the internet.
2. Run DJI Pilot 2. A prompt will appear on the homepage if new firmware is available. Tap to enter the Firmware Update view.
3. Tap Update All and DJI Pilot 2 will download the firmware and update the aircraft and remote controller.
4. The aircraft and remote controller will automatically restart after the firmware update is completed.



- Make sure the remote controller is charged over 25% before updating. The update takes approximately 15 minutes (depending on network strength). Make sure the remote controller is connected to the internet during the whole update process.
- The TB30 intelligent flight batteries installed on the aircraft will be updated to the latest firmware version.

### Battery Station and TB30 Batteries

Use the DJI Pilot 2 app to update the firmware of the battery station as well as up to eight TB30 flight batteries at the same time.

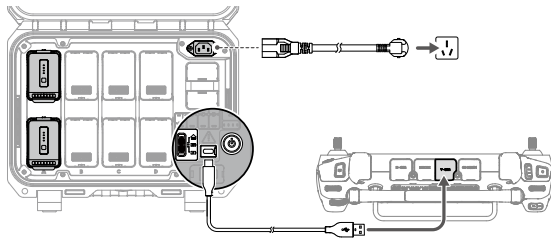

1. Insert the TB30 batteries into the battery port and power on the battery station.
2. Connect the battery station USB-C maintenance port to the remote controller USB-A port using a USB-C cable.
3. Power on the remote controller and make sure it is connected to the internet.
4. Run DJI Pilot 2. If a version update is available, the homepage will prompt that the battery station firmware update is required. Tap to enter the battery station update page.
5. Tap the Update All button to begin the update, which takes approximately 10 minutes. The update is completed when the update success prompt appears.

- ⚠ • During a firmware update, DO NOT insert or remove the batteries to avoid battery update failure.
  - During a firmware update, DO NOT unplug the USB-C cable to avoid firmware update failure.
- 

## Offline Update

An offline firmware package can be downloaded from the DJI official website to an external storage device such as a microSD card or U disk. Run DJI Pilot 2, tap HMS, and then Firmware Update. Tap Offline Update to select the firmware package of the remote controller, aircraft, or battery station from the external storage device and tap Update All to update.

## Using DJI Assistant 2 (Enterprise Series)

DJI Assistant 2 (Enterprise Series) supports the updating of the remote controller and aircraft but not the BS30 battery station. Please use the DJI Pilot 2 app to update the battery station.

## Aircraft and Remote Controller

1. Connect the remote controller or aircraft to the PC one by one, as the assistant software does not support the updating of multiple DJI devices at the same time.
2. Make sure the PC is connected to the internet and the DJI device is powered on with a battery level higher than 25%.
3. Run the assistant software, log in with your DJI account and enter the main interface.
4. Tap the firmware update button on the left side of the main interface.
5. Select the firmware version and tap to update. The assistant software will download and update the firmware automatically.
6. When the "Update successful" prompt appears, the device update is completed, and the DJI device will restart automatically.

- ⚠ • The battery firmware is included in the aircraft firmware. Be sure to update the firmware of all batteries.
  - For the firmware update process, the battery levels of the aircraft and remote controller must be higher than 25%.
  - Make sure all DJI devices are connected properly to the PC during an update.
  - During the update process, it is normal for the gimbal to go limp, the aircraft status indicators to blink, and the aircraft to reboot. Wait patiently for the update to complete.
  - Make sure to keep the aircraft away from people and animals during a firmware update, system calibration or parameter configuration.
  - For safety, make sure you are using the latest firmware version.
  - After the firmware update is completed, the remote controller and the aircraft may become disconnected. Re-link them if necessary.
-

# Appendix

---

This chapter provides the specifications.

# Appendix

## Introduction to the Carrying Case

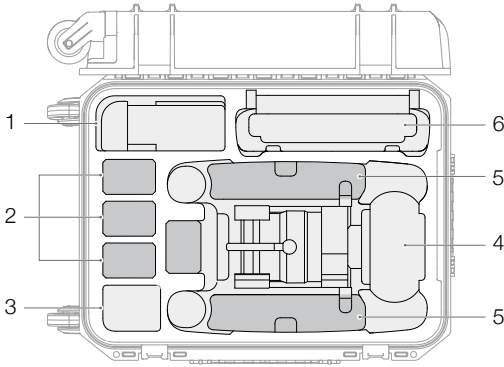

1. Cables and Screws
2. TB30 Intelligent Flight Battery
3. Reserved
4. Aircraft body
5. Propellers
6. Remote controller and manuals

## Specifications

### Aircraft

#### General

Dimensions (unfolded, excl. propellers)	470×585×215 mm (L×W×H)
Dimensions (folded)	365×215×195 mm (L×W×H)
Diagonal Wheelbase	668 mm
Weight (incl. two batteries)	3770 ± 10 g
Max Takeoff Weight	3998 g
Operating Frequency <sup>[1]</sup>	2.4000-2.4835 GHz, 5.725-5.850 GHz
Transmitter Power (EIRP)	2.4 GHz: <33 dBm (FCC); <20 dBm (CE/SRRC/MIC) 5.8 GHz: <33 dBm (FCC/SRRC); <14 dBm (CE)
Hovering Accuracy (windless or breezy)	Vertical: ±0.1 m (Vision System enabled); ±0.5 m (N-mode with GPS); ±0.1 m (RTK) Horizontal: ±0.3 m (Vision System enabled); ±1.5 m (N-mode with GPS); ±0.1 m (RTK)
RTK Positioning Accuracy (fixed RTK enabled)	1 cm+1 ppm (horizontal) 1.5 cm+1 ppm (vertical)
Max Angular Velocity	Pitch: 150°/s; Yaw: 100°/s
Max Tilt Angle	35° (N-mode and Forward Vision System enabled: 25°)
Max Ascent/Descent Speed	6 m/s; 5 m/s
Max Tilt Descent Speed	7 m/s
Max Horizontal Speed	23 m/s
Max Service Ceiling Above Sea Level (without other payload)	5,000 m (with 1671 propellers) 7,000 m (with 1676 propellers)
Max Wind Resistance	15 m/s 12 m/s during taking off and landing
Max Hover Time <sup>[2]</sup>	36 min
Max Flight Time <sup>[2]</sup>	41 min
Motor Model	3511
Propeller Model	1671 1676 High Altitude (not included)
Ingress Protection Rating <sup>[3]</sup>	IP55
GNSS	GPS+Galileo+BeiDou+GLONASS (GLONASS is supported only when RTK module is enabled)
Operating Temperature	-20° to 50° C (-4° to 122° F)

#### Gimbal

Angular Vibration Range	±0.01°
Controllable Range	Pan: ±90°, Tilt: -120° to +45°
Mechanical Range	Pan: ±105°, Tilt: -135° to +60°, Roll: ±45°



Zoom Camera	
Sensor	1/2" CMOS, Effective pixels: 48M
Lens	Focal length: 21-75 mm (equivalent: 113-405 mm) Aperture: f/2.8-f/4.2 Focus: 5 m to ∞
Exposure Compensation	±3 ev (using 1/3 ev as step length)
Electronic Shutter Speed	Auto Mode: Photo: 1/8000-1/2 s Video: 1/8000-1/30 s M Mode: Photo: 1/8000-8 s Video: 1/8000 -1/30 s
ISO Range	100-25600
Max. Video Resolution	3840×2160
Max Photo Size	8000×6000
Wide Camera	
Sensor	1/2" CMOS, Effective pixels: 12M
Lens	DFOV: 84° Focal length: 4.5 mm (equivalent: 24 mm) Aperture: f/2.8 Focus: 1 m to ∞
Exposure Compensation	±3 ev (using 1/3 ev as step length)
Electronic Shutter Speed	Auto Mode: Photo: 1/8000-1/2 s Video: 1/8000-1/30 s M Mode: Photo: 1/8000-8 s Video: 1/8000-1/30 s
ISO Range	100-25600
Max. Video Resolution	3840×2160
Photo Size	4000×3000
Thermal Camera	
Thermal Imager	Uncooled VOx Microbolometer
Lens	DFOV: 61° Focal length: 9.1 mm (equivalent: 40 mm) Aperture: f/1.0 Focus: 5 m to ∞
Infrared Temperature Measurement Accuracy <sup>[4]</sup>	±2°C or ±2% (using the larger value)
Video Resolution	Infrared Image Super-resolution Mode: 1280×1024 Normal Mode: 640×512
Photo Size	Infrared Image Super-resolution Mode: 1280×1024 Normal Mode: 640×512
Pixel Pitch	12 μm
Temperature Measurement Method	Spot Meter, Area Measurement

Temperature Measurement Range	High Gain Mode: -20° to 150° C (-4° to 302° F) Low Gain Mode: 0° to 500° C (32° to 932° F)
Temperature Alert	Supported
Palette	White Hot/Black Hot/Tint/Iron Red/Hot Iron/Arctic/Medical/ Fulgurite/Rainbow 1/Rainbow 2
<b>FPV Camera</b>	
Resolution	1920×1080
DFOV	161°
Frame Rate	30 fps
<b>Laser Module</b>	
Wavelength	905 nm
Max Laser Power	3.5 mW
Single Pulse Width	6 ns
Measurement Accuracy	± (0.2 m + D×0.15%) D is the distance to a vertical surface
Measuring Range	3-1,200 m (0.5×12 m vertical surface with 20% reflectivity)
<b>Vision Systems</b>	
Obstacle Sensing Range	Forward: 0.6-38 m Upward/Downward/Backward/Sideward: 0.5-33 m
FOV	65° (H), 50° (V)
Operating Environment	Surfaces with clear patterns and adequate lighting (> 15 lux)
<b>Infrared Sensing Systems</b>	
Obstacle Sensing Range	0.1-10 m
FOV	30°
Operating Environment	Large, diffuse, and reflective obstacles (reflectivity >10%)
<b>TB30 Intelligent Flight Battery</b>	
Capacity	5880 mAh
Voltage	26.1 V
Battery Type	Li-ion 6S
Energy	131.6 Wh
Net Weight	Approx. 685 g
Operating Temperature	-20° to 50° C (-4° to 122° F)
Storage Temperature	20° to 30° C (68° to 86° F)
Charging Temperature	-20° to 40° C (-4° to 104° F) (When the temperature is lower than 10° C (50° F), the self-heating function will be automatically enabled. Charging in a low temperature may shorten the lifetime of the battery)
Chemical System	LiNiMnCoO2
<b>Auxiliary Lights</b>	
Effective Illumination Distance	5 m

Illumination Type	60 Hz, solid glow
-------------------	-------------------

## Remote Controller

General	
Screen	7.02 inch LCD touchscreen, with a resolution of 1920×1200 pixels, and high brightness of 1200 cd/m <sup>2</sup>
Dimensions (antennas folded)	268×162.7×94.3 mm (L×W×H)
Weight	Approx. 1.25 kg (excl. WB37 battery) Approx. 1.42 kg (incl. WB37 battery)
Internal Battery	Type: Li-ion (6500 mAh @ 7.2 V) Charge Type: Supports battery station or USB-C charger maximum rated power 65W (max voltage of 20V) Charge Time: 2 hours Chemical System: LiNiCoAlO <sub>2</sub>
External Battery (WB37 Intelligent Battery)	Capacity: 4920 mAh Voltage: 7.6 V Battery Type: Li-ion Energy: 37.39 Wh Chemical System: LiCoO <sub>2</sub>
Operating Time <sup>[6]</sup>	Internal Battery: Approx. 3 hours 18 min Internal Battery + External Battery: Approx. 6 hours
Ingress Protection Rating <sup>[3]</sup>	IP54
GNSS	GPS+Galileo+BeiDou
Operating Temperature	-20° to 50° C (-4° to 122° F)
O3 Enterprise	
Operating Frequency <sup>[1]</sup>	2.4000-2.4835 GHz, 5.725-5.850 GHz
Max Transmission Distance (unobstructed, free of interference)	15 km (FCC); 8 km (CE/SRRC/MIC)
Max Transmission Distance (with interference)	Strong Interference (urban landscape, limited line of sight, many competing signals): 1.5-3 km (FCC/CE/SRRC/MIC) Medium Interference (suburban landscape, open line of sight, some competing signals): 3-9 km (FCC); 3-6 km (CE/SRRC/MIC) Weak Interference (open landscape abundant line of sight, few competing signals): 9-15 km (FCC); 6-8 km (CE/SRRC/MIC)
Transmitter Power (EIRP)	2.4 GHz: <33 dBm (FCC); <20 dBm (CE/SRRC/MIC) 5.8 GHz: <33 dBm (FCC); <14 dBm (CE); <23 dBm (SRRC)
Wi-Fi	
Protocol	Wi-Fi 6
Operating Frequency <sup>[1]</sup>	2.4000-2.4835 GHz; 5.150-5.250 GHz; 5.725-5.850 GHz
Transmitter Power (EIRP)	2.4 GHz: <26 dBm (FCC); <20 dBm (CE/SRRC/MIC) 5.1 GHz: <26 dBm (FCC); <23 dBm (CE/SRRC/MIC) 5.8 GHz: <26 dBm (FCC/SRRC); <14 dBm (CE)

Bluetooth	
Protocol	Bluetooth 5.1
Operating Frequency	2.4000-2.4835 GHz
Transmitter Power (EIRP)	<10 dBm

### Intelligent Battery Station

Model	CSX320-550
Dimensions	353x267x148 mm
Net Weight	3.95 kg
Compatible Battery Type	TB30 Intelligent Flight Battery WB37 Intelligent Battery
Input	100-240 VAC, 50/60 Hz
Output	TB30 Battery Port: 26.1 V, 8.9 A (supported up to two outputs simultaneously) WB37 Battery Port: 8.7 V, 6 A
Output Power	525 W
USB-C Port	Max. output power of 65 W
USB-A Port	Max. output power of 10 W (5 V, 2 A)
Power Consumption (when not charging battery)	< 8 W
Output Power (when warming up battery)	Approx. 30 W
Operating Temperature	-20° to 40° C (-4° to 104° F)
Ingress Protection Rating	IP55 (with the cover closed properly)
Charging Time <sup>[6]</sup>	Approx. 30 min (charging two TB30 batteries from 20% to 90%) Approx. 50 min (charging two TB30 batteries from 0% to 100%)
Protection Features	Anti-Backflow Protection Short Circuit Protection Over Voltage Protection Over Current Protection Temperature Protection

[1] 5.8 and 5.1GHz frequencies are prohibited in some countries. In some countries, the 5.1GHz frequency is only allowed for use indoors.

[2] The maximum flight time and the hover time were tested in a lab environment and is for reference only.

[3] This protection rating is not permanent and may reduce over time after long-term use.

[4] The infrared temperature measurement accuracy was tested in a lab environment and is for reference only.

[5] The maximum operating time was tested in a lab environment and is for reference only.

[6] The charging time was tested in a lab environment at room temperature. The value provided should be used for reference only.



CONTACT  
DJI SUPPORT

---

This content is subject to change without notice.

Download the latest version from



<https://www.dji.com/matrice-30/downloads>

If you have any questions about this document, please contact DJI by sending a message to **DocSupport@dji.com**.