

dji MIC MINI

User Manual

v1.0 2024.11

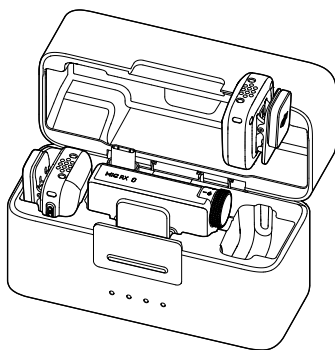



This document is copyrighted by DJI with all rights reserved. Unless otherwise authorized by DJI, you are not eligible to use or allow others to use the document or any part of the document by reproducing, transferring, or selling the document. Users should only refer to this document and the content thereof as instructions to operate DJI products. The document should not be used for other purposes.

Searching for Keywords

Search for keywords such as Battery or Install to find a topic. If you are using Adobe Acrobat Reader to read this document, press Ctrl+F on Windows or Command+F on Mac to begin a search.

Navigating to a Topic

View a complete list of topics in the table of contents. Click on a topic to navigate to that section.

Printing this Document

This document supports high resolution printing.

Using this Manual

Legend

 Important

 Hints and Tips

 Reference

Read Before Use

DJI™ provides you with tutorial videos and the following documents:

1. *Safety Guidelines*
2. *Quick Start Guide*
3. *User Manual*

It is recommended to watch all the tutorial videos and read the *Safety Guidelines* before using for the first time. Make sure to review the *Quick Start Guide* before using for the first time and refer to this *User Manual* for more information.

Contents



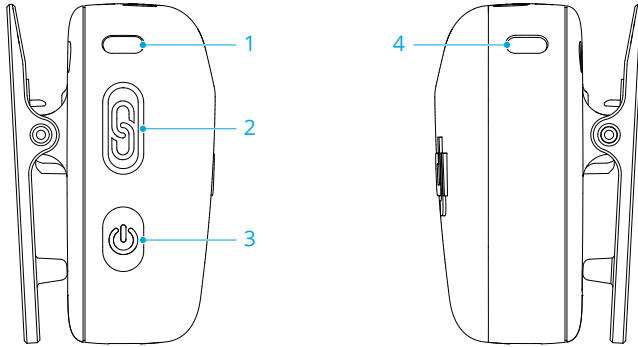

Using this Manual	3
Legend	3
Read Before Use	3
1 Product Profile	5
1.1 Transmitter	5
1.2 Receiver	6
1.3 Charging Case	8
2 Using the Product	10
2.1 Charging	10
Charging with the Charging Case	10
Charging with the Charging Dock	10
2.2 Installing the Windscreen	11
2.3 Wearing the Transmitter	11
2.4 Linking the Transmitter and Receiver	12
Linking via the Charging Case	12
Linking Manually	12
2.5 Using with a Phone	12
2.6 Using with a Camera	13
2.7 Using with a Computer	14
2.8 Transmitter Directly Connected to Filming Devices	14
Connecting to a Phone	14
Connecting to DJI Filming Devices	15
3 Firmware Update and Parameter Adjustment	16
3.1 Connecting to the DJI Mimo App	16
Connecting via the Adapter	16
Connecting via Bluetooth	16
3.2 Updating Firmware	17
3.3 Adjusting Parameters	17
4 Appendix	18
4.1 Specifications	18
4.2 Aftersales Information	18

1 Product Profile

1.1 Transmitter



1. System Status LED

Battery Level		
 —	Solid red	0-10%
 —	Solid green/blue*	> 10%
Link Status with the Receiver		
 —	Solid green	Linked with the receiver
 ·····	Blinks green slowly	Not linked with the receiver
 ·····	Blinks blue and green alternately	Linking
Bluetooth Link Status		
 —	Solid blue	Linked with a Bluetooth device
 ·····	Blinks blue slowly	No Bluetooth device linked
 ·····	Blinks blue and green alternately	Linking
Battery Level During Charging*		
 ·····	Blinks green/blue slowly	0-25%
 × 2 ·····	Blinks green/blue twice	26-50%
 × 3 ·····	Blinks green/blue three times	51-75%
 × 4 ·····	Blinks green/blue four times	76-100%
	Off	Fully charged
Firmware Update		

 —	Solid yellow	Firmware updating
---	--------------	-------------------

* The color of the light depends on the working mode. Take the green light as an example.

2. **Linking Button**

Press and hold for two seconds to start linking. After connecting the microphone to DJI filming device, press to start or stop recording videos.

3. **Power Button**

Press and hold for two seconds to power on or off. Press to enable or disable noise cancelling.

4. **Noise Cancellation LED**

Solid yellow: Noise cancelling enabled

LED off: Noise cancelling disabled

1.2 Receiver

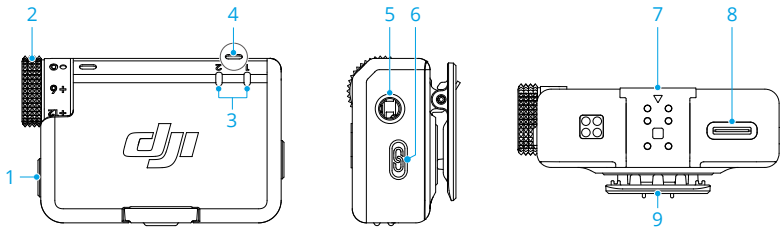



1. **Power Button**

Press and hold for two seconds to power on or off.

2. **Dial**













Rotate to adjust the gain of the receiver.

3. **Transmitter Status LED**

Battery Level		
 —	Solid red	0-10%
 —	Solid green	> 10%
Status		

	Off	Not linked with the receiver
	Blinks green quickly	Linking
	Solid yellow	Noise cancelling enabled

4. Receiver Status LED

Battery Level		
	Solid red	0-10%
Channel		
	Solid green	Mono/Safety Track
	Solid cyan	Stereo
	Blinks green/cyan slowly*	No audio recording device linked
Bluetooth Link Status		
	Solid blue	Linked with a Bluetooth device
	Blinks blue slowly	No Bluetooth device linked
Battery Level During Charging**		
	Blinks green/blue slowly	0-25%
	Blinks green/blue twice	26-50%
	Blinks green/blue three times	51-75%
	Blinks green/blue four times	76-100%
	Off	Fully charged
Firmware Update		
	Solid yellow	Firmware updating

* The color of the light depends on the current channel used. Take the green light as an example.

** The color of the light depends on the working mode. Take the green light as an example.

5. 3.5mm Audio Output Jack

For audio output to a camera.

6. Linking Button

Press and hold for two seconds to start linking. Press twice to switch between Mono and Stereo.

7. Expansion Port

Used for connecting to the phone adapter.

8. Data Port (USB-C)

9. Clip

1.3 Charging Case

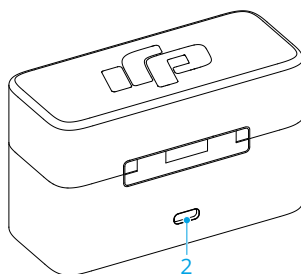
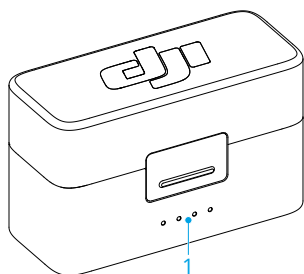

1. Battery Level LEDs

 LED is on

 LED is blinking

 LED is off

Battery Level During Charging (LEDs Blink in Sequence)

 76%-99%

 51%-75%

 26%-50%

 ≤25%

 Fully charged

Battery Level

 76%-100%

 51%-75%

 26%-50%

 10%-25%

 < 10%

2. Charging Port (USB-C)

- 💡 • Fully charge the battery at least once every three months to maintain battery health. If the battery is not used for an extended period, battery performance may be affected or may even cause permanent battery damage.
-

2 Using the Product

2.1 Charging

Charging with the Charging Case

Place the transmitters and the receiver in the charging case to start charging simultaneously. If the charging case runs out of power, use the provided USB-C cable to charge the case. The transmitter and receiver will automatically power on once removed from the charging case.

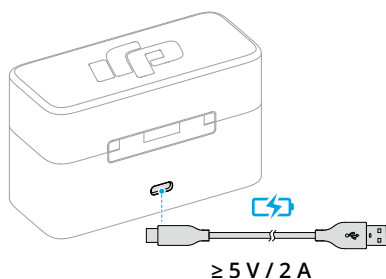

Charging with the Charging Dock

If the combo purchased does not include a charging case, attach the transmitter to the charging dock and use the provided charging cable to charge the transmitter and receiver.

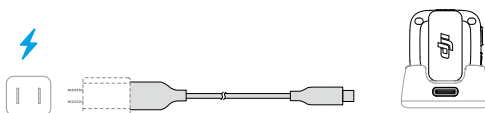
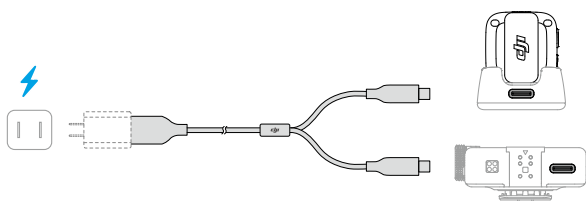

2.2 Installing the Windscreen

In outdoor or windy environments, use the windscreen to reduce wind noise and improve audio quality.

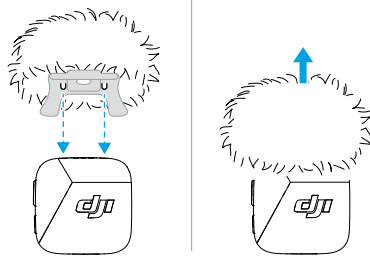

2.3 Wearing the Transmitter

The transmitter can be attached to clothing using the clip or magnet, or can be placed on a stable surface using the magnet.

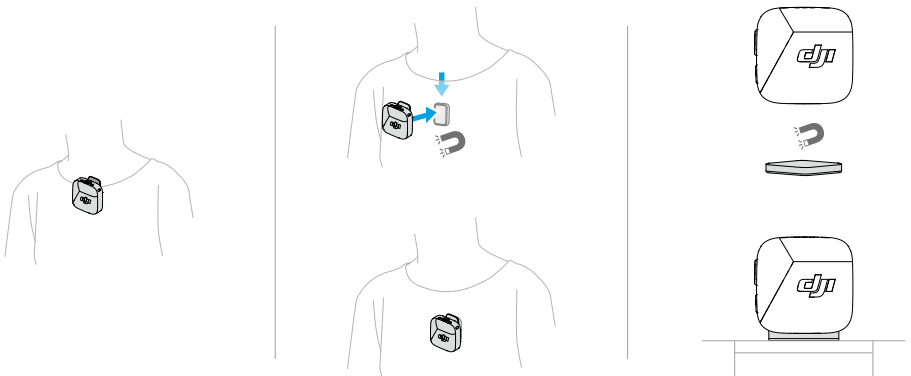

2.4 Linking the Transmitter and Receiver

Before first use, refer to [Updating Firmware](#) to update the device to the latest firmware version. The transmitter and receiver in the combos are linked by default. Follow the steps below to link the transmitter and receiver if they become unlinked.

Linking via the Charging Case

Place the transmitters and the receiver in the charging case to link them automatically.

Linking Manually

1. Press and hold the linking button on the transmitter for two seconds until the system status LED blinks blue and green alternately.
2. Press and hold the linking button on the receiver for two seconds until the transmitter status LED on the front of the receiver blinks green rapidly, indicating that the device is in linking status. The status LEDs will turn solid green after successful linking.

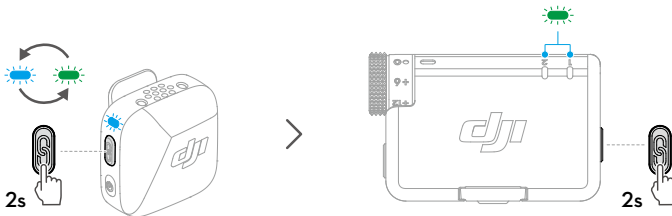

2.5 Using with a Phone

Install the receiver (RX) to the phone using the adapter, then clip or magnetically attach the transmitter (TX) to the collar. The transmitter can then capture audio for the phone.

- Press the linking button on the transmitter to start and stop recording.
- For extended filming or live streaming, it is recommended to use the adapter to attach the receiver to the phone. After installation, when using the charging cable to charge the receiver, the phone can be charged simultaneously.
- The Lightning adapter is sold separately.

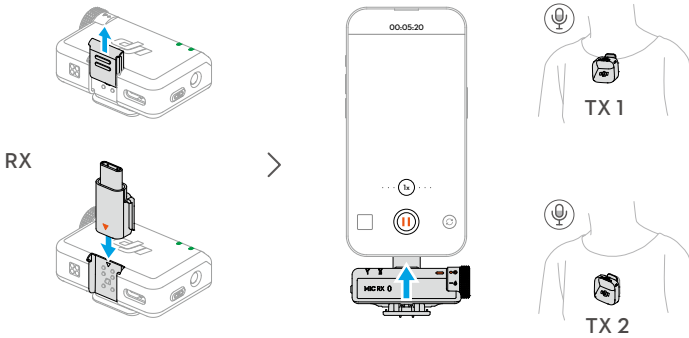

2.6 Using with a Camera

Mount the receiver to the camera using the clip and connect the audio cable. The transmitter will then capture audio for the camera.



- After installation and connection, visit <https://www.dji.com/mic-mini/downloads> and refer to the Instructions on Recommended Gain for Camera Setup to reduce the camera gain in order to prevent audio clipping.
- After adjusting the camera gain, it is recommended to increase the gain of the receiver for better audio quality.



2.7 Using with a Computer

Connect the receiver to the computer using the provided charging cable or adapter, and set the audio input options on the computer. The transmitter can then be used as an external microphone.

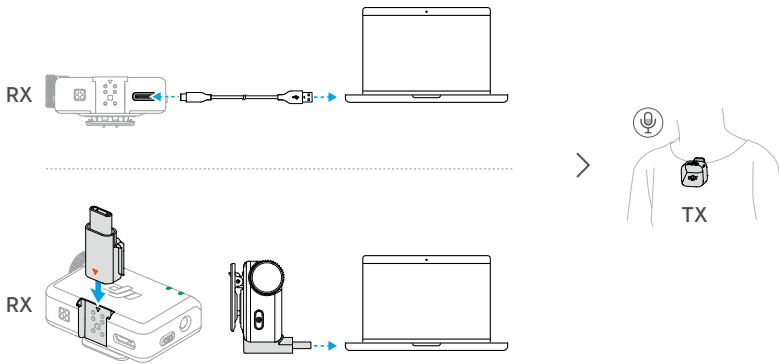

2.8 Transmitter Directly Connected to Filming Devices

The transmitter can connect to phones or DJI filming devices via Bluetooth.

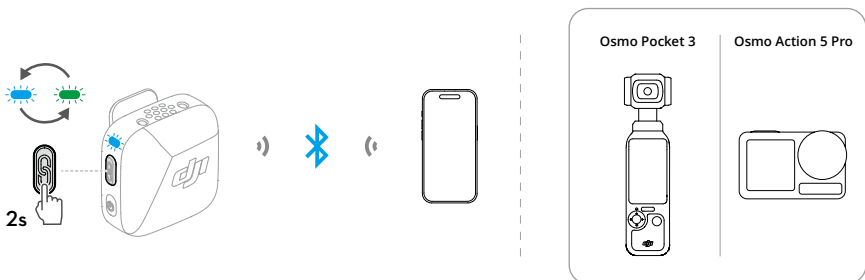

Connecting to a Phone

1. When the transmitter is powered on, press and hold the linking button on the transmitter for two seconds until the system status LED blinks blue and green alternately.

2. Enable Bluetooth on the phone and select DJI Mic Mini-XXXXXX among the searched Bluetooth devices to connect. Connection is successful when the status LED on the transmitter is in solid blue.

The transmitter will then function as an audio input device and can be used with third-party recording or live streaming applications.

Connecting to DJI Filming Devices

Enter the system settings interface of your DJI filming device. Tap **Wireless Microphone** and follow the on-screen instructions to complete the connection. Connection is successful when the status LED on the transmitter is on solid blue.

Press the linking button on the transmitter to start and stop recording on the filming device. Tap **Wireless Microphone** to configure audio-related settings for the transmitter.

3 Firmware Update and Parameter Adjustment

After connecting the microphone to the DJI Mimo app, you can update the firmware or adjust parameter settings using your phone.

3.1 Connecting to the DJI Mimo App

Connecting via the Adapter

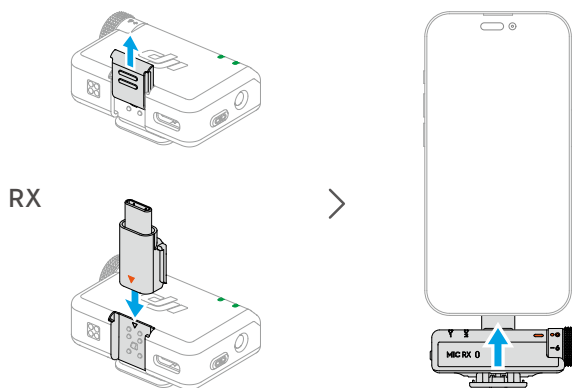

💡 • Make sure that the transmitter and receiver are linked.

Connecting via Bluetooth

Connecting the Transmitter

1. Refer to [Connecting to a Phone](#) to connect the transmitter to a phone via Bluetooth.
2. Open the DJI Mimo app to automatically search for nearby available devices. Tap to connect once the transmitter is discovered. After successful connection, the app will automatically enter the device settings interface.

Connecting the Receiver (iOS only)

1. When the receiver is powered off, press and hold the power button for six seconds. The system status LED on the receiver will blink green and then blink blue slowly, indicating that the receiver is ready to be connected.
2. Open the DJI Mimo app to automatically search for nearby available devices. Tap to connect once the receiver is discovered. After successful connection, the app will automatically enter the device settings interface.

3.2 Updating Firmware

Tap **About Devices** on the device setting interface of the DJI Mimo app to view the device name, SN code, and firmware version. Tap the firmware version to download and install the latest version.

-
-  When updating the firmware on an iOS device, disconnect the adapter and then connect the transmitter and receiver to the DJI Mimo app via Bluetooth separately.
-

3.3 Adjusting Parameters

In the device settings interface of the DJI Mimo app, you can view connected devices and their battery status or adjust parameters.

-
-  When the transmitter status LED is disabled, press any button can turn it on.
-

4 Appendix

4.1 Specifications

Visit the following website for specifications.

<https://www.dji.com/mic-mini/specs>

4.2 Aftersales Information

Visit <https://www.dji.com/support> to learn more about aftersales service policies, repair services, and support.

WE ARE HERE FOR YOU



Contact

DJI SUPPORT

This content is subject to change without prior notice.



<https://www.dji.com/mic-mini/downloads>

If you have any questions about this document, please contact DJI by sending a message to DocSupport@dji.com.

DJI is a trademark of DJI.

Copyright © 2024 DJI All Rights Reserved.