

User's Manual

INFIRAY OUTDOOR

RICO HYBRID HYH75W

Rugged Infrared Compact Optic



WARNING! ITAR REQUIREMENTS

These products may be subject to export and foreign trade control laws of the United States and may not be exported without prior approval of the U.S. Department of State. Learn more at irayusa.com/ITAR.

FCC ID: 2AY3N-HYBRID

This device complies with part 15 of the FCC Rules. Operation is subject to the following two conditions: (1) This device may not cause harmful interference, and (2) this device must accept any interference received, including interference that may cause undesired operation.

CAUTION: Changes or modifications not expressly approved by IRayUSA could void the user's authority to operate the equipment.

NOTE: This equipment has been tested and found to comply with the limits for a Class B digital device, pursuant to part 15 of the FCC Rules. These limits are designed to provide reasonable protection against harmful interference in a residential installation. This equipment generates, uses and can radiate radio frequency energy and, if not installed and used in accordance with the instructions, may cause harmful interference to radio communications. However, there is no guarantee that interference will not occur in a particular installation. If this equipment does cause harmful interference to radio or television reception, which can be determined by turning the equipment off and on, the user is encouraged to try to correct the interference by one or more of the following measures:

- Reorient or relocate the receiving antenna.
- Increase the separation between the equipment and receiver.
- Connect the equipment into an outlet on a circuit different from that to which the receiver is connected.
- Consult the dealer or an experienced radio/TV technician for help.

This device was tested for typical body-supported operations and use. To comply with RF exposure requirements, a minimum separation distance of 0.5cm must be maintained between the user's body and the handset, including the antenna. Third-party belt-clips, holsters, and similar accessories used by this device should not contain any metallic components. Body accessories that do not meet these requirements may not comply with RF exposure requirements and should be avoided. Use only the supplied or an approved antenna.

WARNING: CHOKING HAZARD

Children under 3 years old can choke or suffocate on small parts of this product. This product is not a toy; keep out of reach of children.

TABLE OF CONTENTS

1. Overview	2
2. Features	2
3. Tech Specs	3
4. Accessories	4
5. Components and Controls	5
6. Description of Control Buttons & Shortcuts ...	6
7. Quick Start Guide	8
8. Charging the Battery Pack	10
9. Installing the Battery Pack.....	11
10. Removing the Battery Pack.....	12
11. Battery Safety Warnings	12
12. External Power Supply	13
13. Mounting the RICO HYBRID.....	14
14. Operating Instructions	15
15. Zeroing the RICO HYBRID.....	22
16. Non-Uniformity Correction.....	23
17. Photography and Video Recording	24
18. Accessing the Internal Memory	27
19. Using The InfiRay Outdoor App	28
20. Bluetooth Remote Control	28
21. Digital Zoom	29
22. Picture in Picture (PIP).....	29
23. Region of Interest (ROI)	29
24. Clip-On Mode	30
25. Adjusting Clip-on Mode Screen Position	30
26. BDC Reticle	31
27. Ballistic Turret.....	33
28. Main Menu Options and Descriptions.....	34
29. Basic Inspection	53
30. Basic Maintenance	53
31. Warranty.....	54
32. General Troubleshooting	55
33. Notes	55

1. OVERVIEW

The InfiRay Outdoor RICO HYBRID HYH75W fuses the capabilities of a thermal clip-on and a thermal weapon sight to create a new breed of thermal device. The HYH75W has a 75mm lens and sports a flat dark-earth Cerakote finish. It provides versatility and performance, as well as compatibility with day optics up to 10× as an inline clip-on sight. The combination of the HYBRID's low-distortion eyepiece and a 1.03-inch large-format 2560×1920 AMOLED display provides comfortable viewing as a dedicated sight while still maintaining the pixel density and resolution required for use as a thermal clip-on. The HYH75W also boasts advanced features such as compatibility with a 1,000-yard laser rangefinder, a custom reticle generator, and an onboard ballistic solver. The HYH75W comes with all the features night hunters love such as mobile streaming over Wi-Fi and audio/video recording.

2. FEATURES

- 12 μm high-performance thermal detector
- ≤25 mK sensitivity
- High image quality
- Magnesium housing
- Quick-change rechargeable battery pack
- Maximum detection range 3600 yards
- HD 2560×1920 AMOLED display with low-distortion eyepiece
- High frame frequency: 50Hz
- Compatible with ILR-1000-2 Laser Rangefinder Module (optional/not included)
- Advanced recoil-mitigating mount for improved accuracy
- Multiple reticle types and color options
- Onboard ballistic solver and BDC reticle
- Recoil activated video
- Standalone and clip-on optic modes
- Multiple zero profiles and ranges
- Digital Zoom: ×1/×2/×4/×8
- Built-in 64 GB storage to support image capture and video recording
- Built-in Wi-Fi module
- Mobile device App compatible
- ROI (Region of Interest) mode
- Built-in digital compass and gravity sensor
- Picture in Picture (PIP)
- User-friendly interface
- Pixel calibration functions

3. TECH SPECS

RICO HYBRID	HYH75W
SENSOR	
Resolution	640×512
Pixel Size	12 μm
Frame Rate	50Hz
Sensor Sensitivity	≤25 mK
Image Processing	MATRIX III
Core	InfiRay Micro II 640
OPTICS	
Objective Lens	75 mm f/1.0
Magnification	4×
Digital Zoom	8×
Field of View	5.9° × 4.4°
Detection Range	3600 Yards
Display Type	1.03-inch Large-format AMOLED
Display Resolution	2560×1920
Color Palettes	White Hot, Black Hot, Red Hot, Iron Red, Rainbow, Outline
Reticle Types	9 (7 Static, 1 DIY, 1 BDC)
Reticle Colors	Black, White, Red, Green, Blue
Mounting System	Picatinny MIL-STD 1913 Rail
P.I.P.	Yes
Rangefinder	ILR-1000-2 LRF (Optional/Not Included)
Eye Relief	60 mm
Diopter Range	-4 to +2
ELECTRONICS	
Onboard Recording	Video, Recoil-Activated Video, and Image
Onboard Storage	64 GB
Wireless Connectivity	Image and Video via App.
Data/Power Connector	USB-C
Power Supply	USB-C External, IBP-1H Li-ion Battery Pack (6+ Hours)
Start Up Time	<10 Seconds, Instant from Standby
PHYSICAL	
Size	12.20" × 4.13" × 3.58"
Weight	45.08 Oz
ENVIRONMENTAL/WARRANTY	
Warranty	5 Years
Housing Material	Magnesium
Ingress Protection	IP67
Operation Temperature	-4°F~122°F
Max. Recoil	1000 g/s ² (300 Win./7mm Mag)

4. ACCESSORIES

The RICO HYBRID HYH75W rifle scope ships with everything you need to get out and hunt.

- 75mm Objective Lens Cap
- Standard Rubber Eyeguard
- IRAY-AC107 Advanced Recoil-Mitigating Picatinny Mount for RICO HYBRID
- Adapter Bracket
- M3 and M5 Screws for the Mount and Adapter
- 2.5mm and 3mm Hex Keys and Spanner Tool
- Bluetooth Remote Control
- USB-C to Analog RCA/USB Cable 36"
- IBP-1H Battery 4400 mAh
- IBC-1 Battery Charger
- USB Power Adapter
- Soft Case
- Lens Cloth
- User Manual



Optional accessories, such as the IRAY-AC107 Advanced Recoil-Mitigating Picatinny Mount and ILR-1000-2 Laser Rangefinder Module, as well as various replacement accessories, are available for purchase. Contact 800-769-7125 or irayusa.com/support.

5. COMPONENTS AND CONTROLS

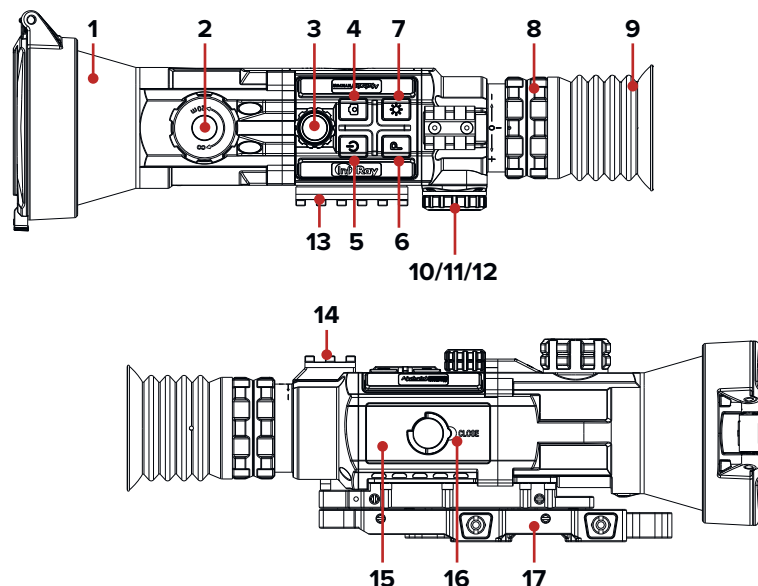

- 1 Objective Lens Cap
- 2 Objective Lens Focus Knob
- 3 Rotary Encoder
- 4 Photo Button
- 5 Power Button
- 6 Palette Button
- 7 Display Brightness Button
- 8 Eyepiece / Diopter Adjustment Ring
- 9 Eyeguard
- 10 USB-C Cover
- 11 USB-C Port
- 12 Battery Indicator LED
- 13 Side Accessory Rail
- 14 Top Accessory Rail
- 15 IBP-1H Battery Pack
- 16 Battery Pack Pull-Ring
- 17 IRAY-AC107 Advanced Recoil-Mitigating Picatinny Mount

6. DESCRIPTION OF CONTROL BUTTONS AND SHORTCUTS



Power Button 		
Current Screen, Menu, or Device Status	Short Press	Long Press
Device off	---	Power on the device
Home screen	Perform a non-uniformity correction (NUC)	Power off the device / enter standby mode
Main menu	Return to previous menu without saving changes	---
In standby mode	Exit standby	---
Reticle zeroing interface	Deselect current axis of movement; exit interface without saving	---

Photo Button 		
Current Screen / Menu	Short Press	Long Press
Home screen	Take photo	Start / stop recording video

Palette Button 		
Current Screen / Menu	Short Press	Long Press
Home screen	Adjust the imaging mode	Adjust the color palette

Brightness Button 		
Current Screen / Menu	Short Press	Long Press
Home screen	Adjust the display brightness	Turn the PIP window on / off

Brightness Button  + Rotary Encoder		
Current Screen / Menu	Short Press	Long Press
Advanced menu	---	Activate / deactivate reticle

Brightness + Photo Button  + 		
Current Screen / Menu	Short Press	Long Press
Home screen	Turn ROI feature on / off	---
Reticle zeroing interface	---	Freeze image to keep reticle centered on aiming point; press again to clear
Home screen (in clip-on mode only)	---	Enter the clip-on mode screen adjustment interface

Rotary Encoder				
Current Screen / Menu	Short Press	Double-Click	Long Press	Rotate
Home screen	Enter the quick menu	Enter the ballistic turret interface	Enter the main menu	Adjust the digital zoom level
Ballistic turret interface	Select X, Y, or zoom	Exit the ballistic turret interface	---	Adjust the value of X, Y, or zoom
Quick menu	Enter the submenu; confirm submenu changes and return to the previous menu level	---	Save changes and return to the home screen	All menus and submenus: Move through menu options; Defective pixel correction, file management, & reticle zeroing interfaces: Switch between interface options; move reticle or cursor position Clockwise: Move right / up Counterclockwise: Move left / down
Main menu				
Reticle zeroing interface	Select or deselect the axis of movement (X or Y)			
File management, clip-on mode screen adjustment, & defective pixel correction interfaces	Select or deselect an interface button			

Rotary Encoder + Photo Button 		
Current Screen / Menu	Short Press	Long Press
Home screen	---	Enable / disable clip-on mode

NOTE: Consult the manual that comes with your ILR-1000-2 Laser Rangefinder Module (optional/not included) for rangefinder shortcuts.

7. QUICK START GUIDE

Step 1: Prepare to Use the RICO HYBRID

1. Compare the box contents to the accessories list and examine each for any shipping damage. See **Accessories** on page 4.
2. Check the lens to ensure there are no smudges or dirt present. Clean with the included lens cloth, if necessary.
3. Charge the battery (15). See **Charging the Battery Pack** on page 10.
4. Install the eyeguard (9).
5. Mount the RICO HYBRID to the weapon. See **Mounting the RICO HYBRID** on page 14.

Step 2: Turn On the RICO HYBRID

1. Open the objective lens cap (1).
2. Long press the **Power**  **Button** for 3 seconds to power on the RICO HYBRID. The InfiRay Outdoor logo will appear.
3. Rotate the diopter adjustment ring (8) of the eyepiece until the interface icons are clear.

WARNING: Do not point the objective lens toward intense energy sources, such as the sun. This may render the electronic components inoperative. The warranty does not cover damage caused by improper operation.

Step 3: Adjust Settings in the Quick Menu

Short press the **Rotary Encoder** to enter the quick menu to adjust the following settings (see **Using the Quick Menu** on page 19):





1. Set the image brightness level, from 0–9.
2. Set the image contrast level, from 0–9.
3. Set image sharpness level, from 0–9.
4. Set the non-uniformity correction (NUC) mode to automatic (A), manual (M), or background (B).
5. Select the reticle type, 1–7, or the DIY reticle.
6. Set the reticle color to white, black, red, green, or blue.
7. Select a zero distance from the three preset options.

Step 4: Adjust Device Settings in the Main Menu

1. Long press the **Rotary Encoder** to enter the main menu (see **Main Menu Options and Descriptions** on page 34 for detailed instructions) to:
 - a. Turn on the compass.
 - b. Set the photo settings to single shot, burst, or self-timer.

- c. Set the image hue to cool or warm.
- d. Calibrate the compass.
- e. Turn on the microphone.
- f. Turn on recoil activated video.
- g. Set the date and time.
- h. Set the unit of measure to meters or yards.

2. From the home screen:

- a. Rotate the **Rotary Encoder** to zoom in and out on the observed object.
- b. Long press the **Palette**  **Button** to set the color palette to white hot, black hot, red hot, iron red, rainbow, or outline.
- c. Short press the **Palette**  **Button** to set the imaging mode to clear, highlight, or fog.
- d. Short press the **Brightness**  **Button** to set the display brightness level, from 0–10. A brightness  icon and indicator bar will appear in the lower-left corner of the screen.
- e. Long press the **Brightness**  **Button** to turn on the PIP window. See **Picture in Picture (PIP)** on page 29.

Step 5: Activate the Reticle

The reticle may be inactive when the RICO HYBRID is powered on for the first time. To activate the reticle, or to deactivate it at a later time:

1. From the home screen, long press the **Rotary Encoder** to enter the main menu.
2. Rotate the **Rotary Encoder** to move to the settings menu item.
3. Short press the **Rotary Encoder** to enter the settings submenu.
4. Long press the **Rotary Encoder** and the **Brightness**  **Button** at the same time for 3 seconds to activate the reticle and hidden reticle and zeroing menu items.

Step 6: Zero the RICO HYBRID

1. Zero the rifle scope. See **Zeroing the RICO HYBRID** on page 22.
 - a. Select the gun type, A, B, or C.
 - b. Select the bullet type, 1, 2, or 3.
 - c. Select, or customize, a preset zero distance that matches the target distance.
 - d. Zero the reticle.

8. CHARGING THE BATTERY PACK

The RICO HYBRID rifle scope comes with a long-lasting rechargeable lithium-ion battery pack, which allows for 6+ hours of operation. The IBP-1H battery pack uses a cam-locking mechanism to ensure quick and secure battery changes in the field. Fully charge the battery pack before using the RICO HYBRID for the first time.

Charging with the Battery Charger

1. Insert a battery pack (15) into the battery charger (18). Align the slots (A) on the edge of the battery pack with the pins (B) on the inside of the charger.
2. Connect the USB-C end of the data cable (19) to the USB-C port (C) on the battery charger.
3. Connect the standard USB end of the data cable to:
 - a. The included 5V–2A USB power adapter; **OR**
 - b. Any standard USB 3.0 port on a laptop or computer.
4. During charging, the LED status indicator (D) on the battery charger will be solid red.

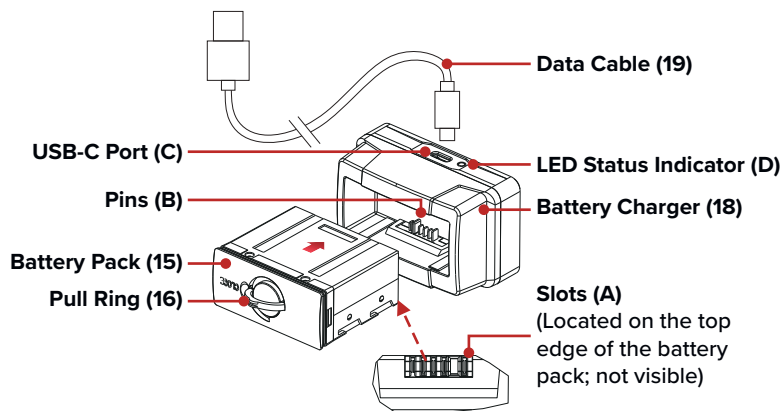

5. When fully charged, remove the battery pack from the battery charger.
 - a. The LED status indicator will turn solid green when the battery is fully charged. Do not overcharge.

NOTE: When the LED status indicator flashes red, the battery charger is connected to a power source but no battery pack is installed.

WARNING: Never use the battery charger with a USB power adapter that is greater than 5V–2A.

Charging via the USB-C Port

1. Open the USB-C cap.
2. Connect the USB-C end of the data cable (19) to the USB-C port (11) on the side of the RICO HYBRID.
3. Connect the standard USB end of the data cable to:
 - a. The included 5V–2A USB power adapter; **OR**
 - b. Any standard USB 3.0 port on a laptop or computer; **OR**
 - c. An external power supply, such as a USB power bank.
4. During charging:
 - a. The battery indicator LED (12) next to the USB-C port is red during charging.
 - b. In the status bar, the battery status (50) icon which shows the current battery percentage, alternates with the battery charging (🔋) icon.
5. When fully charged, disconnect the charging cable.
 - a. The battery indicator LED (12) will turn green when the battery is fully charged. Do not overcharge.

NOTES:

- You may charge and operate the RICO HYBRID at the same time.
- The battery status (50) icon turns red when the battery is below 20%; charge right away to avoid over-discharge and a reduction in battery capacity or service life.

9. INSTALLING THE BATTERY PACK

1. Lift the pull-ring (16) on the battery pack (15) and rotate it clockwise 90 degrees until it is horizontal to the battery pack.
2. Position the battery pack face up with the slots (A) facing up.
3. Align the slots (A) on the edge of the battery pack with the pins (B) on the inside of the battery compartment of the RICO HYBRID, then slide the battery pack into the opening.

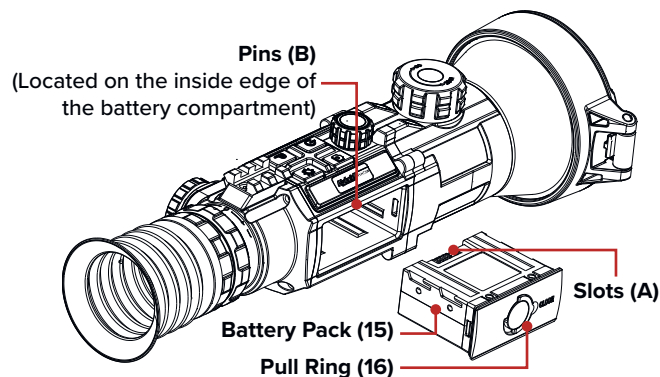

4. Firmly press the battery in to fully insert it.
5. Rotate the pull-ring counterclockwise 90 degrees to the vertical position to lock the battery pack in place.
6. Flip the pull-ring down so that it is flush with the battery pack.

WARNING: The RICO HYBRID can only be powered by a factory-supplied IBP-1H battery pack. Using any other battery pack may cause irreparable damage to the rifle scope or cause a fire. Any damage from using an improper battery pack will not be covered by warranty.

10. REMOVING THE BATTERY PACK

To remove the battery pack from the RICO HYBRID:

1. Lift the pull-ring (16) on the battery pack (15) and rotate it clockwise 90 degrees until it is horizontal to the battery pack.
2. Pull the battery pack out.

11. BATTERY SAFETY WARNINGS

WARNING: Only use the battery charger supplied with the battery pack. The use of any other charger may irreparably damage the battery pack or the charger and may cause a fire. Any damage from using an improper battery charger will not be covered by warranty.

WARNINGS:

- Do not use a battery charger, power adapter, or USB cable that has been modified or damaged.
- Do not expose the battery to high temperatures or flames, and do not immerse in water.
- Do not leave the battery unattended while charging.
- Do not leave the battery in the charger for long periods after full charge is reached. Charging time should not exceed 24 hours.
- Keep the battery pack out of the reach of children and pets.
- The battery is equipped with short-circuit protection. However, any situation that may cause short-circuiting should be avoided.
- Do not disassemble, modify, hit, or drop the battery pack.
- Do not connect the battery to any external device with an electrical current that exceeds permitted levels.
- Do not connect an external device with a current supply that exceeds a 3.0 USB port.

To maintain optimal battery capacity and service life:

- Avoid storing a fully charged or discharged battery for long periods. Partial charging of the battery is necessary if the battery will be stored for an extended period.
- Do not charge an extremely cold battery without bringing it into a warm environment. Let the battery warm up for 45 minutes before charging.
- Charge the battery at a temperature range from 32°F to 113°F; otherwise, the service life of the battery may be reduced.
- The recommended operating temperature range is -4°F to 122°F. Avoid using the battery above the maximum or below the minimum recommended temperature range as this may decrease the battery capacity or service life.

12. EXTERNAL POWER SUPPLY

The RICO HYBRID supports the use of a 5V external power supply, such as a mobile power bank. To connect to an external power supply:

1. Open the USB-C cover (11).
2. Connect the USB-C end of the data cable (19) to the USB-C port (11) on the side of the RICO HYBRID.
3. Connect the other end of the data cable to the external power supply.
4. The RICO HYBRID will switch to operation from the external power supply, and the internal battery pack will begin slowly charging.
5. In the status bar, the battery status (50) icon will alternate with the battery charging (🔌) icon.
6. If the external power supply is disconnected, the RICO HYBRID will automatically switch to the battery pack, if installed, without powering off.

NOTE: Do not connect the RICO HYBRID to an external device with a power supply that exceeds the 3.0 USB cable.

13. MOUNTING THE RICO HYBRID

Installing the IRAY-AC106 Mount

Before using the RICO HYBRID, install the IRAY-AC107 Advanced Recoil-Mitigating Picatinny Mount (17) to the mount interface on the base of the RICO HYBRID.

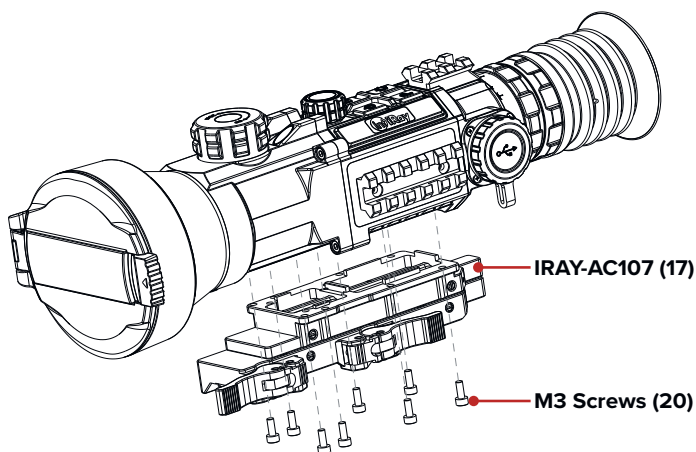

1. Install the IRAY-AC107 (17) to the base of the RICO HYBRID using a 2.5mm hex key and the M3 screws (20) supplied in the package.
2. Install the RICO HYBRID to the rifle and adjust its position so that it produces a clear image and is comfortable for the shooter.
3. When the location is suitable, remove the M3 screws one at a time and apply a small amount of blue Locktite 242 to the threads.
4. Reinsert each screw and tighten to 20 in/lbs.
5. Allow the threadlocker to dry.

NOTE: Please note, torque is inch-pounds, NOT foot-pounds. If you do not have a torque wrench, apply until snug. Do not overtighten.

When the threadlocker is dry, install the mount and rifle scope to the Picatinny rail of your rifle.

1. Press the locking button (21) and pull the locking lever (22) to open each throw lever.
2. Install the mount to the Picatinny rail.

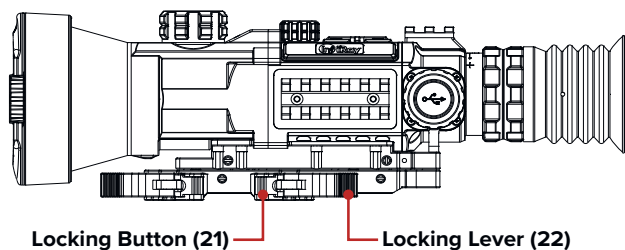

3. Press the levers closed to lock the mount in place. You will hear the lever and locking button click.

The RICO HYBRID is now ready to be zeroed. See **Zeroing the RICO HYBRID** on page 22 for instructions.

Adjusting the Throw Lever Tension

If necessary, you may loosen or tighten the tension of the throw levers by adjusting the nuts (23).

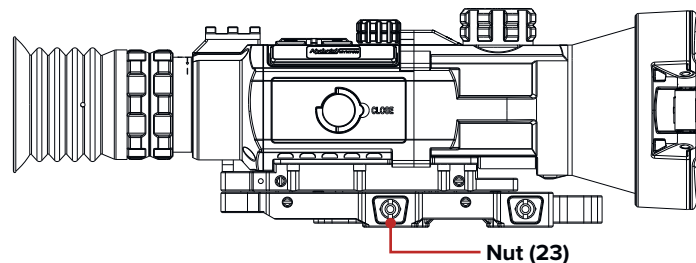

1. Open the throw levers. This will cause the adjustment nuts (23) to protrude on the opposite side of the mount.
2. Use the prong-side of the included spanner tool to turn the adjustment nut clockwise to tighten, or counterclockwise to loosen, to achieve the correct amount of tension. You should not feel any tension on the locking lever when closing until it reaches a 45-degree angle.

14. OPERATING INSTRUCTIONS



WARNING!

Don't point the objective lens towards any intense energy sources, such as laser radiation or the sun. This may render the electronic components inoperative. The warranty does not cover damage caused by improper operation.

Using the Control Buttons



The RICO HYBRID is operated via four control buttons and a metal tactile Rotary Encoder. The easy-to-find Rotary Encoder provides audible and tactile feedback when twisted or pressed. The control buttons and Rotary Encoder can be used to perform shortcut operations from the home screen, as well as in the menu and full-screen interfaces. See **Description of Control Buttons and Shortcuts** on page 6 for shortcut button details.

Powering On

1. Open the objective lens cap (1).
2. Long press the **Power**  **Button** for 3 seconds to turn on the rifle scope. The InfiRay Outdoor logo will appear.
3. To determine the current battery charge, check the battery status  icon in the top status bar.

Powering Off and Entering Standby Mode

To power off the RICO HYBRID:

1. Long press the **Power**  **Button**. The shutdown screen will open, showing a 3-second countdown.
2. Continue holding the **Power**  **Button** until the 3-second countdown completes.
3. “Data saving...” appears on the screen and the RICO HYBRID will shut down automatically after saving.

NOTE: Releasing the **Power**  **Button** at any time before the countdown reaches zero will stop the shutdown process and the rifle scope will enter standby mode. Short press the **Power**  **Button** to exit standby mode.



WARNING: If using an external power supply, do not remove the power supply when saving data, as the data may not be saved.

STANDBY MODE

Standby mode may be activated to conserve battery life.



Manually Enter Standby Mode

The user may enter standby mode manually at any time.

1. To enter standby from the home screen:
 - a. Long press the **Power**  **Button** to bring up the shutdown screen.
 - b. Release the **Power**  **Button** during the 3-second shutdown countdown to manually enter standby mode.
2. Short press the **Power**  **Button** to exit standby.

Set the RICO HYBRID to Enter Standby Mode Automatically

The rifle scope may be set to automatically enter standby mode.

1. In the main menu, select the standby  time, 5, 10, 20, 30, or 60 minutes. Once set, the RICO HYBRID will automatically enter standby according to the specified length of inactivity.
2. Short press the **Power**  **Button** to exit standby.

NOTES:

- When **5min**, **10min**, **20min**, **30min**, or **60min** is selected:
 - The RICO HYBRID will enter standby mode automatically when it is tilted up or down at an angle of more than 70° or left or right at an angle of more than 30°.
 - The RICO HYBRID will not enter standby mode while it is in a level firing position.
- When **off** is selected, standby mode is turned off and the rifle scope will operate until the battery runs out.
- See **Main Menu > Standby** on page 36 for instructions.

Adjusting the Focus

ADJUSTING THE DIOPTER/EYEPIECE

1. Rotate the eyepiece diopter adjustment ring (**8**) at the rear of the rifle scope right or left until the user interface is clear.
2. Look closely to ensure all screen symbols, the status bar, and the reticle appear sharp and in focus. No additional diopter adjustments are required unless the user wishes to make changes.

NOTES:

- After the initial adjustment, there is no need to rotate the eyepiece adjustment ring (**8**) for long distances or other conditions.
- If necessary during standard use, the objective lens focus knob (**2**) may be rotated to adjust fine focus on the target object being observed. See **Focusing the Objective Lens** below.

FOCUSING THE OBJECTIVE LENS

To adjust the focus on the target object:

1. Rotate the objective lens focus knob (**2**) left or right to adjust fine focus.

NOTE: Re-adjusting the focus will be necessary if the distance to the target changes.

Activating / Deactivating the Reticle

The reticle may be inactive when the RICO HYBRID is powered on for the first time. To activate the reticle, or to deactivate it at a later time:

1. From the home screen, long press the **Rotary Encoder** to enter the main menu.
2. Rotate the **Rotary Encoder** to select the settings menu item.
3. Short press the **Rotary Encoder** to enter the settings submenu.
4. Long press the **Rotary Encoder** and the **Brightness**  **Button** at the same time for 3 seconds to activate the reticle and hidden reticle and zeroing menu items.

Status Bar Overview

The status bars at the top, sides, and bottom of the screen show information on the operating status of the RICO HYBRID.



- 1 Video Output:** Shows the video output status, on or off .
- 2 Imaging Mode:** Shows the set imaging mode, clear , highlight , or fog .
- 3 Color Palette:** Shows the set color palette, white hot , black hot , red hot , iron hot , rainbow , or outline .
- 4 Gun Type:** Shows the set gun type, A, B, or C.
- 5 Bullet Type:** Shows the set bullet type, 1, 2, or 3.
- 6 Non-Uniformity Correction (NUC) Mode:** Shows the icon for the selected non-uniformity correction (NUC) mode, automatic , manual , or background . Automatic is selected by default. A countdown timer icon will appear when 5 seconds remain until an automatic NUC.
- 7 Compass:** The compass displays at the top of the screen when turned on.
- 8 Digital Zoom:** Shows the real-time amplification, 4x, 8x, 16x, or 32x.
- 9 Microphone:** Shows the microphone status, on or off .
- 10 Battery:** Shows the current battery status, 1–100%. The battery status icon turns red when the battery is below 20%. When connected to an external power source, the battery status icon will alternate with the battery charging icon.
- 11 Time:** Shows the current time in 24-hour format.
- 12 Wi-Fi:** Shows the Wi-Fi status, on or off .
- 13 Bluetooth:** Shows the Bluetooth status, on or off .









- 14 File Management Status:** The file management unavailable icon displays when Wi-Fi or recoil activated video is turned on in the main menu, when a video is recording, and when the rifle scope is connected to a computer via the data cable.
- 15 Camera Icon:** Briefly appears when taking a photo.
- 16 Video Recording Status:** Shows the video recording status, on or unavailable . Video recording is unavailable when recoil activated video is on.
- 17 Recoil Activated Video Status:** Shows the recoil activated video status, on or off/unavailable . Recoil activated video is off by default. Recoil activated video is unavailable when a video recording is in progress.
- 18 Rangefinding Status:** Shows the selected rangefinding mode, CONT or SGL, when the laser rangefinder (optional/not included) is connected.
- 19 Target Distance:** Shows the target distance calculated by the optional laser rangefinder. A target distance may be entered manually in the quick menu when the LRF is not connected.
- 20 Zero Distance:** Shows the selected zero distance.
- 21 Pitch Angle:** The pitch angle displays when the compass is turned on.
- 22 Tilt Angle:** The tilt angle displays when the compass is turned on.
- 23 Standby Status:** Shows the standby icon and the status, off, 5min, 10min, 20min, 30min, or 60min.

Using the Quick Menu

In the quick menu, image brightness, contrast, and sharpness, NUC mode, target distance, reticle type and color, and zero distance may be quickly adjusted.



In the quick menu:





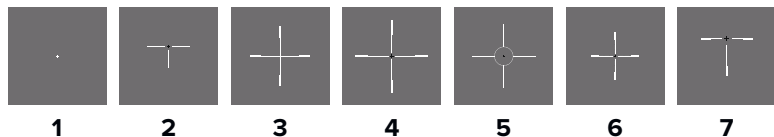

- Menu icons turn blue to indicate the current cursor position in the top-level menu and all submenus.
- Use the **Rotary Encoder** to navigate the quick menu:
 - **Rotate** to move left and right through the top-level menu or submenu options.
 - **Short press** to enter the submenu. Short press again to confirm submenu changes and return to the previous menu.
 - **Long press** to save any changes and return to the home screen.
- Short press the **Power**  **Button** to return to the previous menu without saving.
- When the cursor is in the top-level menu, the system will return to the home screen, after 5 seconds of inactivity. The system does not time out when the cursor is in a submenu.
- Upon exiting the main menu, the cursor location is stored for a single working session (until the RICO HYBRID is turned off). After restarting the RICO HYBRID and entering the menu, the cursor position will be at the first menu item.
- The eight quick menu options are:
 -  **Image Brightness:** Choose from levels 0–9.
 -  **Image Contrast:** Choose from levels 0–9.
 -  **Image Sharpness:** Choose from levels 0–9.
 -  **Calibration:** Set the non-uniformity correction (NUC) mode to automatic (A), manual (M), or background (B).
 -  **Target Distance:** Manually enter a target distance. Short press the Rotary Encoder to move between digits and rotate it to adjust the value of the selected digit.
 -  **Reticle Type:** Choose from type 1–7 (see **Reticle Types** below) or the DIY reticle. Please note, the BDC reticle overrides the Reticle Type selection.
 -  **Reticle Color:** Choose from white, black, red, green, or blue.
 -  **Reset Zeroing Distance:** Select a zero distance within the currently selected zeroing profile. Only the zero distances in the selected profile will be available for selection. The selected zero distance appears in the lower-left corner of the screen.

Reticle Types



CLIP-ON MODE QUICK MENU

Clip-on mode has abbreviated menu options. The clip-on quick menu combines elements from the standard quick menu and the main menu. Navigation of the clip-on mode quick menu is the same as described in the previous section; only the menu options are different:

-  **Bluetooth:** Turn Bluetooth on or off.
-  **Image Contrast:** Choose from levels 0–9.
-  **Image Sharpness:** Choose from levels 0–9.
-  **Calibration:** Set the non-uniformity correction (NUC) mode to automatic (A), manual (M), or background (B).
-  **Microphone:** Turn the microphone on or off.
-  **Status Auto Hide:** Turn the status bar auto-hiding on or off.
-  **Unit:** Set the unit of measure to meters or yards.

Navigating the Main Menu

From the home screen, long press the **Rotary Encoder** to enter the main menu.





In all menu interfaces:

- Menu icons turn blue to indicate the current cursor position in the top-level menu and all submenus.
- Use the **Rotary Encoder** to navigate the menu:
 - **Rotate** to move left and right through the top-level menu and submenu options, and to turn on or off toggle switches.
 - **Short press** to enter the submenu. Short press again to confirm submenu changes and return to the previous menu.
 - **Long press** to save any changes and return to the home screen.

- Short press the **Power**  **Button** to return to the previous menu without saving.
- When the cursor is in the top-level menu, the system will return to the home screen, after 5 seconds of inactivity. The system does not time out when the cursor is in a submenu.
- Upon exiting the main menu, the cursor location is stored for a single working session (until the RICO HYBRID is turned off). After restarting the RICO HYBRID and entering the menu, the cursor position will be at the first menu item.

15. ZEROING THE RICO HYBRID

RICO HYBRID features a “freeze” zeroing method. To zero the RICO HYBRID:



1. Set a suitable target at the desired zero distance.
2. Confirm that the rifle is empty, safe, and pointed in a safe direction, with no ammunition near the weapon.
3. Adjust the image and device settings following the steps in the **Quick Start Guide** on page 8, if you have not done so already.
4. Select the gun type, A, B, or C. See **Zeroing Profile > Gun Type** on page 38.
5. Select the bullet type, 1, 2, or 3. See **Zeroing Profile > Bullet Type** on page 38.
6. Based on the distance to the target you wish to zero, select a preset zero distance OR customize one of the preset zero distances to match. The RICO HYBRID supports custom zeroing distances of 1 to 999 meters or 1 to 999 yards. See **Zeroing Menu > Zero Distance** on page 41.
7. Ensure a stable platform and natural shooting position is achieved behind the rifle.
8. Load ammunition, aim, and take one good shot at the target.
9. Make your rifle safe and observe the location of impact on the target.
10. If the point of impact does not match the point of aim (the center of the reticle), adjust the X/Y position of the reticle. See **Zeroing Menu > Reticle Zeroing** on page 41.
11. In the submenu for the selected zero distance, center the reticle on the aiming point and long press the **Brightness**  and **Photo**  **Buttons** at the same time to freeze the image. The image freeze  icon will appear below the X/Y coordinates.
12. Rotate the **Rotary Encoder** to move between X and Y. Blue text indicates the cursor location.
13. Short press the **Rotary Encoder** to select the axis (X or Y) along which to move the reticle. A blue arrow appears to the left of the selected axis.

14. Adjust the X/Y position of the reticle until the reticle matches the point of impact.
 - a. Rotate the **Rotary Encoder** clockwise to move in the positive direction: X= Right and Y= Up.
 - b. Rotate the **Rotary Encoder** counterclockwise to move in the negative direction: X= Left and Y= Down.
 - c. Upon moving the reticle, a white dot appears onscreen, indicating the original reticle position for the selected axis.
15. Short press the **Rotary Encoder** to save and deselect the axis.
16. Repeat steps 12–15 above to move the cursor along the second axis.
17. Long press the **Rotary Encoder** to save and exit.
18. Take a confirmation shot—the point of impact should now match the point of aim. If not, adjust the X/Y position of the reticle again.

For detailed Zeroing instructions, please see **Zeroing Menu > Reticle Zeroing** on page 41.

16. NON-UNIFORMITY CORRECTION

A non-uniformity correction (NUC) allows a thermal imager’s sensors to correct its pixels and eliminate image defects caused by pixel drift. A NUC will be performed automatically each time the RICO HYBRID is powered on.

The RICO HYBRID has three NUC modes, automatic , manual , and background . The selected NUC mode appears on the left side of the status bar. For instructions on setting the NUC mode in the quick menu, see **Using the Quick Menu** on page 19.

Automatic Mode

In automatic mode (**A**), the RICO HYBRID will perform a NUC automatically according to the internal software algorithm. There is no need to close the objective lens cap (**1**) as the RICO HYBRID’s internal shutter covers the sensor.

A countdown timer will appear in the status bar when 5 seconds remain until an automatic NUC is performed. Pressing the **Power**  **Button** during the 5-second countdown will interrupt a pending NUC for approximately 5 minutes. The timer will appear only after the microbolometer temperature has stabilized—after approximately 10 minutes of continuous operation of the RICO HYBRID.

NOTE: A manual NUC (see below) may be performed at any time while in Automatic (**A**) mode.

Manual Mode

In manual mode (**M**), the user independently determines the need to perform a NUC based on the quality of the observed image. It is not necessary to close the objective lens cap (**1**) during a manual NUC, as the internal shutter covers the sensor.

To perform a manual NUC while in manual mode (or automatic mode):

1. From the home screen, short press the **Power**  **Button**.
2. A manual NUC is performed instantly.

Background Mode

In background mode (**B**), the user independently determines the need to perform a background NUC based on the quality of the observed image. A background NUC uses less power than an automatic or manual NUC because it does not use the internal shutter to cover the sensor; instead, the user must close the lens cap (**1**).

To perform a background NUC while in background mode:

1. Close the objective lens cap (**1**).
2. From the home screen, short press the **Power**  **Button**.
3. A prompt to close the lens cap (**1**) appears on the screen and the background NUC will be performed.

NOTE: If the lens is not properly covered, a temporary “image burn” will remain in the image until the next non-uniformity correction. This “image burn” is temporary and is not a defect or sign of permanent damage.



17. PHOTOGRAPHY AND VIDEO RECORDING

The RICO HYBRID is equipped with video recording and image capture. All videos and photos are automatically saved to the built-in 64 GB memory storage.

NOTE: Photo and video files are named with the time and date; therefore, it is recommended to set the date and time before using the photo and video functions. See **Advanced Menu > Date and Time** on page 47. Alternatively, the date and time may be synchronized in the InfiRay Outdoor App.

Photography



To take a photo:

1. From the home screen, short press the **Photo**  **Button**.
2. The camera  icon will appear on the left side of the screen to indicate a photo was taken.



Video Recording

To record video:

1. Turn on the microphone in the main menu if desired. See **Main Menu > Microphone** on page 35.
2. From the home screen, long press the **Photo**  **Button** to start a video recording.
3. When the video recording starts, the video  icon and the recording timer, in HH:MM:SS (hour, minute, second) format, appear on the left side of the screen.
4. When recording, short press the **Photo**  **Button** to take a photo.
5. Long press the **Photo**  **Button** to stop and save the video recording.



NOTE: When recording video, file management and recoil activated video are unavailable and notification icons appear on the left side of the screen.

Recoil Activated Video Recording

When recoil activated video is turned on in the main menu, a video is automatically recorded when a shot is taken. The RICO HYBRID will record 30 seconds before the shot and 30 seconds after the shot. The recoil activated video  icon and a 30-second timer will appear on the left side of the screen. See



Main Menu > Recoil Activated Video on page 37 for instructions.

NOTES:

- When multiple shots are taken within the same 30-second period, only one video will be taken.
- When recoil activated video recording is turned on, file management and standard video recording are unavailable and notification icons appear on the left side of the screen.

Video and Photography Notes

- You may enter and navigate the menu as normal during video recording. The user interface (the status bar, icons, and menu) is not captured in recorded video or photo files.
- Recorded photos and videos are saved to the memory card.
 - Photos are saved as IMG_YYYYMMDDhhmmss_XX.jpg.
 - Videos are saved as VID_YYYYMMDDhhmmss_XX.mp4.
 - YYYYMMDDhhmmss is year, month, day, hour, minute, second.
 - XX is a 2-digit counter number. The counter number cannot be reset. If a file is deleted from the internal memory, its counter number is not taken by another file.
- The maximum duration of a recorded video file is 5 minutes. After this time, video recording will begin a new file automatically.
- The number of recorded files is limited only by the capacity of the internal memory. The internal memory can store up to 1,800 photos, 600 videos, and 370 recoil activated videos.
- The oldest photos or videos are automatically replaced when memory storage reaches capacity.
- Regularly check the available memory storage space and transfer video footage and images to other storage media to free up memory space, as needed, in the file management interface. See **Main Menu > File Management** on page 43.

18. ACCESSING THE INTERNAL MEMORY

When the RICO HYBRID is turned on and connected to a computer via the included data cable, it is recognized by the computer as a flash memory (USB) drive. This allows the user to access the saved multimedia files and copy or delete any desired files.

To access the internal memory:

1. Turn on the RICO HYBRID.
2. Connect the USB-C end of the data cable (19) to the USB-C port (11).
3. Connect the standard USB end of the data cable to your computer.
4. Double-click **My Computer** on your computer desktop.
5. Double-click to open the device named **HYBRID_XXXX** to access the built-in memory.
 - a. The folder contains three multimedia subfolders, **VIDEO-CIF**, **PHOTO-CIF**, and **RAV-CIF**. The RAV-CIF folder contains the recoil activated videos.
 - b. Recorded photos and videos are separated into subfolders by date.
6. Select the desired files or folders to copy or delete.

NOTES:

- Check the available space in the internal memory storage in the RICO HYBRID's file management interface. See **Main Menu > File Management** on page 43. The memory storage availability listed when connected to a computer does not represent the actual memory availability, as the computer and device use different algorithms to calculate this value.
- The internal memory may be reformatted in the settings menu. See **Advanced Menu > Formatting** on page 51. Do not use a formatting application or tool to format the internal storage.

19. USING THE INFIRAY OUTDOOR APP

The RICO HYBRID can be operated using the InfiRay Outdoor App when connected to a tablet or smartphone or via Wi-Fi.



1. Download the App for free and install it on your device:
 - a. Scan a QR code to download it from the App Store or Google Play; **OR**
 - b. Download the App from any app store.
2. Connect the RICO HYBRID to Wi-Fi:
 - a. Turn on Wi-Fi. See **Main Menu > Wi-Fi** on page 34 for instructions.
 - b. Open the App and press the **ViewFinder**  icon on the home screen. Then, click the **Connect Device WiFi** button.
 - c. On the mobile device, go to **Settings > Wi-Fi**.
 - d. Select the RICO HYBRID from the list of Wi-Fi networks. It will appear in the list as “Hybrid_HYH75W_XXXX,” where XXXX is the four-digit device serial number.
 - e. Enter the Wi-Fi password and tap the **Join** button. The default password is 12345678.
3. Operate the RICO HYBRID via the App:
 - a. Take real-time photos and videos, with or without audio.
 - b. View, share, download, and delete photos and videos taken via the App, which are saved to the mobile device.
 - c. Change the Wi-Fi password and SSID.
 - d. Synchronize the date and time from the mobile device.
 - e. Update the RICO HYBRID firmware.

NOTE: When a factory reset is performed, the Wi-Fi SSID and password are reset to the defaults, Hybrid_HYH75W_XXXX and 12345678. See **Advanced Menu > Factory Reset** on page 52.

20. BLUETOOTH REMOTE CONTROL

The RICO HYBRID comes with a wireless remote control, allowing access to the control buttons from your rifle stock or a tripod. Consult the instruction sheet in the pouch with the remote for setup and use instructions.



21. DIGITAL ZOOM



The RICO HYBRID will quickly increase the base magnification by enlarging the image from 1 to 8 times digitally.

To use digital zoom:

1. From the home screen, rotate the Rotary Encoder clockwise to zoom in or counterclockwise to zoom out on the observed object. The real-time amplification 4×, 8×, 16×, 32×, appears on the right side of the status bar.

22. PICTURE IN PICTURE (PIP)

The Picture in Picture function opens a small floating window with a magnified image view at the top of the screen.

1. From the home screen, long press the **Brightness**  **Button**. A 2× zoomed image, centered on the reticle, will appear at the top of the screen. Please note that the PIP image is 2× that of the real-time magnification level shown in the status bar.
2. To exit PIP mode, long press the **Brightness**  **Button**.



NOTES: When the image in the main body of the screen is enlarged via digital zoom, the PIP image will enlarge accordingly.



23. REGION OF INTEREST (ROI)

The RICO HYBRID has a Region of Interest (ROI) feature which tells the thermal detector to focus on the center of the observed image.

To use the ROI feature:

1. From the home screen, short press the **Photo**  and **Brightness**  **Buttons** at the same time to turn on or off the ROI feature. A circular high-contrast, high-brightness region will appear in the center of the screen.



24. CLIP-ON MODE

By default, the RICO HYBRID is set to standalone mode for use as a dedicated thermal sight. In clip-on mode, the RICO HYBRID is compatible with day optics up to 10× as an inline clip-on sight. In clip-on mode, the screen size is reduced to be in unity (1×).

To enable or disable clip-on mode:

1. From the home screen, long press the **Rotary Encoder** and the **Photo**  **Button** at the same time.

NOTES:



- We recommend going no higher than 10× on any rifle scope used in clip-on mode as image performance will become unsatisfactory.
- In clip-on mode, the X/Y position of the screen may be adjusted so that the center of the screen matches up with the day scope reticle. See the next section.
- Clip-on mode has no main menu and has a unique quick menu. See **Clip-on Mode Quick Menu** on page 21.

25. ADJUSTING CLIP-ON MODE SCREEN POSITION

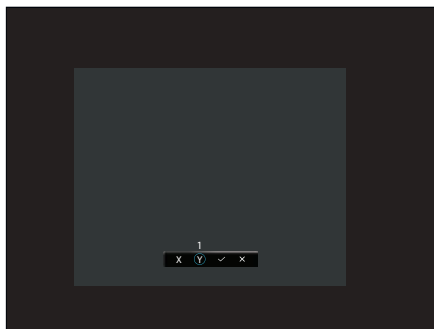
In clip-on mode, the display size is reduced to be in unity (1×). On your first use, it may be necessary to adjust the X/Y of the screen to collimate the RICO HYBRID to your reticle. If your POI and POA differ in clip-on mode, adjust the screen as you would adjust the reticle in the zeroing section.



To adjust the screen position:

1. On the home screen with clip-on mode enabled, long press the **Brightness**  and **Photo**  **Buttons** at the same time to enter the clip-on mode screen-position adjustment interface.
2. The screen-position adjustment interface has the following features:
 - 1 **X Button**: Move the screen along the X-Axis.
 - 2 **Y Button**: Move the screen along the Y-Axis.
 - 3 **✓ Button**: Save and return to the home screen.
 - 4 **✕ Button**: Exit the interface without saving.



3. To use the interface:

- a. Rotate the **Rotary Encoder** to move through the interface. The cursor position is indicated by a white outline around the button.
 - b. Short press the **Rotary Encoder** to select or deselect a button. Button selection is indicated by a blue outline around the button.
 - c. With the X or Y button selected, rotate the **Rotary Encoder** to move the X/Y position of the screen.
4. Adjust the X/Y position of the screen.
 - a. Rotate the **Rotary Encoder** clockwise to move in the positive direction: X= Right and Y= Up.
 - b. Rotate the **Rotary Encoder** counterclockwise to move in the negative direction: X= Left and Y= Down.
 - c. Rotate one click to move the reticle in the corresponding direction by 1 pixel. One full rotation (20 clicks) is equivalent to 20 pixels.
 5. Select the **✓ Button** to save the screen position and return to the home screen; **OR**
 6. Select the **✕ Button** to exit the interface without saving and return to the home screen.

26. BDC RETICLE

The RICO HYBRID's shooting table and ballistics solver function allow users to input ballistic information that matches their personal rifle and ammunition to create a custom BDC-style reticle. The RICO HYBRID will reference user-input data to provide real-time correction based on a target distance input by the user or provided by the optional LRF module.

To set up the shooting table:

1. Long press the **Rotary Encoder** to enter the main menu.
2. Rotate the **Rotary Encoder** to move to zeroing profile , and short press the **Rotary Encoder** to enter the submenu.
3. Rotate the **Rotary Encoder** to move to gun type , and short press the **Rotary Encoder** to enter the submenu.
4. Rotate the **Rotary Encoder** to move through the options, A, B, and C, and short press the **Rotary Encoder** to save and exit the submenu.
5. Select bullet type  to enter the submenu.
6. Select a bullet type of, 1, 2, or 3, then exit the submenu.

7. Select shooting table  to enter the submenu.
8. Select one of the three shooting table options, 500yd, 1000yd, or 2000yd to edit it.





9. Use the **Rotary Encoder** to customize the shooting table. Rotate to move through the range inputs in the table, short press to add data to a table cell, and long press to save the data point and exit the cell.



NOTE: It is not necessary to input data for each distance point, but more information will result in greater accuracy.

10. Long press the **Rotary Encoder** to save the changes made to your selected shooting table and exit the submenu.

To activate the BDC reticle:

1. In the zeroing profile  menu, select BDC reticle  to enter the submenu.
2. Rotate the **Rotary Encoder** to turn on the toggle. When turned on, a BDC-style reticle based on your customized shooting table is active and overrides the reticle set in the quick menu.
 - a. If you have already zeroed at the selected distance, the BDC reticle will reference that location as its zero position.
 - b. If a yardage stadia is missing from this reticle, it is too close to the others and will only be visible when you zoom in by rotating the **Rotary Encoder**.

To enable the ballistic solver function:

1. In the zeroing profile  menu, select ballistic solver  to enter the submenu.
2. Rotate the **Rotary Encoder** to turn on the toggle. When the ballistic solver is on, a secondary aiming point will be superimposed on the BDC reticle based



on your customized shooting table and the target distance. Five auxiliary points are positioned to the left and the right of the BDC reticle's solution result, offering the hunter additional aiming positions on both sides.

- a. The target distance is provided by the optional LRF module (see the documentation provided with the LRF for more information on its operation) or manually input in the quick menu (see **Using the Quick Menu** on page 19).
- b. A total of 10 auxiliary points are provided, each with a pair of points spaced 1MOA (3.375 MIL) apart, and they are updated along with the BDC reticle result.

NOTES:

- A zeroing distance of 50yd, 100yd, 200yd, 300yd, etc. must be selected in the zeroing  menu. See **Main Menu > Zeroing** on page 40.
- Ballistic data must be entered in the shooting table in MOA or MIL. See **Advanced Menu > Unit** for instructions on switching between units. This data can be obtained from a ballistics solver or your ammunition maker.
- Ballistics data should be verified on a known range before using it in the field.
- If the drop in your shooting table does not match the actual drop of your ammo/firearm, you can adjust, or true, the data in the table at any time based on your exact ballistics. This is normal and is not a result of a problem with the optic.

27. BALLISTIC TURRET

The RICO HYBRID supports a ballistic turret, enabling you to quickly fine-tune the position of the aiming reticle in both the X and Y directions. This ensures accurate shooting when sighting through the reticle.



1. From the home page, double-click the **Rotary Encoder** to enter the ballistic turret interface.
2. Short press the **Rotary Encoder** to move through the interface options, X, Y, and Zoom. The selected option will turn blue.
3. With **X** or **Y** selected, rotate the **Rotary Encoder** to adjust the position of the reticle in MOA.
4. With **Zoom** selected, rotate the **Rotary Encoder** to move through the four zoom options, $\times 4$, $\times 8$, $\times 16$, and $\times 32$.
5. Double-click the **Rotary Encoder** to save and exit the ballistic turret interface.

NOTES:

- When aiming with the BDC reticle, the ballistic turret can still be used, and the adjustment of the reticle will become the position of the aiming point.
- The reticle's position will not be permanently saved and will return to the initial position when the function is exited.
- When adjusting the reticle, each click of the Rotary Encoder represents a real movement of 0.275 MOA (0.93 MIL).
- The ballistic turret will not affect the reticle position data saved in your Zeroing settings.

28. MAIN MENU OPTIONS AND DESCRIPTIONS

Menu and submenu options, from left to right are:



- **Main Menu:** Wi-Fi, Compass, Microphone, Standby, Photo Setting, Recoil Activated Video, Zeroing Profile, Zeroing, File Management, Advanced Menu.
 - **Zeroing Profile Menu:** Gun Type, Bullet Type, Shooting Table, BDC Reticle, Ballistics Solver.
 - **Zeroing Menu:** Preset Zero Distances, Reticle Zeroing, and Custom Zero Distance.
 - **Advanced Menu:** Video Output, Bluetooth, Status Auto Hiding, Date and Time, Compass Calibration, Pixel Defect Correction, Image Hue, Unit, Formatting, Factory Reset, Info.

Menu option details, descriptions, and navigation instructions are listed in order on the following pages.

Wi-Fi

Turn Wi-Fi on / off

Turn on Wi-Fi to operate the scope via the InfiRay Outdoor App.

1. Long press the **Rotary Encoder** to enter the main menu.
2. Rotate the **Rotary Encoder** to select the Wi-Fi  menu item. Wi-Fi is selected by default when the menu is accessed for the first time.
3. Short press the **Rotary Encoder** to enter the submenu.
4. Rotate the **Rotary Encoder** to toggle Wi-Fi on / off. Wi-Fi status, on  or off , changes in real-time and appears in the status bar.
5. Long press the **Rotary Encoder** to confirm the selection and return to the home screen.



Compass



Turn the compass and gravity sensor on / off

1. Long press the **Rotary Encoder** to enter the main menu.
2. Rotate the **Rotary Encoder** to select the compass  menu item.
3. Short press the **Rotary Encoder** to enter the submenu.
4. Rotate the **Rotary Encoder** to toggle the compass and gravity sensor on / off. When turned on, the compass appears at the top of the screen, the pitch angle appears on the right side of the screen and the tilt angle appears in the lower-right corner.
5. Long press the **Rotary Encoder** to confirm the selection and return to the home screen.



Microphone

Turn the microphone on / off

1. Long press the **Rotary Encoder** to enter the main menu.
2. Rotate the **Rotary Encoder** to select the microphone  menu item.
3. Short press the **Rotary Encoder** to enter the submenu.
4. Rotate the **Rotary Encoder** to toggle the microphone on / off. The microphone status, on  or off , changes in real-time and appears in the status bar.
5. Long press the **Rotary Encoder** to confirm the selection and return to the home screen.





Standby

Set standby time

To conserve battery, the RICO HYBRID may be set to automatically enter standby mode after a specified length of inactivity.



1. Long press the **Rotary Encoder** to enter the main menu.
2. Rotate the **Rotary Encoder** to select the standby  menu item.
3. Short press the **Rotary Encoder** to enter the submenu.
4. Rotate the **Rotary Encoder** to move through the standby submenu options, 5min, 10min, 20min, 30min, 60min, or off. The standby status changes in real-time, and the standby  icon and status (5min, 10min, 20min, 30min, or 60min, or off) appear in the lower-right corner of the screen.
5. Long press the **Rotary Encoder** to confirm the selection and return to the home screen.
6. When standby is turned on, the RICO HYBRID will automatically enter standby mode after the set number of minutes of inactivity.
7. When in automatic standby mode, short press the **Power**  **Button** to exit standby and return to the home screen.

STANDBY NOTES:





- When **5min, 10min, 20min, 30min, or 60min** is selected:
 - The RICO HYBRID will enter standby mode automatically when it is tilted up or down at an angle of more than 70° or left or right at an angle of more than 30°.
 - The RICO HYBRID will not enter standby mode while it is in a level firing position.
- When **off** is selected, standby mode is turned off and the rifle scope will operate until the battery runs out.
- Standby mode may be manually activated from the home screen at any time.

Photo Settings

Set the photo settings



The RICO HYBRID has three photo settings, single-shot, burst, and self-timer. Self-timer mode will automatically take a photo after a 5-second delay. Burst mode will take a photo every second for 6 seconds.



1. Long press the **Rotary Encoder** to enter the main menu.
2. Rotate the **Rotary Encoder** to select the photo settings  menu item.
3. Short press the **Rotary Encoder** to enter the submenu.
4. Rotate the **Rotary Encoder** to move through the submenu options, single-shot , burst , and self-timer  modes. Single shot mode is selected by default.
5. Long press the **Rotary Encoder** to confirm the selection and return to the home screen.

Recoil Activated Video

Turn the recoil activated video on / off

1. Long press the **Rotary Encoder** to enter the main menu.
2. Rotate the **Rotary Encoder** to select the recoil activated video  menu item.
3. Short press the **Rotary Encoder** to enter the submenu.
4. Rotate the **Rotary Encoder** to toggle recoil activated video on / off. The recoil activated video icon  appears on the left side of the screen when turned on and a 30-second timer starts. When turned on, the rifle scope will record 30 seconds of video before a shot is taken and 30 seconds after.
5. Long press the **Rotary Encoder** to confirm the selection and return to the home screen.



Zeroing Profile



Adjust the zeroing and ballistic settings

In the zeroing profile menu, you can set the gun type and bullet type, edit the shooting table, and turn on or off the BDC reticle and ballistics solver.

1. Long press the **Rotary Encoder** to enter the main menu.
2. Rotate the **Rotary Encoder** to select the zeroing profile  menu item.
3. Short press the **Rotary Encoder** to enter the submenu.

ZEROING PROFILE MENU > GUN TYPE SUBMENU



Set the gun type

1. In the zeroing profile submenu, rotate the **Rotary Encoder** to select the gun type  menu item.
2. Short press the **Rotary Encoder** to enter the submenu.
3. Rotate the **Rotary Encoder** to move through the options, A, B, and C. The selection changes in real-time, and the gun  icon and selected type, A, B, or C, appear in the status bar.
4. Long press the **Rotary Encoder** to confirm the selection and return to the home screen.



ZEROING PROFILE MENU > BULLET TYPE SUBMENU

Set the bullet type

1. In the zeroing profile submenu, rotate the **Rotary Encoder** to select the bullet type  menu item.
2. Short press the **Rotary Encoder** to enter the submenu.
3. Rotate the **Rotary Encoder** to move through the options, 1, 2, and 3. The selection changes in real-time. The bullet icon  and type, 1, 2, or 3, appear in the status bar.
4. Long press the **Rotary Encoder** to confirm the selection and return to the home screen.



ZEROING PROFILE MENU > SHOOTING TABLE SUBMENU

Edit the shooting table

1. In the zeroing profile submenu, rotate the **Rotary Encoder** to select the shooting table  menu item.
2. Short press the **Rotary Encoder** to open the shooting table.
3. The offset corresponding to the zeroing distance must be entered in the shooting table. For example, if the zeroing distance is 50yd, data must be entered in the table cell below 50yd in the shooting table.
4. In the shooting table:
 - a. Input offsets corresponding to two or more distances to build a ballistic solution.
 - b. “-” indicates a value located below the zeroing point, and “+” indicates a value located above the zeroing point.
 - c. When “--” displays, no data has been input in the table cell.
 - d. The accepted range for data values is 00.00 to 99.99.
5. Long press the **Rotary Encoder** to close the table and return to the home screen.



ZEROING PROFILE MENU > BDC RETICLE SUBMENU

Turn the BDC reticle on / off

1. In the zeroing profile submenu, rotate the **Rotary Encoder** to select the BDC reticle  menu item.
2. Short press the **Rotary Encoder** to enter the submenu.
3. Rotate the **Rotary Encoder** to toggle the BDC reticle on / off. The BDC reticle is off by default.
4. When turned on, the BDC reticle is active and overrides the reticle set in the quick menu. If you have already zeroed at the selected distance, the BDC reticle will reference that location as its zero position.
5. Long press the **Rotary Encoder** to confirm the selection and return to the home screen.



ZEROING PROFILE MENU > BALLISTICS SOLVER

SUBMENU

Turn on the ballistics solver

1. In the zeroing profile submenu, rotate the **Rotary Encoder** to select the ballistics solver  menu item.
2. Short press the **Rotary Encoder** to enter the submenu.
3. Rotate the **Rotary Encoder** to toggle the ballistics solver on / off. The ballistics solver is off by default.
4. When the ballistic solver is on, a secondary aiming point will be superimposed on the BDC reticle based on your customized shooting table and the target distance provided by the optional LRF module or manually input in the quick menu.
5. Long press the **Rotary Encoder** to confirm the selection and return to the home screen.



Zeroing

Select or customize a zero distance

In the zeroing menu, you can select a preset zero distance, customize a preset zero distance, and adjust the reticle position for the selected zero distance. The RICO HYBRID supports custom zero distances of 1 to 999 yards or 1 to 999 meters.

NOTE: Before selecting or customizing a zero distance, please select a gun type (A, B, or C) and a bullet type (1, 2, or 3). See the **Zeroing Profile** section on page 38.



1. Long press the **Rotary Encoder** to enter the main menu.
2. Rotate the **Rotary Encoder** to select the zeroing  menu item.
3. Short press the **Rotary Encoder** to enter the submenu. Three zero distances are shown in the submenu.

ZEROING MENU > ZERO DISTANCE SUBMENU

Select or customize a preset zero distance

1. In the zero distance submenu, rotate the **Rotary Encoder** to select a zero distance option.
2. Short press the **Rotary Encoder** to enter the submenu for the selected zero distance.
3. In the submenu for the selected zero distance, you may:
 - a. Enter the reticle zeroing interface  to adjust the X/Y position of the reticle at the selected zero distance. See **Reticle Zeroing** on the next page.
 - b. Customize the selected preset zero distance as needed. See **Zeroing Menu > Customize Zero Distance** on page 43.

ZEROING MENU > ZERO DISTANCE SUBMENU > RETICLE ZEROING

Adjust the reticle position of the selected zero distance.





In the reticle zeroing interface, the X/Y position of the reticle may be adjusted to match the point of impact.

1. In the submenu for the selected zero distance, the reticle zeroing  menu item is selected by default. Short press the **Rotary Encoder** to select it and enter the reticle zeroing interface.
2. The reticle zeroing interface has the following features:
 - 1 **X:** Horizontal point of impact change (in cm or inches).
 - 2 **Y:** Vertical point of impact change (in cm or inches).



3 Freeze Icon: Appears when the image is frozen.

4 Reticle: Shows the new reticle position.

- Center the reticle on the aiming point and long press the **Brightness**  and **Photo**  **Buttons** at the same time to freeze the image. The image freeze  icon will appear below the X/Y coordinates.
- Rotate the **Rotary Encoder** to move between X and Y. Blue text indicates the cursor location.
- Short press the **Rotary Encoder** to select the axis (X or Y) along which to move the reticle. A blue arrow appears to the left of the selected axis.
- Adjust the X/Y position of the reticle until the reticle matches the point of impact.
 - X** (horizontal) is the windage and **Y** (vertical) is the elevation.
 - Upon moving the reticle, a white dot appears on the screen, representing the original reticle position for the selected axis.
 - Rotate the **Rotary Encoder** clockwise to move in the positive direction: X= Right and Y= Up.
 - Rotate the **Rotary Encoder** counterclockwise to move in the negative direction: X= Left and Y= Down.
 - Rotate one click to move the reticle in the corresponding direction by 1 pixel. One full rotation (20 clicks) is equivalent to 20 pixels.
 - When adjusting your zero at a distance of 50 yards, one click will change the impact point by 0.14" and one full rotation moves 2.9", as shown in the X and Y coordinate displays. At 100 yards that same click moves 0.29". At 200 yards one click moves 0.58".
 - Changing your zero distance will change the distance of your X/Y adjustments automatically. If your selected zero distance has a correction of 2.87" at 100 yards, it will automatically change to 5.76" if you change the zero distance to 200 yards.
- Save **OR** clear the reticle position along the selected axis.
 - Short press the **Power**  **Button** to clear the reticle position for the selected axis, returning the reticle to the original position for that axis; **OR**
 - Short press the **Rotary Encoder** to save the position for the selected axis and deselect it. The blue arrow will disappear.
- Repeat steps 4–7 to move the reticle to the desired location.
- Long press the **Rotary Encoder** to save and return to the home screen.
- Take a confirmation shot—the point of impact should now match the point of aim. If not, adjust the X/Y position of the reticle again.

ZEROING MENU > ZERO DISTANCE SUBMENU > CUSTOMIZE ZERO DISTANCE 000 m

Customize a preset zero distance

The RICO HYBRID supports custom zero distances of 1 to 999 yards or 1 to 999 meters.

- In the submenu for the selected zero distance, rotate the **Rotary Encoder** to move to the preset zero distance.
- Short press the **Rotary Encoder** to begin customizing the zero distance. A blue arrow icon will appear above the selected digit to mark the cursor location. The far-left digit is selected by default.
- Rotate the **Rotary Encoder** to increase or decrease the value of the selected digit, from 0–9.
- Short press the **Rotary Encoder** to switch between the three digits. The blue arrow icon will move to indicate the selected digit.
- Long press the **Rotary Encoder** to save the custom zero distance and return to the zero distance submenu.
- The new zeroing distance appears in the lower-left corner of the screen.



File Management

Manage photo and video files

NOTE: The file management menu item is disabled when Wi-Fi or recoil activated video is turned on in the menu, when a video is recording, and when the rifle scope is connected to a computer via the data cable.

- Long press the **Rotary Encoder** to enter the main menu.
- Rotate the **Rotary Encoder** to select the file management  menu item.



3. Short press the **Rotary Encoder** to enter the file management interface.

4. The file management screen has the following features:

1 Memory: Shows used memory and total memory in GB.

2 Operations Menu:

a. : Manage photo files.

b. : Manage video files.

c. : Manage recoil activated video files.

3 File List: Lists the files for the selected multimedia type, photo, video, or recoil activated video. The selected photo or video is indicated by a blue box around the file name.

4 Thumbnail Window: Shows a thumbnail of the selected photo, video, or recoil activated video.

5 File Management Menu:



a. : View/play the selected file.

b. : Go to the previous page of files.

c. : Go to the next page of files.

d. : Delete the selected file.

e. **Current Page / Page Count:** Shows current page number and total number of pages.

5. Rotate the **Rotary Encoder** to move through the operations menu options and short press the **Rotary Encoder** to select photo , video , or recoil activated video .

6. Rotate the **Rotary Encoder** to move through the file list.

7. Short press the **Rotary Encoder** to select a file. A blue box will appear around the file name and the selected photo or video will appear in the thumbnail window.

8. Rotate the **Rotary Encoder** to move through the file management menu options.

9. Short press the **Rotary Encoder** to select a file management option:

a. Select  to view the selected file full-screen. If viewing a video file, short press the **Rotary Encoder** a second time to play the video, and short press a third time to pause.

b. Select  to go to the next page.

c. Select  to go to the previous page.

d. Select  to delete the file.



10. Short press the **Power**  **Button** to return to the previous level of the file management interface.

11. When the cursor has returned to the Operations Menu, short press the **Power**  **Button** to exit the interface and return to the previous menu.

Advanced Menu

Adjust advanced menu settings

1. Long press the **Rotary Encoder** to enter the main menu.

2. Rotate the **Rotary Encoder** to select the advanced  menu item.

3. Short press the **Rotary Encoder** to enter the submenu.





ADVANCED MENU > VIDEO OUTPUT

Turn video output on / off

The video output function enables connectivity with an external display or recording device via analog video.

1. In the advanced menu, rotate the **Rotary Encoder** to select the video output  menu item.

2. Short press the **Rotary Encoder** to enter the submenu.

3. Rotate the **Rotary Encoder** to toggle video output on / off. The video output status, on  or off , changes in real-time and appears on the right side of the status bar.



4. Long press the **Rotary Encoder** to confirm the selection and return to the home screen.



ADVANCED MENU > BLUETOOTH

Turn Bluetooth on / off

1. In the advanced menu, rotate the **Rotary Encoder** to select the Bluetooth  menu item.
2. Short press the **Rotary Encoder** to enter the submenu.
3. Rotate the **Rotary Encoder** to toggle Bluetooth on / off.

The Bluetooth status, on  or off , changes in real-time and appears on the right side of the status bar.

4. Long press the **Rotary Encoder** to confirm the selection and return to the home screen.



ADVANCED MENU > STATUS AUTO HIDING

Turn status bar auto-hiding on / off

When turned on, this function automatically hides all interface elements, aside from the reticle, for an unobstructed image view.

When auto-hide is turned on, after 15 seconds of inactivity the status bar, compass, and all interface icons will be automatically hidden. Shortcut buttons and the menu are disabled until the entire interface is again displayed. Press any button to show all interface information again.

NOTE: When auto-hide is on and the main menu is open, the menu will hide after 15 seconds of inactivity and the rest of the user interface will hide after an additional 15 seconds.

1. In the advanced menu, rotate the **Rotary Encoder** to select the status auto-hiding  menu item.
2. Short press the **Rotary Encoder** to enter the submenu.
3. Rotate the **Rotary Encoder** to toggle the status bar auto-hiding function on / off. Status bar auto-hiding is off by default.
4. Long press the **Rotary Encoder** to confirm the selection and return to the home screen.



ADVANCED MENU > DATE AND TIME

Set the date and time

1. In the advanced menu, rotate the **Rotary Encoder** to select the date and time  menu item.
2. Short press the **Rotary Encoder** to open the date and time window.
3. The date/time window has the following features:

- 1 **Date/Time Fields:** YYYY-MM-DD (Year, Month, Day) and HH:MM (Hour, Minute).
- 2 **✓ Button:** Save and exit.
- 3 **✗ Button:** Close window without saving.

To set the date and time:

1. The cursor position is indicated by a blue outline around the field or button. The year value is selected by default.
2. Rotate the **Rotary Encoder** to select the correct number for each date/time field, year, month, day, hour, and minute.
3. Short press the **Rotary Encoder** to move through the fields and buttons in the date/time window.
4. Long press the **Rotary Encoder** to save the date/time and return to the home screen; **OR**
5. Rotate the **Rotary Encoder** to move to the **✗ Button**. Short press the **Rotary Encoder** to select it and close the window without saving.

NOTES:

- Alternatively, the date/time may be synchronized with a mobile device using the InfiRay Outdoor App. See **Using the InfiRay Outdoor App** on page 28.
- The time appears on the right side of the status bar.



ADVANCED MENU > COMPASS CALIBRATION

Calibrate the compass

1. In the advanced menu, rotate the **Rotary Encoder** to select the compass calibration  menu item.
2. Short press the **Rotary Encoder** to begin compass calibration.
3. A triaxial coordinate icon prompt will appear on the screen.
4. Follow the icon prompt to rotate the RICO HYBRID at least 360 degrees along each axis, X, Y, and Z. Rotations must be completed within the 15-second calibration time.
5. After 15 seconds, the calibration is finished and the RICO HYBRID will automatically return to the home screen.



3. The interface has the following features:

1 PIP Window:
The Picture in Picture window appears in the lower-left corner.

2 Pixel Cursor:
Cursor appears in the center of the screen in place of the reticle. Move the cursor to the position of the defective pixel.

3 X Button: Move the cursor horizontally.

4 Y Button: Move the cursor vertically.

5 Add Button: Add a defective pixel to the “to be corrected” list.

6 CXL Button: Clear pixels saved in the “to be corrected” list.

7 ✓ Button: Save and exit the interface.

8 x Button: Exit the interface without saving.



ADVANCED MENU > PIXEL DEFECT CORRECTION

Select and correct defective pixels

Defective pixels are pixels that do not change correctly compared to the other image pixels—they are either brighter or darker than surrounding pixels. The RICO HYBRID has a tool that corrects defective pixels on the sensor using its internal software.

1. In the advanced menu, rotate the **Rotary Encoder** to select the pixel defect correction  menu item.
2. Short press the **Rotary Encoder** to enter the defective pixel correction interface.



To select and correct defective pixels:

4. The button cursor position is indicated by a blue highlight at the top of the button. The cursor is located on the **X Button** by default.
5. Short press the **Rotary Encoder** to select the **X Button** and begin moving the pixel cursor along the X-Axis. When selected the entire button becomes highlighted in blue.
6. Move the pixel cursor along the selected axis to the location of the defective pixel:
 - a. Rotate the **Rotary Encoder** clockwise to move in the positive direction: X= Right and Y= Up.
 - b. Rotate the **Rotary Encoder** counterclockwise to move in the negative direction: X= Left and Y= Down.
 - c. Rotate one click to move the reticle in the corresponding direction by 1 pixel. One full rotation (20 clicks) is equivalent to 20 pixels.
7. Short press the **Rotary Encoder** to deselect the X-Axis and the **X Button**.
8. Rotate the **Rotary Encoder** to move to the **Y Button**. Short press the **Rotary Encoder** to select it and begin moving the pixel cursor along the Y-Axis. The entire button becomes highlighted in blue.
9. Rotate the **Rotary Encoder** to move the pixel cursor along the Y-Axis.

- When the pixel cursor is in position over a defective pixel, short press the **Rotary Encoder** to deselect the Y-Axis and the **Y Button**.
- Rotate the **Rotary Encoder** to move to the **Add Button**. Short press the **Rotary Encoder** to select it and add the defective pixel to the “to be corrected” list. The button will briefly be highlighted in blue to indicate that the pixel has been successfully added.
- Repeat the above steps to add any additional defective pixels to the “to be corrected” list.
- To clear the “to be corrected” list and exit the interface, rotate the **Rotary Encoder** to move to the **CXL Button**. Short press the **Rotary Encoder** to select it and clear the “to be corrected” list. The button will briefly be highlighted in blue to indicate that the correction list has been successfully cleared; **OR**
- To correct the saved list of defective pixels, rotate the **Rotary Encoder** to move to the **✓ Button**. Short press the **Rotary Encoder** to select it, correct the saved list of defective pixels, and exit the interface; **OR**
- Rotate the **Rotary Encoder** to move to the **✕ Button**. Short press the **Rotary Encoder** to select it and exit the interface without correcting the saved list of pixels.

NOTE: The PIP window and interface controls will move to the upper-left corner of the screen when the cursor moves into the lower-left corner.

ADVANCED MENU > IMAGE HUE

Set the image hue mode

- In the advanced menu, rotate the **Rotary Encoder** to select the image hue  menu item.
- Short press the **Rotary Encoder** to enter the submenu.
- Rotate the **Rotary Encoder** to move through options, w (warm) and c (cold).
- Long press the **Rotary Encoder** to confirm the selection and return to the home screen.



NOTES:

- Cool mode provides a brighter image and warm mode provides a softer image and reduces eye strain.
- The red hot, iron hot, and rainbow color palettes do not support image hue.

ADVANCED MENU > UNIT

Set the unit of measurement

- In the advanced menu, rotate the **Rotary Encoder** to select the unit  menu item.
- Short press the **Rotary Encoder** to enter the submenu.
- Rotate the **Rotary Encoder** to move through unit options, m (meters) or yd (yards). The selected units appear along with the selected zero distance in the lower-left corner of the screen.
- Long press the **Rotary Encoder** to confirm the selection and return to the home screen.



ADVANCED MENU > FORMATTING

Reformat the internal memory card

This function quickly erases all files saved to the internal memory card.

WARNING: This action cannot be undone. All files saved on the internal memory card will be permanently deleted. Make sure to back up any photos and videos you want to keep to other media storage before reformatting.

- In the advanced menu, rotate the **Rotary Encoder** to select the formatting  menu item.
- Short press the **Rotary Encoder** to enter the submenu.
- Rotate the **Rotary Encoder** to move through options, Yes and No. Yes will reformat the memory card and No will cancel the operation. No is selected by default.
- Short press the **Rotary Encoder** to cancel and return to the settings menu; **OR**
- Rotate the **Rotary Encoder** to move to **Yes** and short press the **Rotary Encoder** to select it and confirm the memory card reformatting.



- a. A loading icon will appear on the screen for about 30 seconds as the memory is reformatted. Do not press any buttons during this time.
- b. The system will return to the home screen automatically.

ADVANCED MENU > FACTORY RESET

Restore factory default settings



1. In the advanced menu, rotate the **Rotary Encoder** to select the factory reset  menu item.
2. Short press the **Rotary Encoder** to enter the submenu.
3. Rotate the **Rotary Encoder** to move through options, Yes and No. Yes will restore factory settings and No will cancel the operation. No is selected by default.
4. Short press the **Rotary Encoder** to cancel and return to the settings menu; **OR**
5. Rotate the **Rotary Encoder** to move to **Yes** and short press the **Rotary Encoder** to select it to confirm the factory reset. Factory settings will be restored and the RICO HYBRID will reboot automatically.



NOTES:

- There is a short pause before the factory restart begins. Do not press any buttons during this time.
- A factory reset cannot be undone.
- The settings listed below will be reset to the factory defaults:

<ul style="list-style-type: none"> • Color Palette: White Hot • Imaging Mode: Clear • Image Brightness: 5 • Image Contrast: 5 • Calibration/NUC Mode: Automatic • Target Distance: 0000m • Reticle Type: 1 • Reticle Color: Black • Digital Zoom: 1.0× • Wi-Fi: Off • Compass: Off • Microphone: Off 	<ul style="list-style-type: none"> • Standby: Off • Photo Settings: Single-shot • Recoil Activated Video: Off • Video Output: Off • Bluetooth: Off • Status Bar Auto-Hide: Off • Image Hue: Warm • Unit: Meters • ROI: Off • PIP: Off • Wi-Fi SSID: Hybrid_HYH75W_XXXX • Wi-Fi Password: 12345678
--	---

ADVANCED MENU > INFO

Show device information

1. In the advanced menu, rotate the **Rotary Encoder** to select the info  menu item.
2. Short press the **Rotary Encoder** to enter the submenu.
3. The info submenu will display the following information about the RICO HYBRID: the product model, PN and SN numbers, FGPA, and HW and SOC versions.
4. Long press the **Power**  **Button** to return to the home screen.



29. BASIC INSPECTION

It is recommended to carry out a technical inspection before each use. Please check the following:

- The rifle scope appearance: there should be no cracks in the body or visible damage.
- The condition of the objective lens and eyepiece: there should be no cracks, greasy spots, dirt, or other deposits on the lens.
- The internal rechargeable battery pack should be fully charged.
- The control buttons should be in working order.

30. BASIC MAINTENANCE

Always replace the objective lens cap **(1)** after use to avoid damaging or scratching the lens. Never touch the lens directly; oil from your skin can damage the lens coating and surface.

Basic maintenance should be carried out at least twice a year and includes the following steps:

- Wipe the surface of the external metal and plastic components with a clean, dry cotton cloth. Do not use chemical, corrosive, or abrasive cleaners. Canned air may also be used to clean the external components.
- Clean the electric contacts and battery slots on the rifle scope using a non-greasy organic solvent.
- Check the lens and eyepiece. If necessary, remove any dirt or sand from the optics; a non-contact cleaning method is preferred.

- Cleaning the exterior of the lens should only be done with the included microfiber lens cloth or a similar product. Only clean the lens when it is visibly soiled. Frequent wiping or cleaning can degrade the anti-reflective lens coating.

31. WARRANTY

At iRayUSA we’re first and foremost hunters and users of our products and we understand that failure isn’t an option. We also understand that having to wait extended periods for repair isn’t something that a customer should have to put up with when something does go wrong. During your published warranty period, iRayUSA will repair or replace, at its discretion, any optic that becomes defective during normal use. Additionally, if we cannot fix your optic in less than one week, we will offer to replace it with a replacement product in like or better condition. If you would rather wait for your specific optic to be repaired, we can handle that too.

We know you’ve never seen this from a thermal manufacturer and neither have we; that’s why we started iRayUSA.

Our warranty follows the product and is not tied to the original owner. The warranty period is tied to the date of sale to the dealer. This warranty only covers normal use and does not cover cosmetic damage, normal wear, intentional damage, theft, loss, any act of God, or a condition caused by use other than intended. Any product that is modified, opened, or tampered with will void any warranty coverage. Any serial number damage or alteration on the product will be considered a modification. Be sure to register your RICO HYBRID rifle scope at irayusa.com/register.

To return a product for repair:

1. Go to irayusa.com/warranty and click the **Request an RMA button** to request an RMA number. Returns will not be accepted without an RMA.
2. The customer is responsible for shipping the product to iRayUSA, per the instructions included with the RMA. iRayUSA will return the product at no cost.

WARRANTY NOTES:

- The one-week timeline starts from the time of receipt of the product at iRayUSA.
- iRayUSA is not liable for any damages or loss incurred when shipping to iRayUSA.
- This warranty gives you specific legal rights, and you may also have other rights which vary from state to state.

Please give us a call at **800-769-7125**, visit irayusa.com/warranty, or email info@irayusa.com with any questions.

32. GENERAL TROUBLESHOOTING

The troubleshooting table on the next page lists issues that may occur when operating the RICO HYBRID. Carry out the recommended troubleshooting steps in the order shown in the table. Please contact iRayUSA at 800-769-7125 or irayusa.com/support or an authorized vendor for assistance before attempting to perform any modifications or repairs beyond the scope of the troubleshooting procedures in this manual. Unauthorized repairs or modifications will void your warranty.

33. NOTES

ISSUE	POSSIBLE CAUSES
The RICO HYBRID will not turn on.	The IBP-1H battery pack is very low or has completely discharged.
The RICO HYBRID can not connect to a computer or external power supply.	External power supply has completely discharged.
	Computer is turned off.
	Data cable is damaged.
The RICO HYBRID can not connect to the mobile device (smartphone or tablet).	Wi-Fi is not turned on.
	Wrong Wi-Fi password entered.
	Too many Wi-Fi signals near the RICO HYBRID.
Wi-Fi signal is lost or interrupted.	Smartphone or tablet is out of range of a strong Wi-Fi signal, or there are obstacles between the RICO HYBRID and the mobile device.
The image is fuzzy, not clear, not balanced, or has artifacts.	Non-uniformity correction is required.
The image is too dark.	Display brightness level is too low.
The GUI is clear, but the image is fuzzy.	The lens is not focused.
	There is dust on the interior or exterior optical surfaces of the lens.
	There is condensation on the interior or exterior optical surfaces of the lens.
The aiming reticle shifts after firing rounds.	The RICO HYBRID is not mounted securely or the mount is not secured on the RICO HYBRID.
The image of the object being observed is missing.	Looking through glass.
The RICO HYBRID will not focus.	Image settings are not optimal for the current environmental conditions or the object being observed.
Image quality is too low or the detection range is reduced.	These issues may occur due to the weather conditions, such as snow, rain, humidity, and fog.
When the RICO HYBRID is used in low-temperature conditions, the image quality of the surroundings is worse than in warm-temperature conditions.	Environmental conditions.

TROUBLESHOOTING STEPS
Charge the battery pack.
Check the external power supply and charge it if necessary.
Power on the computer.
Replace the data cable.
Turn on the Wi-Fi in the main menu. See Main Menu > Wi-Fi on page 34.
On the mobile device, go to Settings > Wi-Fi and enter the correct password. The default password is 12345678. See Main Menu > Wi-Fi on page 34.
Move the RICO HYBRID and mobile device to an area with no or fewer Wi-Fi signals.
<ul style="list-style-type: none"> Try again when the Wi-Fi signal is stable. Relocate the RICO HYBRID closer to the Wi-Fi signal.
Perform a non-uniformity correction. See Non-uniformity Correction on page 23 and See Using the Quick Menu on page 19.
Adjust the display brightness in the quick menu. See Using the Quick Menu on page 19.
<ul style="list-style-type: none"> Adjust the focus on the target by rotating the objective focus knob (2). Adjust the image sharpness in the quick menu. See Using the Quick Menu on page 19.
<ul style="list-style-type: none"> Wipe the external optical surface with the included microfiber lens cloth.
<ul style="list-style-type: none"> Wipe the external optical surface with the included microfiber lens cloth. Allow the RICO HYBRID to dry by leaving it in a warm, dry environment for at least 4 hours.
<ul style="list-style-type: none"> Check that the RICO HYBRID has been securely mounted. Make sure you are using the same brand, type, and weight of the bullets as when the RICO HYBRID and weapon were initially zeroed. If the RICO HYBRID was zeroed in different environmental conditions, a slight shift of the zero is possible.
Remove any glass windows from the field of view.
<ul style="list-style-type: none"> Check the external surface of the objective lens and eyepiece and, where necessary, wipe away any dust, condensation, frost, etc. In cold weather, you can use special anti-fogging coatings, such as those made for corrective glasses. Adjust the focus on the target by rotating the objective focus knob (2). Adjust the image sharpness in the quick menu. See Using the Quick Menu on page 19. Adjust the image and device settings. See Quick Start Guide on page 8.
Short press the Palette Button to set the imaging mode to fog mode.
In warm-temperature conditions, objects being observed (surroundings and background) heat up differently because of thermal conductivity, thereby generating a high-temperature contrast. Accordingly, image quality produced by the rifle scope will be higher. In low-temperature conditions, the background will cool down to roughly the same temperature, and thus the temperature contrast is substantially reduced and image detail can go down as there is less contrast in the scene. This is a normal function of a thermal imager and is no indicator of actual detector performance.



2601 State Hwy 121,
Building 3, Suite 306
Lewisville, TX 75056
800-769-7125
682-499-0047
info@irayusa.com