

# **Pegasus**

## **User's Manual**











# Foreword

## General

This manual introduces the functions and operations of Pegasus (hereinafter referred to as "the Camera"). Read carefully before using the device, and keep the manual safe for future reference.

## Safety Instructions

The following signal words might appear in the manual.

Signal Words	Meaning
 <b>DANGER</b>	Indicates a high potential hazard which, if not avoided, will result in death or serious injury.
 <b>WARNING</b>	Indicates a medium or low potential hazard which, if not avoided, could result in slight or moderate injury.
 <b>CAUTION</b>	Indicates a potential risk which, if not avoided, could result in property damage, data loss, reductions in performance, or unpredictable results.
 <b>ESD</b>	Electrostatic Sensitive Devices. Indicates a device that is sensitive to electrostatic discharge.
 <b>ELECTRIC SHOCK</b>	Indicates dangerous high voltage. Take care to avoid coming into contact with electricity.
 <b>LASER RADIATION</b>	Indicates a laser radiation hazard. Take care to avoid exposure to a laser beam.
 <b>TIPS</b>	Provides methods to help you solve a problem or save time.
 <b>NOTE</b>	Provides additional information as a supplement to the text.

## Revision History

Version	Revision Content	Release Time
V1.0.2	Updated the camera figures.	October 2024
V1.0.1	Updated "Charging".	March 2024
V1.0.0	First release.	December 2023

## Privacy Protection Notice

As the device user or data controller, you might collect the personal data of others such as their face, fingerprints, and license plate number. You need to be in compliance with your local privacy protection laws and regulations to protect the legitimate rights and interests of other people by implementing measures which include but are not limited: Providing clear and visible identification to inform people of the existence of the surveillance area and provide required contact information.

## About the Manual

- The manual is for reference only. Slight differences might be found between the manual and the

product.

- We are not liable for losses incurred due to operating the product in ways that are not in compliance with the manual.
- The manual will be updated according to the latest laws and regulations of related jurisdictions. For detailed information, see the paper user's manual, use our CD-ROM, scan the QR code or visit our official website. The manual is for reference only. Slight differences might be found between the electronic version and the paper version.
- All designs and software are subject to change without prior written notice. Product updates might result in some differences appearing between the actual product and the manual. Please contact customer service for the latest program and supplementary documentation.
- There might be errors in the print or deviations in the description of the functions, operations and technical data. If there is any doubt or dispute, we reserve the right of final explanation.
- Upgrade the reader software or try other mainstream reader software if the manual (in PDF format) cannot be opened.
- All trademarks, registered trademarks and company names in the manual are properties of their respective owners.
- Please visit our website, contact the supplier or customer service if any problems occur while using the device.
- If there is any uncertainty or controversy, we reserve the right of final explanation.

# Important Safeguards and Warnings

This section introduces content covering the proper handling of the device, hazard prevention, and prevention of property damage. Read carefully before using the device, and comply with the guidelines when using it.

## Transportation Requirements



- Transport the Camera within the allowed humidity and temperature conditions.
- Do not fall, squeeze, violently vibrate or immerse the device in liquid when transporting. Gently pick and place the Camera when moving, prevent the internal equipment becoming damaged or cable connection becoming loose.
- Do not transport the Camera without package. Use the factory default package or material of equal quality to pack the Camera when transporting it, otherwise the Camera can become easily damaged.

## Storage Requirements



- Store the Camera within the allowed humidity and temperature conditions.
- Do not place the device in a humid, dusty or extremely hot or cold site that has strong electromagnetic radiation or unstable illumination.
- Do not squeeze, violently vibrate or immerse the device in liquid.
- Do not mechanically vibrate or crash when storing.
- Store the Camera in a ventilated place that has no strong electromagnetic radiation.
- For long-term storage of the battery, make sure that it is fully charged every half year to ensure the battery quality. Otherwise, damage may occur.

## Operation Requirements



- Prevent liquid from flowing into the Camera to avoid damage to the internal components.
- Do not stuff foreign materials into the Camera to prevent a short circuit which could result in the Camera being damaged or people becoming injured.
- Do not expose the device to high electromagnetic radiation or dusty environments.
- Do not aim the lens at the sun or any other bright light.
- Improper use or replacement of the battery may result in explosion hazard.
- Do not charge other battery types with the supplied charger. Confirm there is no flammable material within 2 m of the charger during charging.
- Make sure that the plug is properly connected to the power socket.
- Do not connect multiple devices to one power adapter, to avoid over-heating or fire hazards caused by overload.
- If smoke, odor, or noise arises from the device, immediately turn off the power, unplug the power cable, and contact the service center.



- Do not dismantle the Camera. The internal components can only be repaired by a qualified professional. Dismantling it without professional assistance might cause water seeping in or might result in the Camera producing poor quality images.
- Operating temperature:  $-30\text{ }^{\circ}\text{C}$  to  $+55\text{ }^{\circ}\text{C}$  ( $-22\text{ }^{\circ}\text{F}$  to  $+121\text{ }^{\circ}\text{F}$ ), and the operating humidity shall be 95% or less.

## Maintenance and Repair Requirements



### DANGER

- Prevent liquid from flowing into the Camera to avoid damage to the internal components. In case the liquid enters the Camera, immediately stop using the Camera, cut off the power, and disconnect all the cables, and then contact your local customer service center.
- Use the accessories regulated by the manufacturer. The Camera should be maintained by qualified professionals.
- Make sure to cut off the power before cleaning the Camera, to prevent electric shock.



### WARNING

If the Camera malfunctions, contact your local customer service center. Do not dismantle the Camera.



- Clean the Camera body with a piece of soft dry cloth. For any dirt that is hard to remove, pick up a piece of clean and soft cloth, dip it into a little neutral detergent and gently wipe the dust away. After that, wipe away all the remaining liquid on the Camera with another dry cloth. Never use volatile solvents such as alcohol, benzene and thinner, or cleaners that are strong and abrasive. Otherwise, the Camera's surface coating will be damaged and its working performance will be encumbered.
- Save the factory package of the Camera. When the Camera malfunctions, pack the Camera with the factory package and send to the dealer.

# Table of Contents

Foreword .....	I
Important Safeguards and Warnings.....	III
1 Product Introduction .....	1
2 Structure .....	2
2.1 Packing List.....	2
2.2 Device Description.....	2
3 Basic Operation .....	5
3.1 Starting and Shutdown .....	5
3.1.1 Manual Starting and Shutdown .....	5
3.1.2 Auto Shutdown.....	5
3.2 Image Adjustment.....	5
3.2.1 Adjusting Diopter.....	5
3.2.2 Adjusting Focus.....	6
3.2.3 Setting Color Palettes.....	6
3.2.4 Setting Digital Zoom.....	8
3.2.5 Setting Brightness.....	9
3.2.6 Setting Contrast .....	9
3.2.7 Setting Sharpness.....	9
3.2.8 Setting Status Bar.....	9
3.3 Configuring the Camera.....	10
3.3.1 Menu Description .....	10
3.3.2 Brief Menu .....	10
3.3.3 Standard Menu .....	11
3.3.3.1 Setting Forest Mode.....	11
3.3.3.2 Setting Zeroing Profile.....	11
3.3.3.3 Setting Zeroing .....	12
3.3.3.4 Setting PIP .....	13
3.3.3.5 Setting Hot Point.....	13
3.3.3.6 Setting Wi-Fi Connection .....	13
3.3.3.7 Setting Ranging Mode.....	14
3.3.3.8 Function Settings.....	15
3.3.3.9 Setting FFC Mode.....	16
3.3.3.10 Setting DPC .....	16
3.3.3.11 System Settings.....	16
3.4 Video and Snapshot .....	17

<b>3.4.1 Recording Videos</b> .....	17
<b>3.4.1.1 Auto Recording</b> .....	17
<b>3.4.1.2 Recording Videos</b> .....	17
<b>3.4.2 Capturing Images</b> .....	18
<b>3.4.3 Exporting File</b> .....	18
<b>3.5 Power Supply</b> .....	18
<b>3.5.1 Installing the Battery</b> .....	18
<b>3.5.2 Charging</b> .....	18
<b>4 System Update</b> .....	20
<b>4.1 Upgrading Manually</b> .....	20
<b>4.2 Upgrading through App</b> .....	20
<b>Appendix 1 Compliance Notice</b> .....	21

# 1 Product Introduction

The thermal monocular camera captures sharp thermal imaging at a fast frame rate for smooth, impeccable vision on running targets and from moving vehicles. Designed to increase situational awareness at any time of day, the camera can detect humans, animals, and objects in complete darkness, haze, or through glaring light, equipping law enforcement professionals, hunters, and outdoor enthusiasts with reliable thermal imaging in tough conditions. It is widely used in outdoor scenarios for hunting, animal observation, and more.



# 2 Structure

## 2.1 Packing List

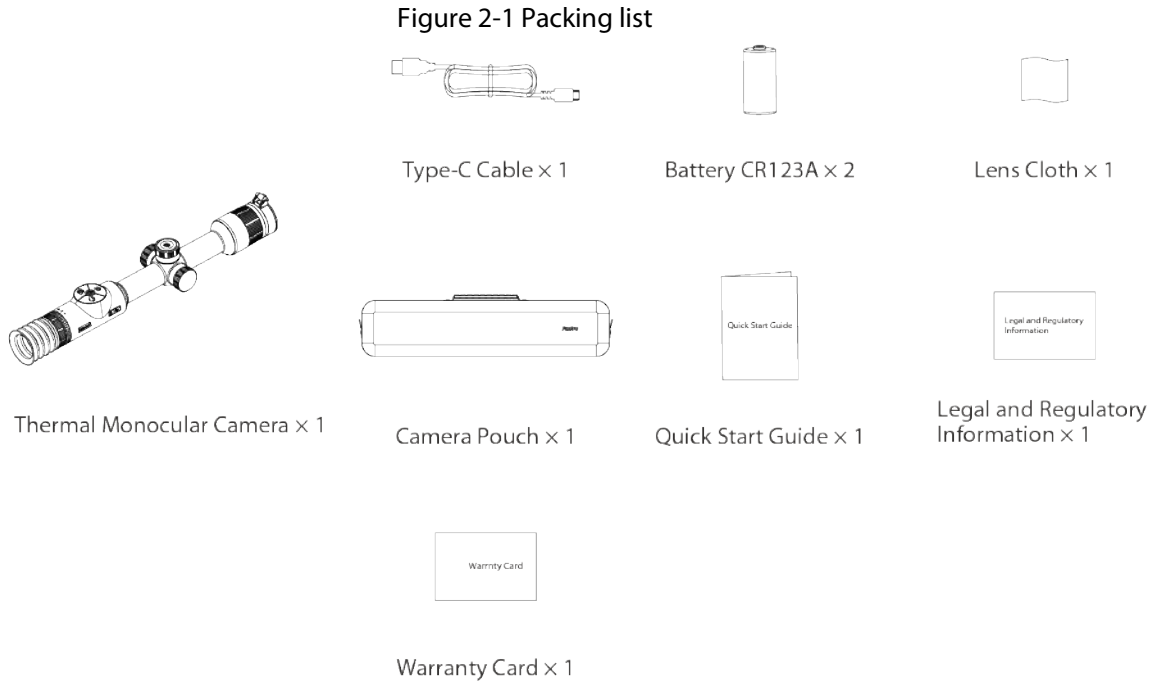

## 2.2 Device Description

Figure 2-2 Button description (f35)

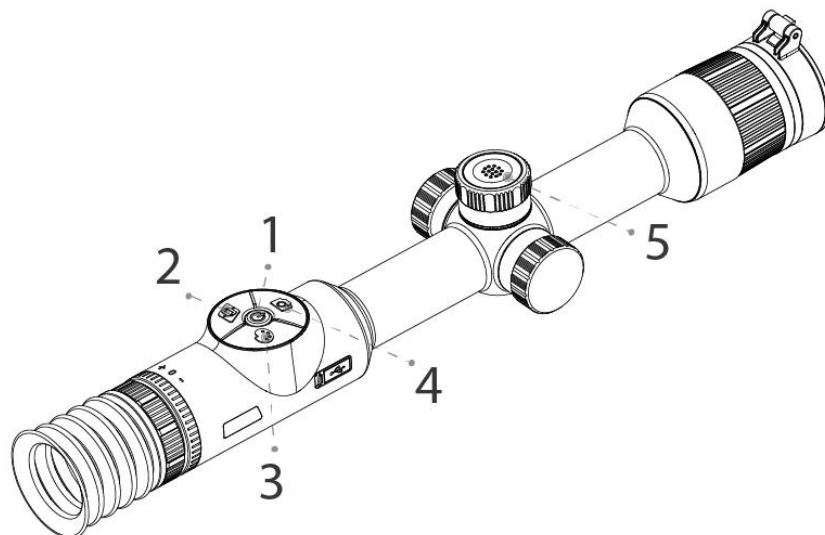

Figure 2-3 Button description (f50)

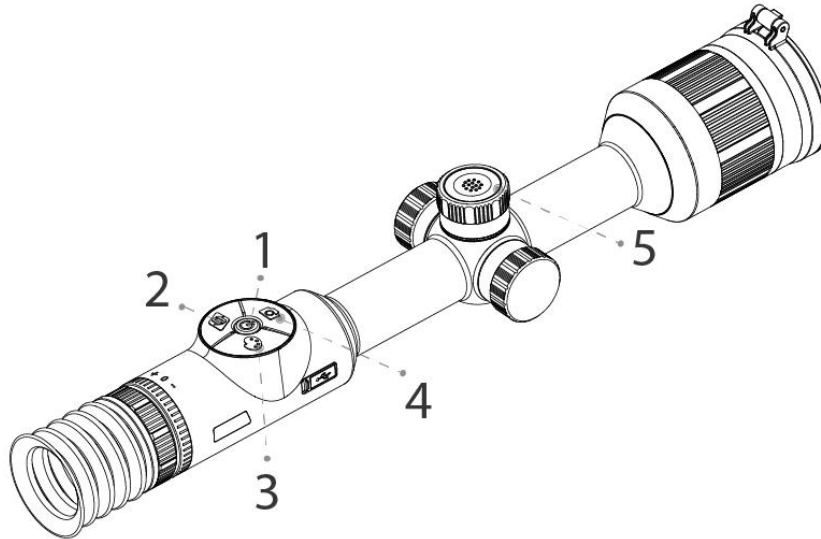

Table 2-1 Button description

No.	Name	Description
1	Power button	<ul style="list-style-type: none"> <li>• Press and hold to start or shut down the Camera.</li> <li>• Double-press to enter the sleep mode.</li> </ul>
2	Zeroing button	Press to select the zeroing profile.
3	FFC/Color Palettes button	<ul style="list-style-type: none"> <li>• Press and hold to do the flat-field calibration for the image.</li> <li>• Press to select the color palettes.</li> </ul>
4	Capture button	<ul style="list-style-type: none"> <li>• Press and hold to record videos.</li> <li>• Press to capture images.</li> </ul>
5	Menu/Zoom button	<ul style="list-style-type: none"> <li>• Press and hold to go to the standard menu.</li> <li>• Press to go to the brief menu.</li> <li>• Rotate the button for digital zoom.</li> <li>• Double-press to do the flat-field calibration for the image.</li> </ul>

Figure 2-4 Component description (f35)

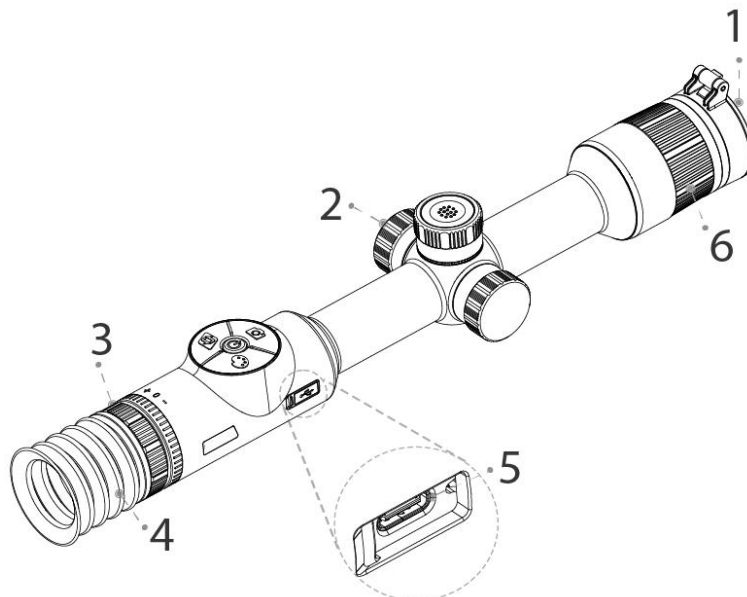

Figure 2-5 Component description (f50)

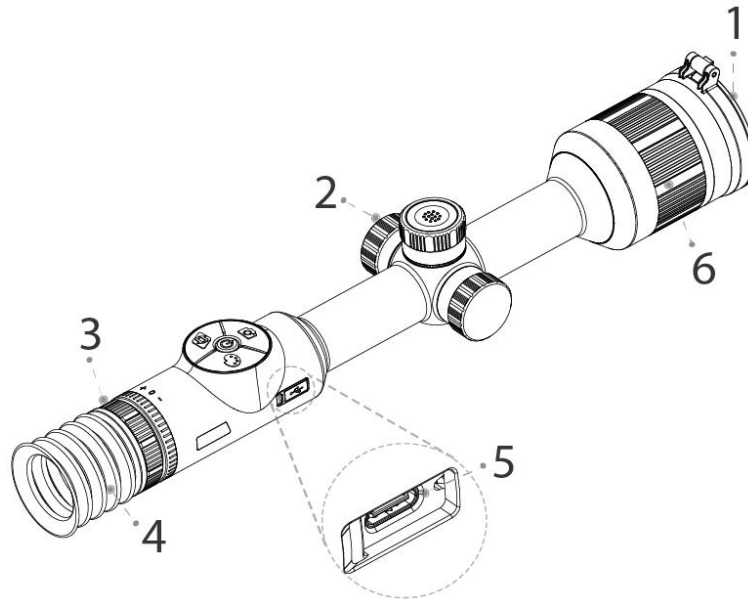



Table 2-2 Component description

No.	Name	Description
1	Protective cover	Dust prevention. Close the cover when not using the Camera.
2	Battery compartment	The place for holding the battery.
3	Diopter adjustment rotary knob	Adjust according to your eyesight.
4	Eyeshade	Protects the eyes from glare.
5	Type-C port	<ul style="list-style-type: none"> <li>Connects to a data cable for charging.</li> <li>Connects to the Camera to a computer for exporting files.</li> </ul>
6	Adjustable lens	Manually rotate the focusing ring to adjust the focus for a clear image.

# 3 Basic Operation





## 3.1 Starting and Shutdown

### 3.1.1 Manual Starting and Shutdown

Press and hold  to start or shut down the Camera; double-press  to suspend the Camera.



After starting the Camera, remove the protective cover of the lens.

- When the Camera is off, press and hold  to start it.
- When the Camera is on, press and hold  to shut down it.
- When the Camera is on, double-press  to suspend the Camera.
- When the Camera is in suspend mode, press  to weak up it.

### 3.1.2 Auto Shutdown

Step 1 Press and hold  to go to the standard menu.

Step 2 Rotate  to select .

Step 3 Press  to go to the **System Setting** configuration screen.

Step 4 Rotate  to select .

Step 5 Press  to set the auto shutdown time.

If there is no operation in the configured time, the Camera will automatically shut down.

## 3.2 Image Adjustment

### 3.2.1 Adjusting Diopter

To get clear images, rotate the diopter knob to fit your eyesight.



For the first-time use, adjust the diopter before configuring the functions.

Step 1 Aim the lens at the target, and then make your eyes close to the eyeshade.

Step 2 Adjust clockwise or counterclockwise the eyepiece to your eyesight.

Figure 3-1 Adjust diopter

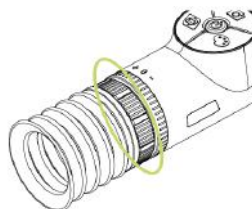

## 3.2.2 Adjusting Focus

Manually rotate the focusing ring to adjust the focus for a clear image.

**Step 1** Aim the thermal lens to the target.

**Step 2** Adjust clockwise or counterclockwise the focusing ring until the view is clear.



During the adjustment, do not touch the lens to avoid smudging it; otherwise it may affect the image quality.

Figure 3-2 Adjust focusing (f35)

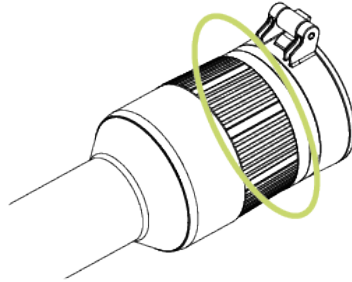
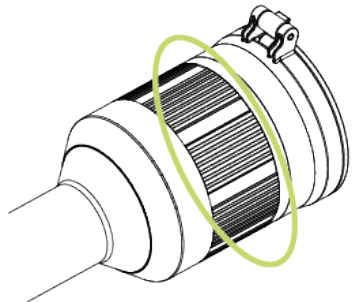



Figure 3-3 Adjust focusing (f50)



## 3.2.3 Setting Color Palettes

Select the color palettes, which adds color to the thermal image and uses color to indicate the temperature.

**Step 1** On the viewing screen, press  to select the color palettes.

- White Hot: The objects with high temperature are white. The higher the temperature, the brighter the color.
- Sepia: The objects with high temperature are amber. The higher the temperature, the brighter the color.
- Green Hot: The objects with high temperature are green. The higher the temperature, the brighter the color.
- Alarm: The objects with high temperature are red. The objects can stand out.
- Iron Red: The objects with high temperature are red. The higher the temperature, the brighter the color.
- Black Hot: The objects with high temperature are black. The higher the temperature, the darker the color.

Figure 3-4 White hot



Figure 3-5 Sepia



Figure 3-6 Green hot



Figure 3-7 Alarm



Figure 3-8 Iron red



Figure 3-9 Black hot



### 3.2.4 Setting Digital Zoom

Digital zoom helps to zoom in the image.

On the viewing screen, rotate  to do digital zoom, and the image changes.

### 3.2.5 Setting Brightness

Adjusts the overall screen brightness. The higher the level is, the brighter the screen will be.

Step 1 Press  to go to the brief menu.



You can also press and hold  to go to the standard menu.

Step 2 Rotate  to select .

Step 3 Press  to select the brightness level. The higher the level is, the brighter the screen will be.

### 3.2.6 Setting Contrast

Adjusts the contrast of the picture. The higher the level is, the more the contrast will be between bright and dark areas.

Step 1 Press  to go to the brief menu.



You can also press and hold  to go to the standard menu.

Step 2 Rotate  to select .

Step 3 Press  to select the contrast level. The higher the level is, the brighter the screen will be.

### 3.2.7 Setting Sharpness

Adjusts the sharpness of picture edges. The higher the level is, the clearer the picture edges will be.

Step 1 Press and hold  to go to the standard menu.

Step 2 Rotate  to select .

Step 3 Press  to select the sharpness level. The higher the level is, the brighter the screen will be.





### 3.2.8 Setting Status Bar

Step 1 Press hold  to go to the standard menu.



Step 2 Rotate  to select  > **OSD**.

Step 3 Press  to enable OSD, and the status bar is displayed.

Table 3-1 Description of status bar

Icon	Name	Description
	Wi-Fi	<ul style="list-style-type: none"><li>: The Wi-Fi function is disabled.</li><li>: The Wi-Fi function is enabled.</li></ul>
	Digital zoom	Supports 1x, 2x, 4x and 8x digital zoom. The number might different depending on models.







Icon	Name	Description
	Battery level (built-in)	Displays the battery (built-in) level in real time.
	Battery level (dry cell)	Displays the battery (dry cell) level in real time.

## 3.3 Configuring the Camera

### 3.3.1 Menu Description

When the Camera is on, press and hold  to go to the standard menu. Functions of all buttons are as follows.

- Rotate  to move upward or downward the cursor.
- Press  to set the parameters and confirm.
- Press and hold  or press  to exit.

### 3.3.2 Brief Menu

Press  to go to the brief menu. You can set color palettes, brightness, contrast, forest mode, and select the zeroing profile.

Step 1 Press  to go to the brief menu.

Figure 3-10 Brief menu







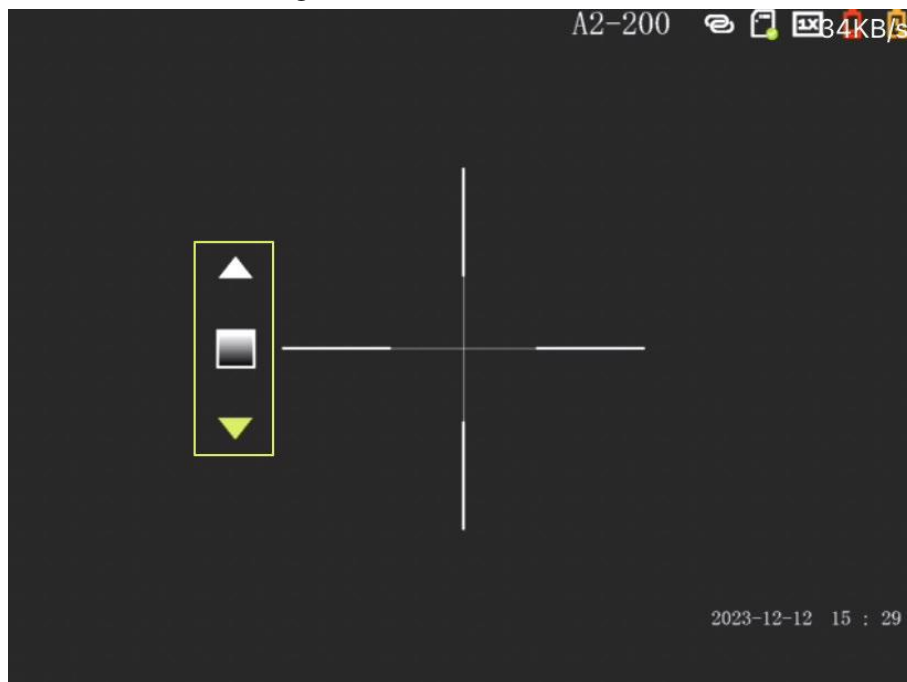









Step 2 Rotate  to select the parameters to be configured.

Table 3-2 Brief menu

Parameters	Description
Color palettes 	Press  to select the color palettes, which adds color to the thermal image and uses color to indicate the temperature.
Zeroing profile 	Press  to select the zeroing profile.  <ul style="list-style-type: none"> <li>• The camera supports multiple zeroing profiles.</li> <li>• Before setting zeroing profile, make sure that you have configured zeroing. For details, see "3.3.3.3 Setting Zeroing".</li> </ul>
Forest mode 	Press  to enable or disable the forest mode. <ul style="list-style-type: none"> <li>• : Forest mode. Stands out the targets with high temperature, which makes it easier to find out the targets.</li> <li>• : Standard mode. It is used for daily observation.</li> </ul>
Contrast 	Press  to select the contrast level.
Brightness 	Press  to select the brightness level.

Step 3 Press and hold  to exit and save the configuration.

## 3.3.3 Standard Menu

### 3.3.3.1 Setting Forest Mode

Step 1 Press and hold  to go to the standard menu.

Step 2 Rotate  to select .

Step 3 Press  to enable or disable the forest mode.

- ON: Forest mode. Stands out the targets with high temperature, which makes it easier to find out the targets.
- OFF: Standard mode. Used for daily observation.

### 3.3.3.2 Setting Zeroing Profile

#### Prerequisites

Before setting zeroing profile, make sure that you have configured zeroing in **Zeroing**. For details, see "3.3.3.3 Setting Zeroing".

#### Procedure

Step 1 Press and hold  to go to the standard menu.

Step 2 Rotate  to select .

Step 3 Press  to select the zeroing profile as needed.



The camera supports multiple zeroing profiles.

### 3.3.3.3 Setting Zeroing

#### Prerequisites

Before setting zeroing, make sure that you have selected the zeroing group in **Zeroing Profile**. For details, see "3.3.3.2 Setting Zeroing Profile".





#### Procedure

Step 1 Press and hold  to go to the standard menu.

Step 2 Rotate  to select .





Step 3 Press  to go to the zeroing configuration screen.

Step 4 Rotate  to select the parameters to be configured.



- Reticle No. (): Press  to select a number as the reticle number.
- Type (): Press  to select the reticle type.



The Camera supports multiple reticles.

- Color (): Press  select the reticle color from **White, Red, Green**.
- Distance (): Press  to select the distance between the target and the Camera.

Step 5 Adjust the reticle.

When the cursor is offset, select , and then press  to go to the reticle adjustment screen.











- 1) Set the distance. Press , and the **Distance Setting** screen is displayed.
  - Rotate  to set the value.
  - Press  to switch the digits.
  - Press and hold  to exit and save the configuration.
- 2) After shooting at the target, select  and then press  to freeze the image.
- 3) Select , and then press  to select X-axis and Y-axis.
- 4) Rotate  to move the reticle to the shooting point.
- 5) Select , and then press  to save the configuration.

Figure 3-11 Adjust the reticle



### 3.3.3.4 Setting PIP

After enabling PIP, the target with the reticle can be magnified in the OSD image, which offers a closer view of the target with the whole visual scene.

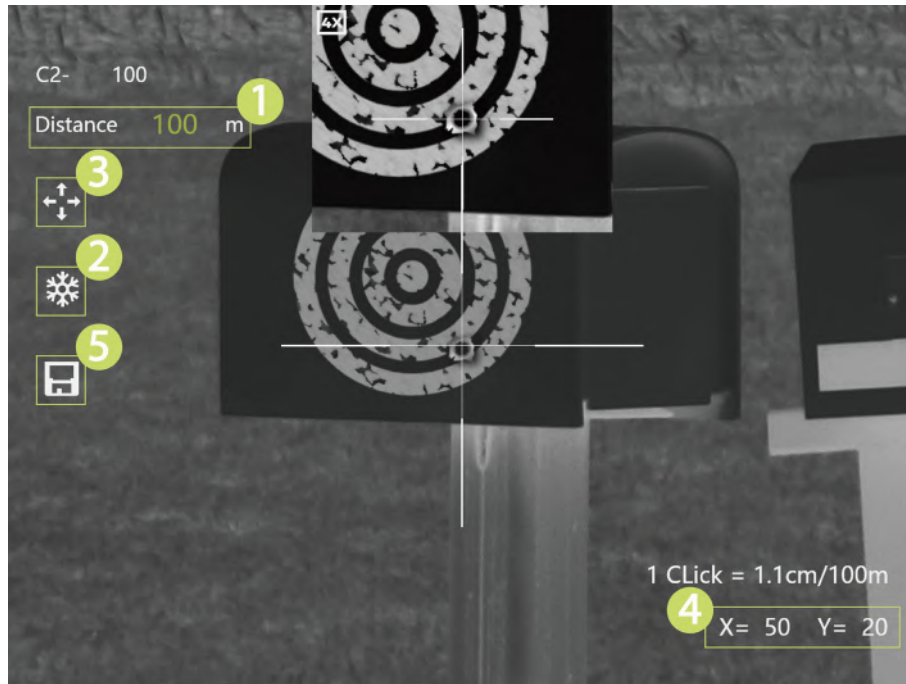
**Step 1** Press and hold to go to the standard menu.

**Step 2** Rotate to select .

**Step 3** Press to enable or disable PIP.

- On: An OSD image is displayed on the screen, and the target with the reticle can be magnified in the OSD image.
- Off: Disable the PIP.

### 3.3.3.5 Setting Hot Point

Tracks the point with the highest temperature in real time.

**Step 1** Press and hold to go to the standard menu.

**Step 2** Rotate to select .

**Step 3** Press to enable or disable the hot point.

After enabling the hot point, the hot point icon will automatically locate at the points with the highest temperature in the image.

### 3.3.3.6 Setting Wi-Fi Connection

After enabling Wi-Fi connection, you can connect your phone to the hotspot of the Camera, and then access the Camera with the app.

The frequency bands and modes and the nominal limits of transmitted power (radiated and/or conducted) applicable to this radio device are the following:

Wi-Fi 2.4 GHz (2.4 GHz to 2.4835 GHz)	20 dBm
---------------------------------------	--------



Some cameras will automatically disable the Wi-Fi function when the battery level is lower than 15%.

Step 1 Scan the QR code with your smart phone to install the app.

Figure 3-12 QR code



Step 2 Press and hold  to go to the standard menu.

Step 3 Rotate  to select .

Step 4 Press  to enable the Wi-Fi function.

- Wi-Fi name: Model number + serial number.
- Wi-Fi password: 12345678.

Step 5 Log in to the app.

Add access devices according to the prompt.

### 3.3.3.7 Setting Ranging Mode

After setting the ranging mode, the Camera can measure the range towards targets.



To guarantee the measurement accuracy, keep your hand steady when measuring the range.

Step 1 Press and hold  to go to the standard menu.

Step 2 Rotate  to select .

Step 3 Press  to enter the ranging mode.

Step 4 Press  to move the green lines to the top and bottom of the target to get the distance between the target and the Camera.

Use the following figure as an example:

- If the target is a wolf, it is 30 m away from Camera.
- If the target is a rabbit, it is 11 m away from Camera.
- If the target is a wild boar, it is 33 m away from Camera.
- If the target is a deer, it is 48 m away from Camera.

Figure 3-13 Ranging Mode

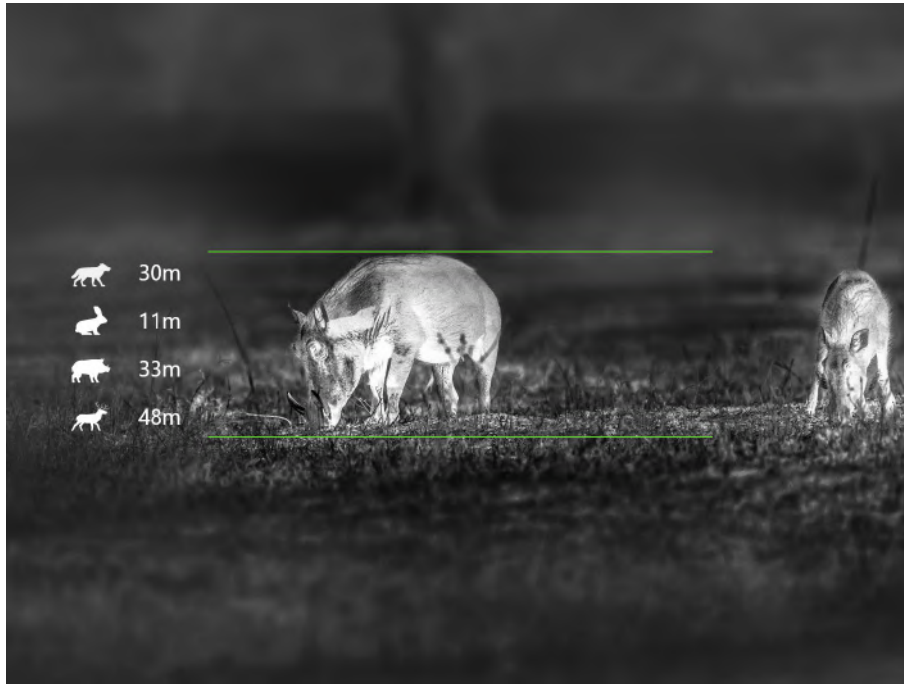



### 3.3.3.8 Function Settings

- Step 1** Press and hold to go to the standard menu.
- Step 2** Rotate to select .
- Step 3** Press to go to the **Function** screen..
- Step 4** Rotate to select function to be configured.

Table 3-3 Function settings

Function	Description
Compass	Press  enable the Compass function, and the location information is displayed on the screen.
Compass Init	Press  to initialize the location. In 15 s, rotate the scope along the three axes indicated by the icon, with each axis rotating at least 360°. After 15 s, the calibration completes automatically and exit to the main menu.
Burning Warning	Press  to enable the burning warning function. When the lens is in the risk of burning, a note will be displayed on the screen and the shutter will be off automatically.
Logo	Press  to enable logo display, and the logo will be display on the left lower corner of the screen.
OSD	Press  to enable OSD display, and the status bar is displayed.
FFC Mode	Press  to select the FFC (Flat-Field Calibration) mode from <b>Auto</b> and <b>Manual</b> . For details, see "3.3.3.9 Setting FFC Mode".
DPC	Press  to enable DPC (Defective Pixels Correction), and you can correct the defective pixels in the image. For details, see "3.3.3.10 Setting DPC".

Function	Description
Auto REC 	When the impact sensor of the Camera detects impact, it will automatically record the video, recording the wonderful moment of hunting. For details, see "3.4.1.1 Auto Recording".
MIC 	Press  to enable or disable the microphone. <ul style="list-style-type: none"> <li>• On: The videos are recorded with sound.</li> <li>• Off: The videos are recorded without sound.</li> </ul>



### 3.3.3.9 Setting FFC Mode

With FFC (Flat-Field Calibration), the thermal image can be optimized, and you can easily find out temperature changes.

Step 1 Press and hold  to go to the standard menu.

Step 2 Rotate  to select  > .

Step 3 Press  to go to the FFC mode.

- Auto: The camera calibrates image automatically every certain period.
- Manual: On the viewing screen, double-press  or press and hold  to manually calibrate the image.

### 3.3.3.10 Setting DPC





After enabling DPC (Defective Pixels Correction), you can correct the defective pixels in the image.

Step 1 Press and hold  to go to the standard menu.

Step 2 Rotate  to select  > .

Step 3 Press  to go to the FFC mode configuration screen.

Step 4 Rotate  to select the FFC mode.

- Auto: The Camera automatically corrects the defective pixels in the image.
  1. Press  to confirm.  
The camera calibrates image automatically.
- Manual: The Camera automatically corrects the defective pixels in the image.
  1. Press  to select X-axis and Y-axis.
  2. Rotate  to make the cursor coincide with the defective pixel.
  3. Press and hold  to save the configuration.



The center of the cursor is the position of the defective pixel.

- Restore: The DPC configuration is restored to the primary state.

### 3.3.3.11 System Settings

Step 1 Press and hold  to go to the standard menu.

Step 2 Rotate  to select .

Step 3 Press  to go to the **System Setting** screen..













Step 4 Rotate  to select the parameter to be configured.

Table 3-4 System settings

Parameter	Description
Auto Standby	Press  to set the auto standby time. The Camera will automatically standby in the configured time.
Auto Shutdown	Press  to set the auto shutdown time. For details, see "3.1.2 Auto Shutdown".
USB Mode	Press  to select the USB mode. <ul style="list-style-type: none"> <li>• ON: The Camera can be used as a storage device.</li> <li>• OFF: Charge the Camera.</li> </ul>
Language	Press  to select the language as needed.
Unit	Press  to select the unite from <b>m</b> and <b>yd</b> .
Version	Press  to view the device information
Restore Default	Press  to restore the parameters to the defaults.
Time Set	Press  to select the time to be configured; Press  to select year, month, day, hour or minute, an then rotate  to set the value.
Time Display	Press  to display the time. <ul style="list-style-type: none"> <li>• Time: The time is displayed on the lower right corner of the screen.</li> <li>• Date&amp;Time: The date and time is displayed on the lower right corner of the screen.</li> <li>• OFF: The date and time is not displayed on the screen.</li> </ul>



## 3.4 Video and Snapshot

### 3.4.1 Recording Videos

#### 3.4.1.1 Auto Recording

When the impact sensor of the Camera detects impact, it will automatically record the video, recording the wonderful moment of hunting.



Step 1 Press and hold  to go to the standard menu.

Step 2 On the standard menu, rotate  to select  > .

Step 3 Rotate  to enable or disable **Auto REC**.

- On: The Camera will record videos when the impact sensor of the Camera detects impact.
- Off: The Camera will not record videos any time.

#### 3.4.1.2 Recording Videos

On the viewing interface, press and hold  for 3 seconds to start recording a video. The green icon  and the recording time is display.

Press and hold  again for 3 seconds to stop the recording. When the recording stops, the



recording time will display normally.

## 3.4.2 Capturing Images

On the viewing screen, press  to capture images.

The screen will display an icon when the capturing succeeds.

## 3.4.3 Exporting File

Exports the recorded and captured files.

Step 1 Connect the Camera to the computer through type-C data cable.

The driver will automatically be installed for first-time connection.



- Connect the cables before starting the Camera. Do not hot swap the type-C port of the Camera.
- Enable USB mode on the **USB Mode** configuration screen after connecting the Camera to the computer.

Step 2 On the computer desktop, double-click **My Computer**, and then open the Camera disk at a mobile storage device.

Step 3 Select the files to export and copy them to the computer.

The specific computer client is required for playing the exported files.

Step 4 Disconnect the type-C data cable with the computer.

After connecting the Camera to the computer, images can be displayed on the Camera, but the functions of recording and capturing will not be available.

## 3.5 Power Supply

You can supply power to the Camera through the rechargeable battery coming with the Camera or charging with the Type-C cable.

### 3.5.1 Installing the Battery

Step 1 Open the cover of the battery compartment.

Step 2 Put one battery into the battery compartment.



Make sure that the battery is installed with the positive electrode downward.

Step 3 Tighten the cover.

### 3.5.2 Charging

The start bar will display battery information after the Camera starts. When the battery is low, charge the Camera timely to make sure the normal function.

- During charging, keep the battery temperature 0 °C to +45 °C (+32 °F to +113 °F).

- Charge the Camera with the data cable that comes with the delivery.

Step 1 Open the sealing cover of the port when charging.

Step 2 Connect the type-C cable to the port to charge the Camera.







The charging indicator states:

- Red and green lights flashing alternately: charging error.
- Red light on: charging.
- Green light on: fully charged.
- Off: not connected to data cable to charge.

# 4 System Update

Update the Camera manually or through the app.

## 4.1 Upgrading Manually

- Step 1 Press and hold  to go to the standard menu.
- Step 2 Rotate  to select .
- Step 3 Press  to go to the **System Setting** configuration screen.
- Step 4 Rotate  to select .
- Step 5 Press  to enable USB mode.
- Step 6 Copy the upgrading file (.bin).
- Step 7 Restart the Camera.

## 4.2 Upgrading through App

When the app detects new program for upgrading, it will prompt a notification. Tap **Upgrade** to upgrade the system.

# Appendix 1 Compliance Notice

The thermal series products might be subject to export controls in various countries or regions, including without limitation, the United States, European Union, United Kingdom and/or other member countries of the Wassenaar Arrangement. Please consult your professional legal or compliance expert or local government authorities for any necessary export license requirements if you intend to transfer, export, re-export the thermal series products between different countries.