

# ***POLARIS***

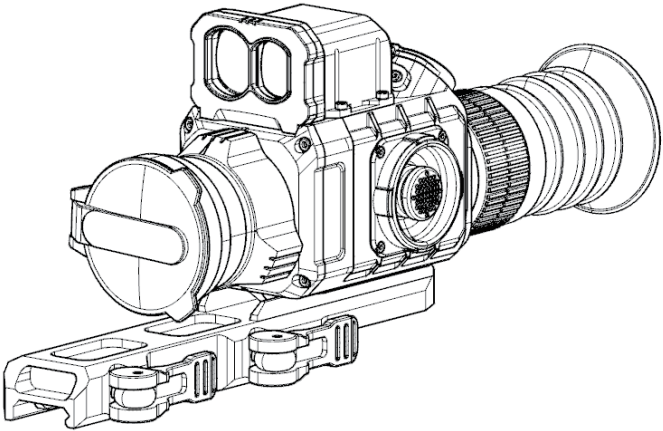

## **Attention!**

Export of **Polaris Serise** models  
May have export limitations depending on  
the laws in your region.

## Attention!



The proper usage of the device is important for safe exploitation! Therefore read carefully the present manual!



If the device was left in storage for a longer period of time, before exploitation check its functionality.



Disassembling of the device is prohibited, except in authorized repair centers.



The external optical surfaces should be clean at all times. Touching the optical surfaces with bare hands is not recommended.



Sand and sea water can damage the optical coatings!



Do not point the device directly at the sun!



Image performance is dependent on scenery and atmosphere conditions. Contrast in the same image may vary as a function of the time of day due to the effect of the sun. For example, at sunset objects will have absorbed different levels of heat resulting in greater temperature differences and better contrast.



When left in storage for a longer period of time, batteries have to be removed and stored in polyethylene bags to prevent contact with metal. (It is recommended to recharge the batteries every two to three months)



When carrying or transporting the device, put the protective lens cap!



Condensation can cause fogging of the optical surfaces! Condensation occurs when the temperature or humidity changes as follows:

- *When moving the device from cold to warm place or vice versa;*
- *In places with high humidity.*

When equalizing the temperature of the device with the environmental, the condensation disappears. Use the towel to remove moisture.



Clean the lens surfaces with the Lens Cloth or with the napkin!



**LEGAL  
NOTICE**

Before attaching to weapons, check the regional legal regulations in the area of application.

The attachment to a weapon is always the sole responsibility of the user.

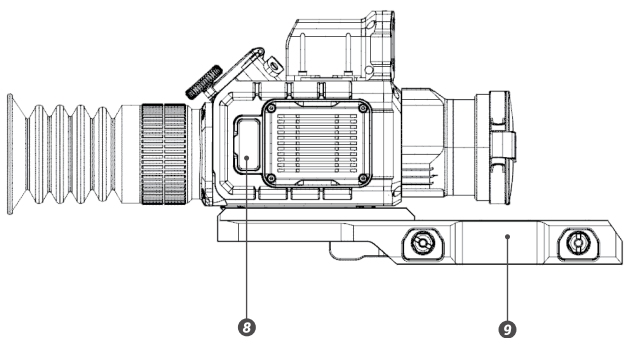
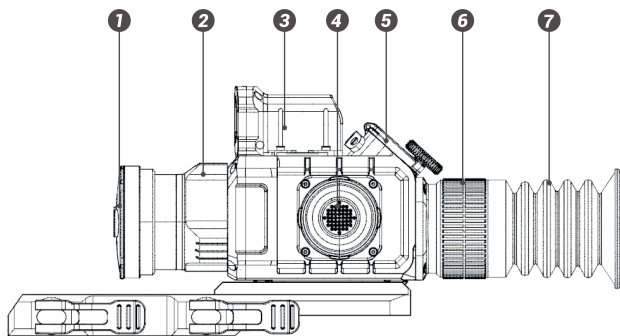



All images used in this instruction manual are for illustrative purpose only. Actual product may vary due to product enhancement.

- 1** Lens cover
- 2** Focus ring
- 3** Laser rangefinder (*RL models only*)
- 4** OneTouch Button
- 5** Battery compartment cap
- 6** Eyepiece
- 7** Eyepiece rubber
- 8** USB
- 9** Picatinny rail



### ATTENTION!

The main operations are performed through the "OneTouch Button" ( 5 position button ) .

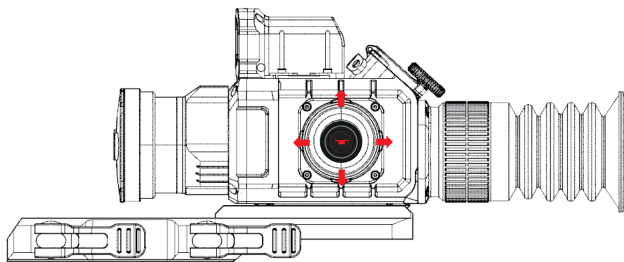

### ATTENTION!

Turn off the device after usage, otherwise you can permanently damage the batteries!

Middle



Up



Down



Left



Right



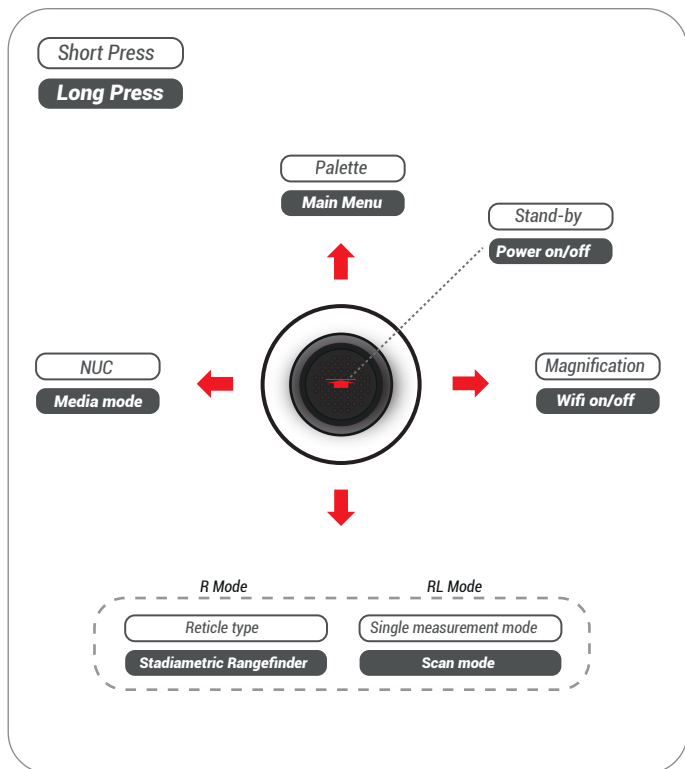

## Status Display

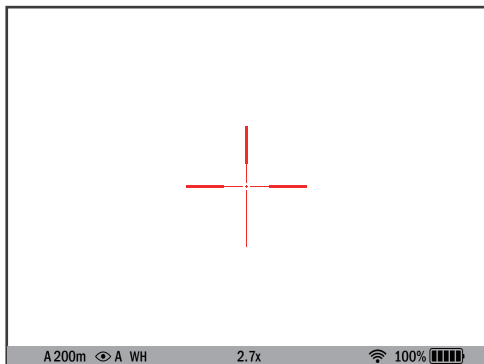

The status bar is located in the lower part of the display and shows information on the actual operating status of the sight, including:

- Zeroing profile A/B/C/D/E
- Distance display
- Display mode(A-B-C-D)
- Color palette
- Magnification
- WIFI status
- Battery capacity

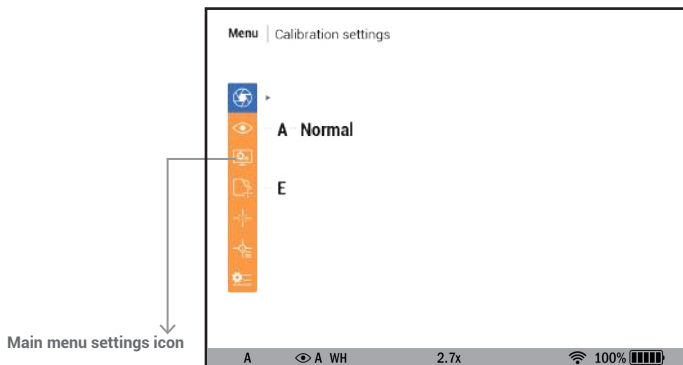



The Quick menu allows change of basic settings.

Up



### Palette

Short press **Up** Button to switch palette from C1~C6.

C1---White Hot---WH

C4---Cold Green---CG

C2---Black Hot---BH

C5---Glowbow---GB

C3---Rainbow---RB

C6---Warm White---WW

### Main Menu

Long Press **Up** Button to enter/exit Main menu.

Down



### R Mode

#### Reticle type

Short press **Down** Button to switch the Reticle type.

#### Rangefinder

Long Press **Down** Button to enter/exit Stadiametric rangefinder mode.

### RL Mode

#### Single measurement mode

Short press **Down** Button to enter Single measurement mode.

#### Scan mode

Long Press **Down** Button to enter/exit Scan mode.

Left



### NUC

Short press **Left** Button to do Non-Uniformity Calibration.

### Media mode

Long press **Left** Button to enter/exit Media mode.

Right



### Magnification/PIP

Short press **Right** Button to switch Magnification,PIP.

### WIFI

Long press **Right** Button to turn on/off Wifi.

Middle



### Stand By

Short Press **Middle** Button to make device Stand By.

Short press **Middle** button again to be back to normal display.

The device will shut down automatically after 1-hour standby.

### Power On / Off

Long Press **Middle** Button to power on /off the device.

# Stadiametric Rangefinder

Polaris R models are equipped with a stadiametric rangefinder which allows the user to estimate approximate distance to an object of known size.

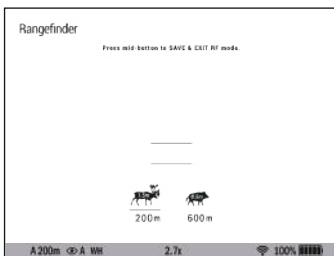
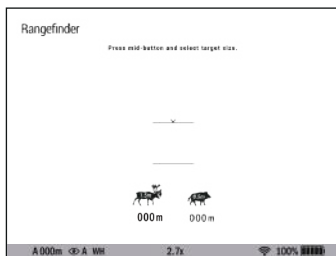

You will see on the display: measurement bars, icons of two reference objects and respective distances for the two objects.

There are two pre-set reference objects:

Wild boar-height 0.5m

Deer-height 1.5m

The lower fixed bar under the object automatically appear on display, press the **Up/Down** buttons to move the upper horizontal bar until the object fits entirely between the two lines. The distance to the object is automatically recalculated as you move the upper line. Press **Left/Right** buttons to choose reference object, press Middle button to save & exit RF mode ,range information will not disappear from display automatically.

Distance to the object displays in status bar and a " + " on reticle suggests the aiming point accordingly.

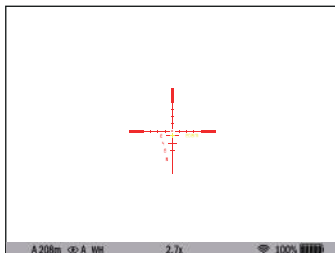

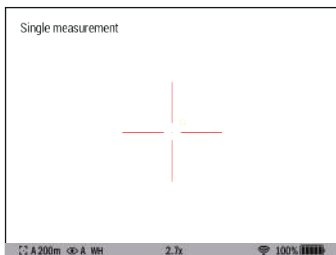

## Laser Rangefinder (RL models only)

When under real time image mode, Short press **Down** Button to enter Single measurement mode. Aim  to the target, then short press **Down** Button, the corresponding distance of target will appears on display.

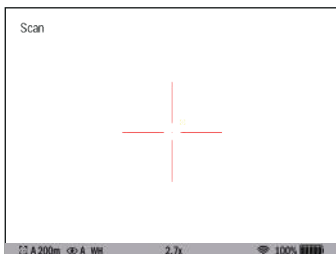

When under real time image mode, Long press **Down** Button to enter/exit scan mode. Aim  to the target, the corresponding distance of target will appear on display.



Distance to the object displays in status bar and a "  " on reticle suggests the aiming point accordingly.

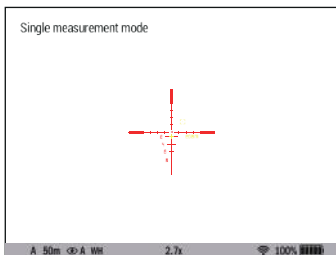

Note: When under Scan mode, "  " only can be displayed after you quit the Scan mode. And the calculation is based on the distance of your last measurement.

## WIFI

Long press **Right Button** to turn on/off Wifi.

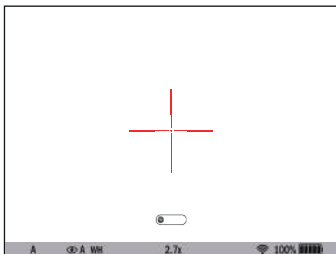
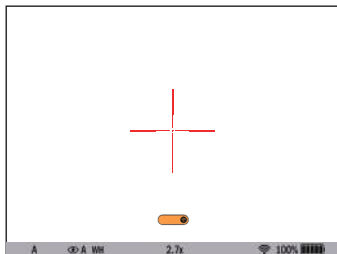

## Media mode

Long press **Left Button** to enter/exit Media mode.

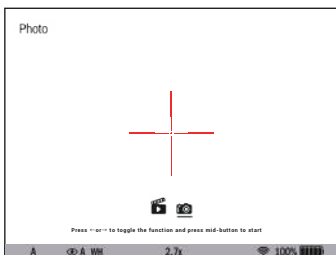
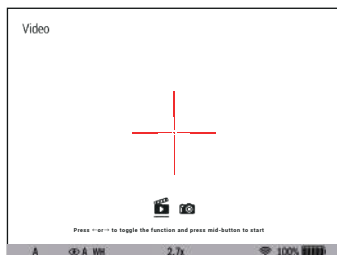

Recording icon or number of photo will be shown on the lower screen.

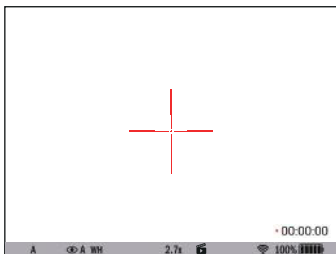
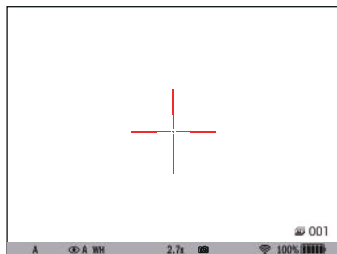

When Recording, Short press **Middle Button** to pause, short press **Middle Button** again to continue recording.  
Long press **Left Button** to exit Video and Photo function.

### Please note the following before using :

When you take photos, do not press too quickly, always wait until 001 disappears before you take 002.

You can not take photos/videos while connecting with PC. Otherwise the photos/videos are not actually saved.

## Take photo by CONOTECH

User can take photo / video on board or by CONOTECH App.  
Replay on Smart phone.

To get started, install the free CONOTECH App on your mobile device.  
You can search and download at App Store and GooglePlay.



Long press Right Button to turn on WIFI.

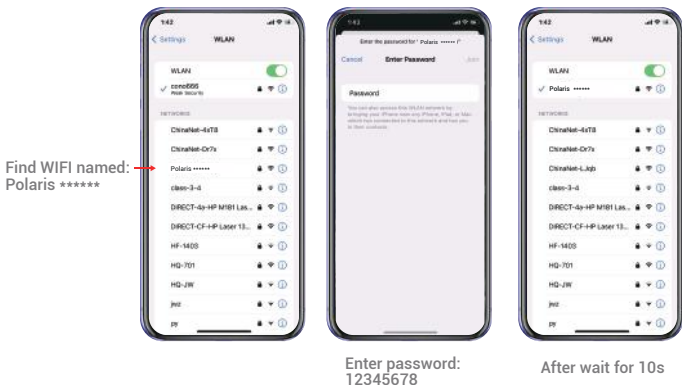



## How to replay on PC ?

- 1.Connect the Type-C usb cable to PC.
- 2.Turn on WIFI and wait 10s.

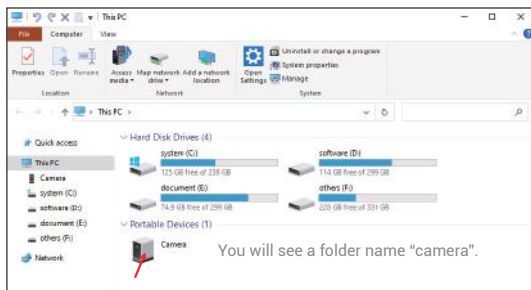

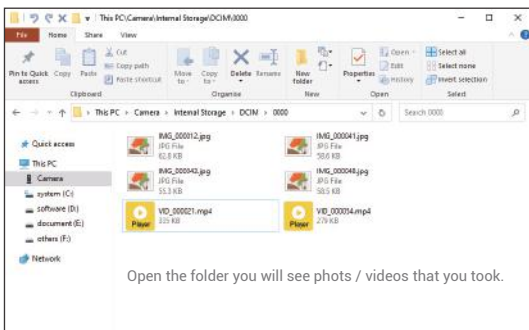
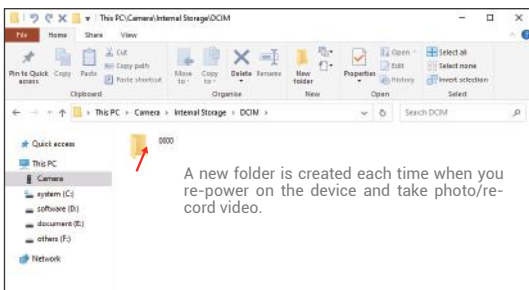
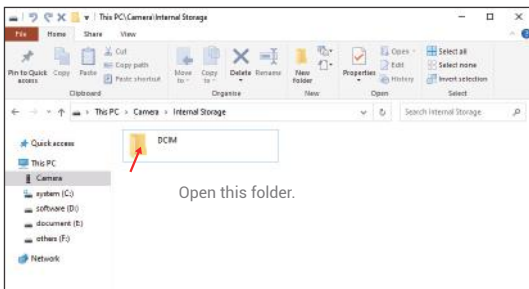



### NOTE

When under real time image, long press the Up Button to enter the main menu.  
When under main menu, long press the Up Button to return to previous menu.  
Press the Up/Down Button to select between the menu options.  
Press the Left/Right Button to change the setting.



## Calibration Setting

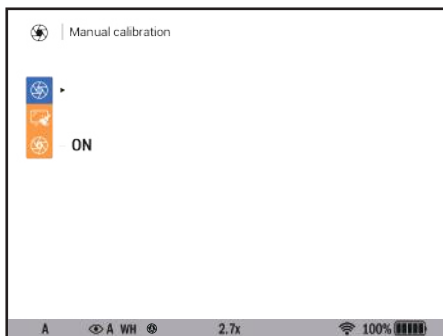

### Manual Calibration

Press **Left/Right** Button, prompt to close the lens cover, and complete after counting down 3-2-1.



### Defective Pixel Repair

Press **Left/Right** Button, prompt to close the lens cover, and complete after counting down 3-2-1.



### Auto NUC

Press **Left/Right** Button to turn Auto NUC On / Off.





## Display modes

Press Left/Right Button to switch display modes.

A ... Normal

B ... Booster

C ... Enhance

D ... User mode



## Display setting

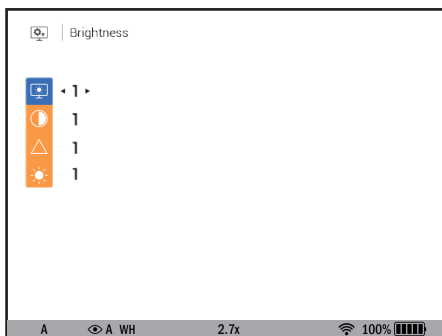

### OLED brightness

Press Left/Right Button to change OLED brightness from 1~5.



### Contrast

Press Left/Right Button to change Contrast from 1~5.



### Sharpness

Press Left/Right Button to change Sharpness from 1~5.



### Brightness

Press Left/Right Button to change image Brightness from 1~5.

**Note:** When under A/B/C display mode, you can only adjust the OLED brightness.



## Zeroing Profile

Various profiles can be used when employing the sight on different rifles and when shooting different cartridges. Select one of the zeroing profiles (shown with letters A;B;C;D;E) with short press **Left/Right** button.



## Zeroing

To zero your weapon, you need to set a zeroing distance first.

### New distance

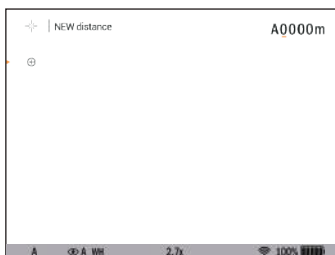

Press **Left/Right** Button and you will see **A0000m**, set the value for each digit with Press **Up/Down** Button, switch between the digits with a short press of **Left/Right** Button. Press **Middle** Button to save the new distance.

**Note:** Max number of zeroing distances is 5 for each profile.

### Distance

Press **Up/Down** Button to select the zeroing distance.



## Zeroing parameters settings

Press **Left/Right** Button to zeroing parameters settings.



## Windage /Elevation

Take a shoot, move **Up/Down/Left/Right** Button to make cross center of reticle at point of impact. X,Y will show the distance value you move.

Short press **Middle** Button to Save & Exit.

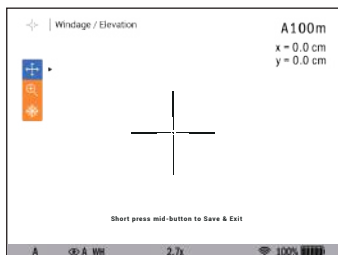

## Magnification

Magnification allows you to use a digital zoom of the riflescope when zeroing, which reduces the minute of angle click for zeroing accuracy improving. Press **Left/Right** Button to change the magnification.



## Freeze

The feature of the freeze function is that there is no need to constantly keep the riflescope at the point of aiming.

After shooting, the user needs to align the dividing center point with the center of the cross target, and then press **Left/Right** Button to freeze the infrared image of the current frame, as shown in the following figure.

Press **Left/Right** Button to unfreeze again to resume normal display of the infrared image.

When freezing the image, you can press **Up/Down** Button to adjust other options in the zero calibration.

## Change primary distance

Press **Left/Right** Button to change primary distance.



## Delete distance

Press **Left/Right** Button to delete distance.

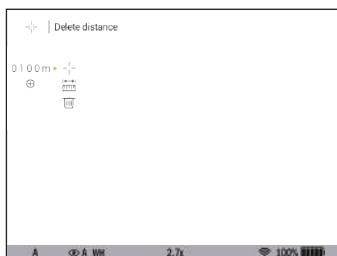

When zeroing is finished, the hundred digits of the distance you set will be displayed on the reticle.

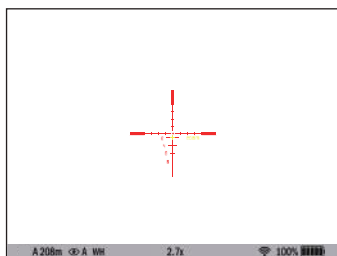



## Reticle settings

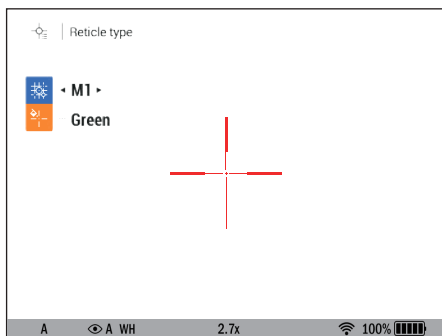

### Reticle type

Press Left/Right Button to select the reticle type.

#### M1

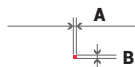
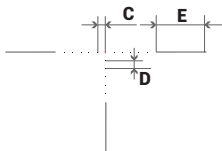

Reticle	MOA/cm@100m			
	384(35mm)	384(35mm)	640(35mm)	640(50mm)
Section A	1.2/4.8	1.2/3.4	1.6/4.6	1.1/3.2
Section B	1.2/4.8	1.2/3.4	1.6/4.6	1.1/3.2
Section C	5.8/24	5.8/17	8/23	5.5/16
Section D	5.8/24	5.8/17	8/23	5.5/16
Section E	37.3/156	37.7/110.5	52/119.6	35.75/104

#### M2

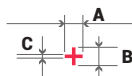
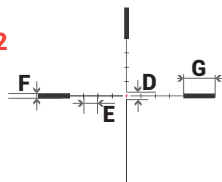

Reticle	MOA/cm@100m			
	384(35mm)	384(35mm)	640(35mm)	640(50mm)
Section A	2.9/7.2	2.9/5.5	4.8/13.8	3.3/9.6
Section B	2.9/7.2	2.9/5.5	4.8/13.8	3.3/9.6
Section C	1.2/4.8	1.2/3.4	1.6/4.6	1.1/3.2
Section D	6.38/26.4	6.38/18.7	6.4/18.4	4.4/12.8
Section E	11.6/48	11.6/48	16/46	11/32
Section F	4.06/16.8	4.06/11.9	6.4/18.4	4.4/12.8
Section G	26.68/110.4	26.68/78.2	36.8/105.8	25.3/73.6

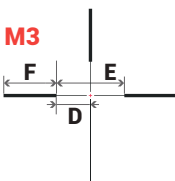

Reticle	MOA/cm@100m			
parameters	384(35mm)	384(50mm)	640(35mm)	640(50mm)
Section A	2.9/12	2.9/8.5	4.8/13.8	3.3/9.6
Section B	2.9/12	2.9/8.5	4.8/13.8	3.3/9.6
Section C	1.2/4.8	1.2/3.4	1.6/4.6	1.1/3.2
Section D	29/120	29/85	40/115	27.5/180
Section E	58/240	58/170	80/230	55/160
Section F	46.11/19.08	46.11/135.15	64/184	44/128

**M4**

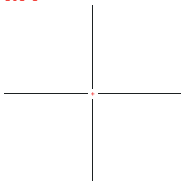

Reticle	MOA/cm@100m			
parameters	384(35mm)	384(50mm)	640(35mm)	640(50mm)
Section A	2.9/12	2.9/8.5	4.8/13.8	3.3/9.6
Section B	2.9/12	2.9/8.5	4.8/13.8	3.3/9.6
Section C	1.2/4.8	1.2/3.4	1.6/4.6	1.1/3.2

**M5**



Reticle	MOA/cm@100m			
parameters	384(35mm)	384(50mm)	640(35mm)	640(50mm)
Section A	1.2/4.8	1.2/3.4	1.6/4.6	1.1/3.2
Section B	1.2/4.8	1.2/3.4	1.6/4.6	1.1/3.2



## Reticle Colour

Press **Left/Right** Button to select the desired reticle colour: black, white, red and green.



## System settings

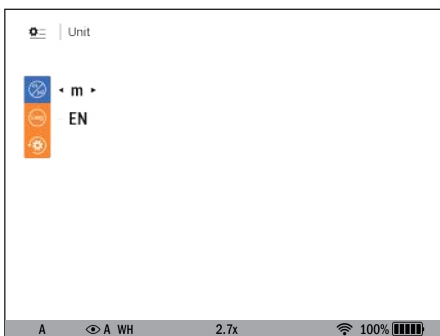

### Unit

Press **Left/Right** Button to select units of measurement from Yards and Meters.



### Language

Press **Left/Right** Button to select language and press **Middle** Button to save.



### Restore Default Setting

Press **Left/Right** Button to Restore Default Setting.  
(All parameter settings are restored to default values)

## Battery Installation

Turn the battery compartment knob counterclockwise until stop.

Please install the battery according to the positive and negative signs. Otherwise, the Polaris will not start.

Replace the battery and close the compartment knob.

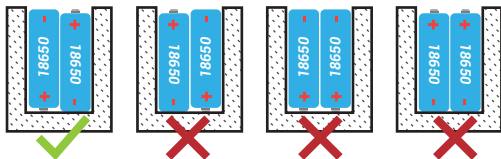
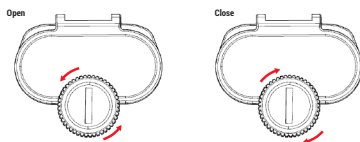

Battery charge level is displayed on the status bar.



### NOTE:

Zeroing information will be saved when unit shut down due to empty battery.

If unit is shut down by opening battery cover without proper power off, Zeroing information will not be saved.



1. Power supply / Firmware update



Serves for external power supply and firmware update

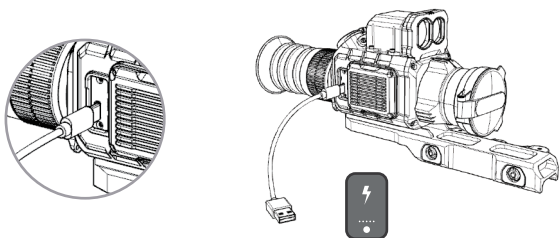

## Picatinny Rail Installation

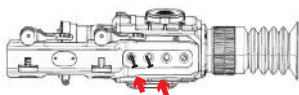
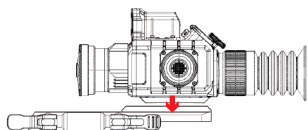

Step 1 Step 2

Step 3 Step 4

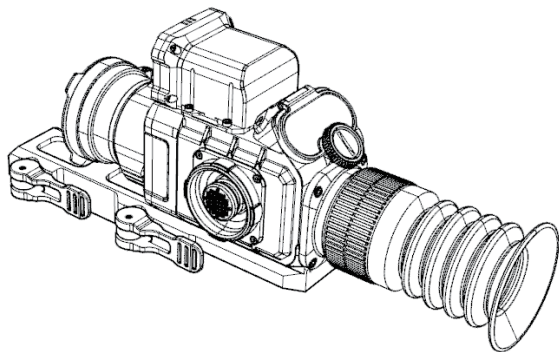
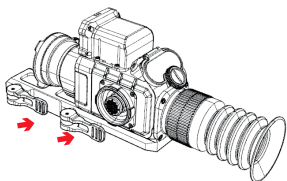
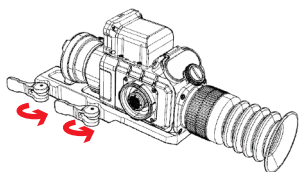

- Before storing it, clean obligatory the device (if on its surface there are moisture, dust or traces of dirt)!
- Make sure that there are no traces of moisture, and the battery compartment is empty!
- It is also possible for a short periods of time device to be stored in a suitable soft pack, bag or cartridge box.
- The premises in which the device is kept for long term have to be dry, enclosed, unheated and ventilated.
- During the storage should not be allowed exposure to aggressive environments, temperatures below  $-50^{\circ}\text{C}$  and above  $+60^{\circ}\text{C}$ , relative humidity greater than 80%, and prolonged periods of direct sunlight.
- Before each transportation, the product should be neatly packed in its original packaging (transport bag) and all other items and accessories should be carefully and steadily placed in the bag. After that the bag should be steadily placed in the transport suitcase.
- You can ship the product with all types of transport at different distances and at altitude up to 12000 m.

## Polaris Technical Data Sheet

Polaris Technical Data Sheet								
	335R	335RL	350R	350RL	635R	635RL	650R	650RL
<b>Detector</b>								
Type	Uncooled Vox				Uncooled Vox			
Resolution	384x288				640X512			
Frame rate	50Hz				50Hz			
Pitch	12µm				12µm			
Spectral range	8-14µm				8-14µm			
NETD	<25mk				<25mk			
<b>Optical Characteristics</b>								
Objective lens	35mm/F1.1		50mm/F1.1		35mm/F1.0		50mm/1.0	
Magnification	2.7x		3.8x		1.5X		2.2X	
FOV	7.5°x5.6°		5.3° x 4°		12.6°X10°		8.8°X7°	
Close-up range	5m				5m			
Dioptr adjustment	-5D-4D				-5D-4D			
<b>Functions</b>								
Zoom	2x/4x/PIP				2x/4x/8x/PIP			
Palette	6 optional				6 optional			
Start up time	Less than 5 seconds				Less than 5 seconds			
Image enhancement	DDE				DDE			
Contrast and brightness	AGC				AGC			
Online update	Both code and GUI resources				Both code and GUI resources			
<b>Display</b>								
Type	OLED				OLED			
Resolution	1024x768				1024x768			
External video	WiFi				WiFi			
Storage	32G				32G			
<b>Power Supply</b>								
Battery	2x18650				2x18650			
External power supply	5V Type-C				5V Type-C			
Working time with battery	8h				6.5h			
<b>Physical Characteristics</b>								
Weight without battery	618g	688g	650g	720g	623g	693g	665g	720g
Size(mm)	180*76*83	180*76*100	196*76*83	196*76*100	178*76*83	178*76*100	188*76*83	188*76*100
<b>Environmental Compatibility</b>								
Water proof	IP67				IP67			
Operating temperature	-20°C-50°C				-20°C-50°C			
Storage temperature	-40°C-60°C				-40°C-60°C			
<b>Laser Rangefinder(Optional)</b>								
Safety class for laser equipment according to IEC 60825-1:2014	/	1	/	1	/	1	/	1
Measuring range	/	5-1000m	/	5-1000m	/	5-1000m	/	5-1000m
Measurement accuracy	/	±1m	/	±1m	/	±1m	/	±1m



Wuhan CONO Technology Co., Ltd  
Tel/ Fax:0086-27-86635300  
Email: [Support@cono-tech.com](mailto:Support@cono-tech.com)  
[www.cono-tech.com](http://www.cono-tech.com)