



## Basic

# SQ10 Series Network Square Speaker

ZYCOO Network Square Speaker SQ10 Basic is a comprehensive, high-performance SIP-enabled speaker. With the built-in microphone, the operators can delivery two-way communication at any time, anywhere. It is perfect to use in scenarios like classrooms, libraries, offices. Plus, it provides both surface-mounted and flush-mounted enclosures to choose from regarding different application scenarios.

## Applicable Scenarios



Schools



Health Care



Office Buildings



Hotel Lobbies



Airports



Pharmacies



Banks



Residential Buildings



Restaurants



Hospitals

## Features



### Audio

320Kbps superior quality MP3 music files and streamed media music supported. Click to play music, immediate announcement, intercom, schedule music and paging are all supported.



### Microphone

Integrated microphone allows for half-duplex or full-duplex paging based on software platform used. When used with the push button, calls to a predetermined extension or trigger a task can be initiated from the room with the speaker.



### PoE+

SQ10 is PoE supported, making it easy to connect into local area networks from your PoE switch with a CAT 5/6 cable. No extra power cables are needed.



### SIP Integration

Standard SIP protocol implemented, you can register the SQ10 into any third-party SIP server such as IPPBX system or PA system.



### Peripheral Integration

With the support of peripheral integration, the SQ10 can connect with strobes, call buttons, volume controllers, external LED/LCD monitors, door magnetism, etc.



### Diverse Installation

Four additional knockout holes are implemented along each side of the enclosure, allow cables to plug into the speaker in any direction.

## Specifications

<b>Speaker</b>	
Speaker Size	4.5 inch
Average Sensitivity	91dB/1m/1W
Frequency Response	70Hz~20KHz
THD	<0.1%
Max SPL at 1m (Passive)	101dB
Amplifier	Single-Chanel Class D Topology
Rated Power	8Ω 10W
Coverage Pattern	90°H 50°V 30m <sup>2</sup>
<b>Audio</b>	
Network Audio Types	G.722, G.711 A-law, G.711 U-law, Opus
<b>Network</b>	
Ethernet	IEEE 802.3 10/100Base-T
PoE	IEEE 802.3 AT Compliant
Supported Protocols	SIP(RFC3261), HTTP, TCP/IP, SSL, DNS, SNTP, NTP, RTSP, RTP, RTCP, TCP, UDP, MQTT, ICMP, DHCP,
IP Addressing	DHCP / Static
<b>Mechanical Properties</b>	
Memory	128MB RAM, 256MB Flash
AC Power Input	PoE+ and External 24VDC
Casing Material	Cold rolled steel finished in textured white epoxy
Mounting Method	Wall mounted
Color	White
Weight	3.15kg(6.95lb)
Dimensions – Surface-mounted	280*280*65mm
Dimensions – Flush-mounted	300*300*65mm
SYS Light Status	On/Off/Flash
PWR Light Status	On/Off/Flash
RST Key	Press and hold for 3 seconds to announce IP address; Press and hold for 10 seconds to reset device to factory defaults.
<b>Environmental</b>	
Installation Environment	Indoor
Operating Temperature	-20°C - 50°C (-4°F - 122°F)
Storage Temperature	-40°C - 70°C (-40°F - 158°F)
Humidity	10% - 95% RH Non-condensing
<b>Approvals</b>	
Approvals	EN 55032:2015, EN 55035:2017, EN 61000-3-2:2014, EN 61000-3-3:2013, EN 62368-1:2014+A11:2017, FCC Part 15B Class A
<b>Warranty Coverage</b>	
Warranty Period	2 Year Limited

# Dimensioning

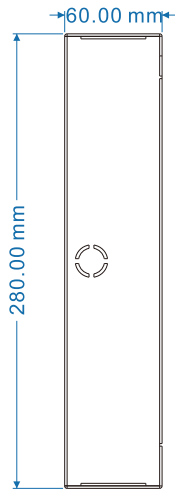

Side

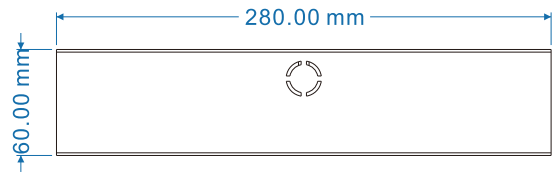

Top

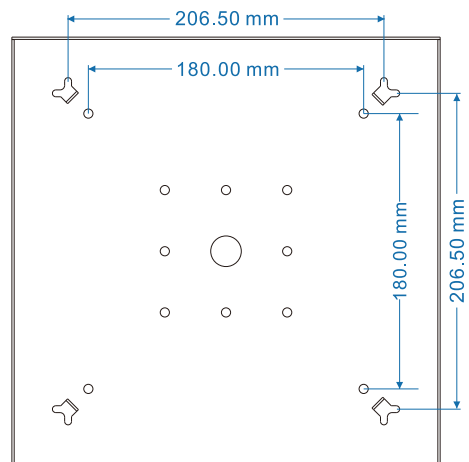

Rear-back

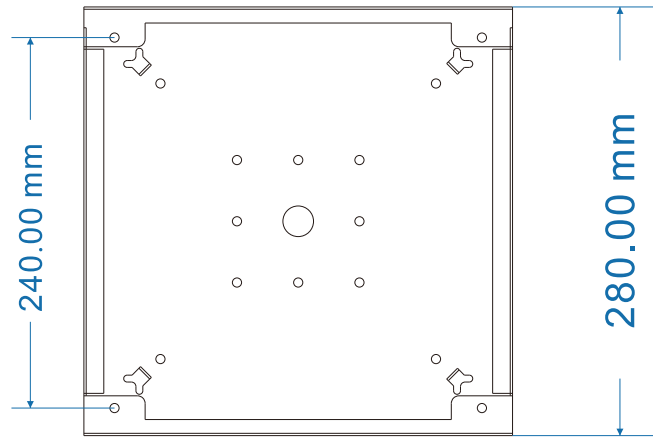

Rear-front

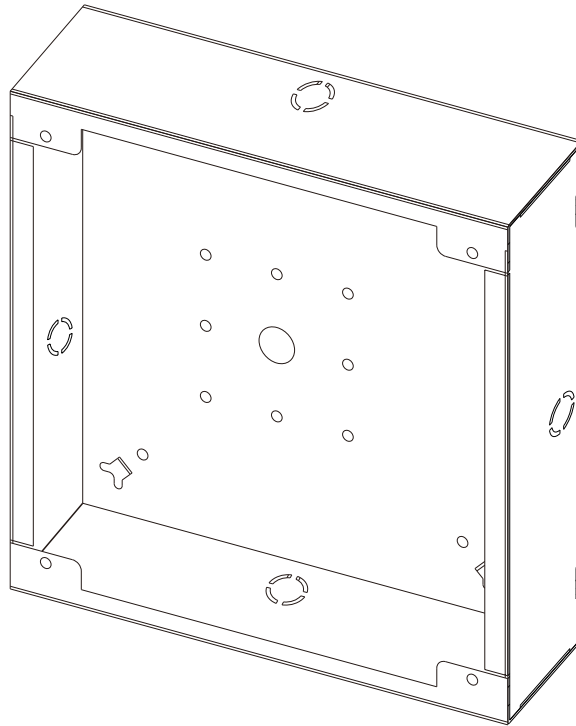

(Perspective)

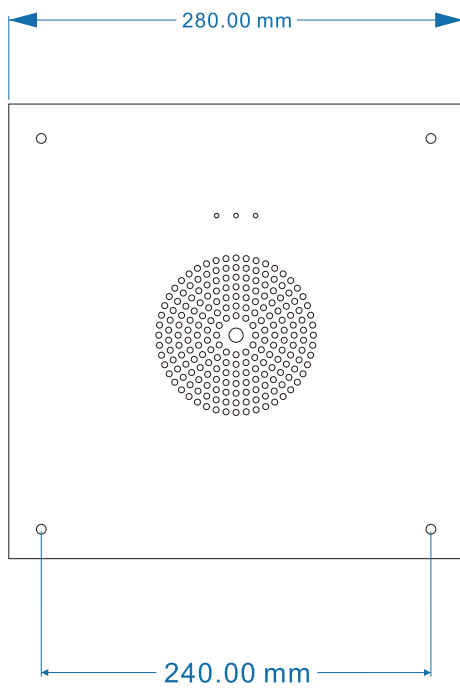

(SQ10-B)

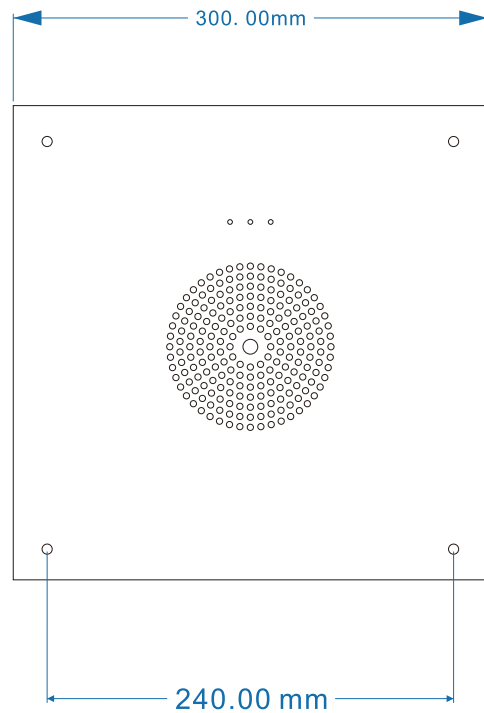

(SQ10-BF)



We Focus · We Deliver

---

16F, D5, Tianfu Software Park, Chengdu, China

+86 28 85337096

[zycoo@zycoo.com](mailto:zycoo@zycoo.com)