

TRACER⁶

THERMAL IMAGING MONOCULAR

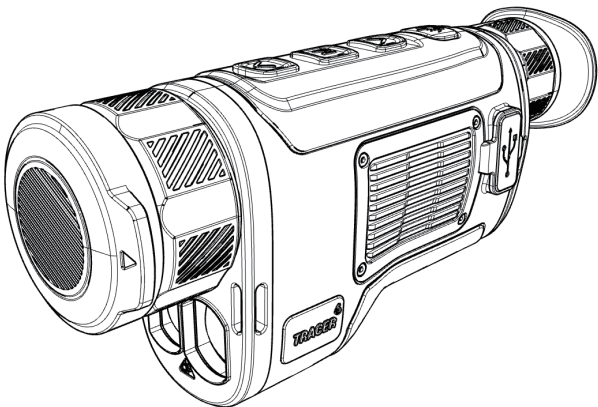
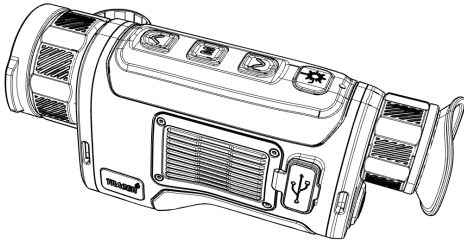

Attention!

Export of *Tracer⁶ 35/50LRF* models.
May have export limitations depending on
the laws in your region.

RoHS  

ATTENTION!



The proper usage of the device is important for safe exploitation!
Therefore read carefully the present manual!



If the device was left in storage for a longer period of time, before exploitation check its functionality.



Disassembling of the device is prohibited, except in authorized repair centers.



The external optical surfaces should be clean at all times. Touching the optical surfaces with bare hands is not recommended.



Sand and sea water can damage the optical coatings!



Do not point the device directly at the sun!



Image performance is dependent on scenery and atmosphere conditions. Contrast in the same image may vary as a function of the time of day due to the effect of the sun. For example, at sunset objects will have absorbed different levels of heat resulting in greater temperature differences and better contrast.



When left in storage for a longer period of time, batteries have to be removed and stored in polyethylene bags to prevent contact with metal. (It is recommended to recharge the batteries every two to three months)



When carrying or transporting the device, put the protective lens cap!



Condensation can cause fogging of the optical surfaces! Condensation occurs when the temperature or humidity changes as follows:

- *When moving the device from cold to warm place or vice versa;*
- *In places with high humidity.*

When equalizing the temperature of the device with the environmental, the condensation disappears. Use the towel to remove moisture.



Clean the lens surfaces with the Lens Cloth or with the napkin!

LEGAL NOTICE

Before attaching to weapons, check the regional legal regulations in the area of application. The attachment to a weapon is always the sole responsibility of the user.



All images used in this instruction manual are for illustrative purpose only. Actual product may vary due to product enhancement.

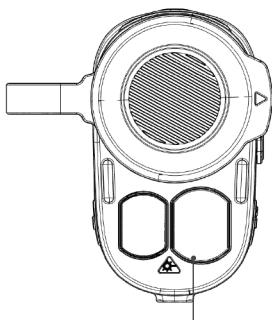
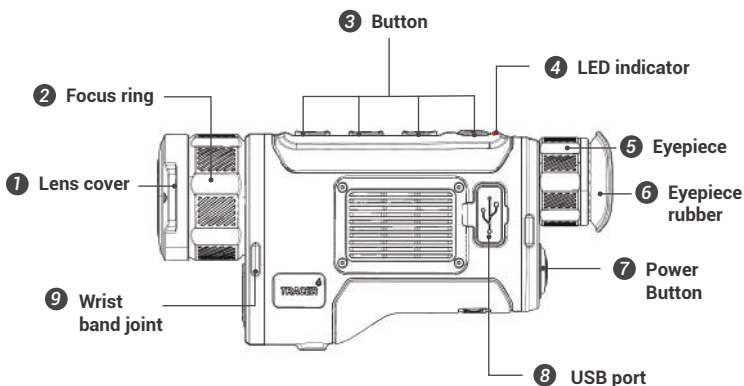

CLASS 1
LASER PRODUCT
BS/EN 60825-1:2014

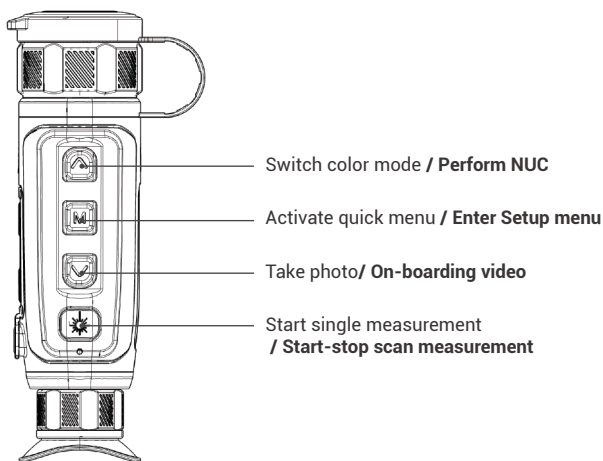

Palette

Short press  button to switch the color modes activated in the setup menu.

NUC

Long press  button to perform non-uniforming calibration.

Take photo / video recording

Short press  button to take photo, number of photo will be shown in the top left of screen.

long press  button to start/stop video recording, recording icon will be shown in the top left of screen.

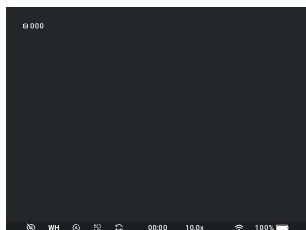
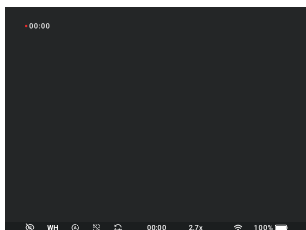

Take photo by CONOTECH

User can take photo / video by CONOTECH App.
Replay on Smart phone.

To get started, install the free CONOTECH App on your mobile device.
You can search and download at App Store and GooglePlay.



CONOTECH

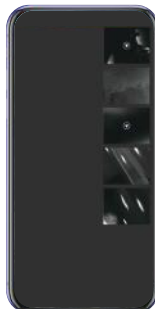

How to replay on PC ?

- 1.Connect the Type-C usb cable to PC.
- 2.Turn on WIFI and wait 10s.

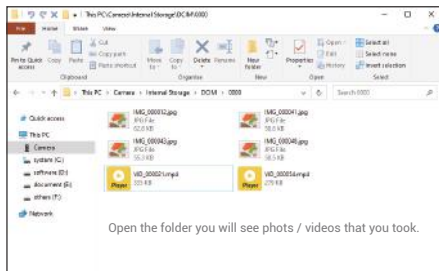
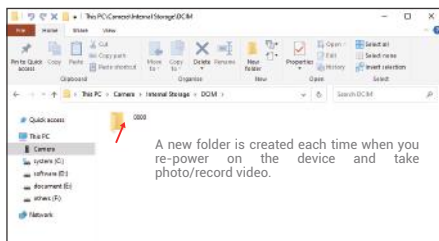
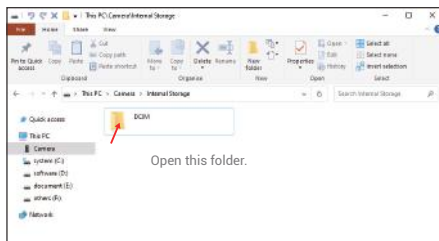
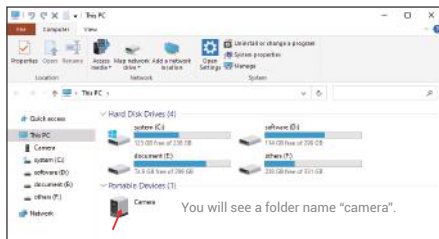

Laser rangefinder

Short press the  button, the ranging box and distance appear.

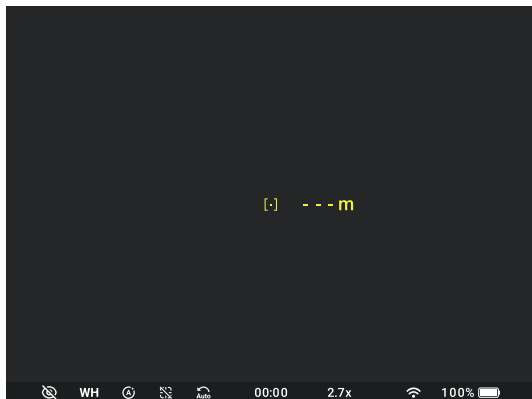

Short press the  button to have range measured once and displayed.

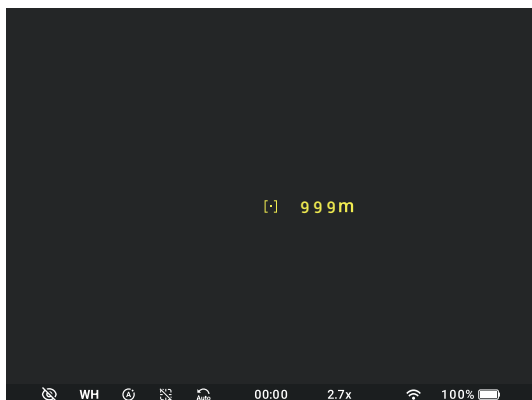

The distance is displayed for 5 seconds then disappear.

Long press  button to start the scan mode, and the scan mode ranging box and distance appear in the real-time image.

Long press  button again to turn off the scan mode. The ranging box and figures will disappear together.

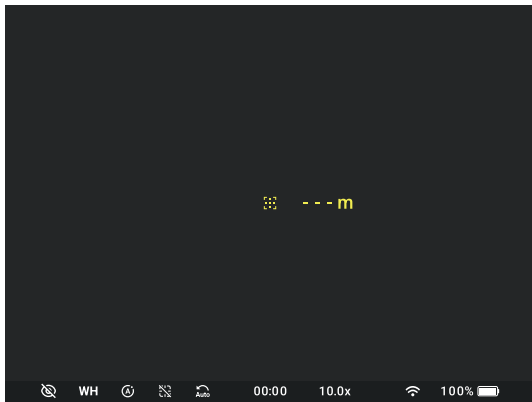

OPERATING FEATURES:

- 1.The accuracy and distance of the measurement depends on the reflection coefficient of the object surface and weather conditions. The reflection coefficient depends on the texture, color, size and shape of the object. Generally, lighter colored objects and those with a shiny surface will have a higher reflection coefficient.
- 2.Measurement accuracy can be influenced by the light conditions, fog, haze, rain, snow, etc. The results may be less accurate when operating in sunny weather or if the rangefinder is directed towards the sun.
- 3.It is easier and more reliable to measure the distance to large objects than to small ones.
- 4.The distance of measurement is able to display on your mobile device by CONOTECH App.

Start up image

Long press of  button for 3 second to power on device.

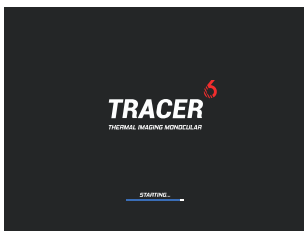
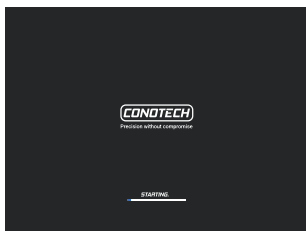

Power off image

Long press of  button for 3 seconds to power off device.

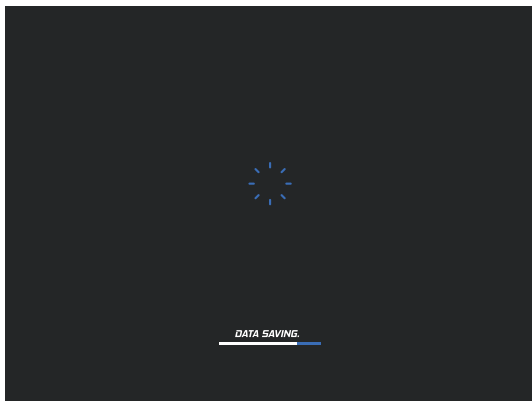

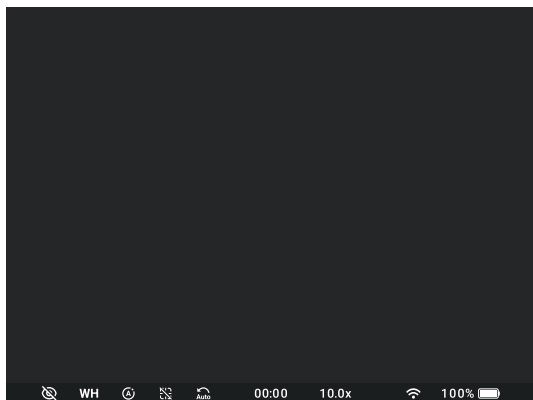

The status display shows information on the actual operating status of the device including:

- **Extreme mode**
- **Color mode** (WH, BH, RH SE, RM, UM, RB, VL)
- **Calibration mode** (Automatic, Manual, Silent)
- **Standby** (Auto, 2min, 5min)
- **Time**
- **Zoom** (35---7.6X, 50---10.8X)
- **WiFi**
- **Battery capacity**

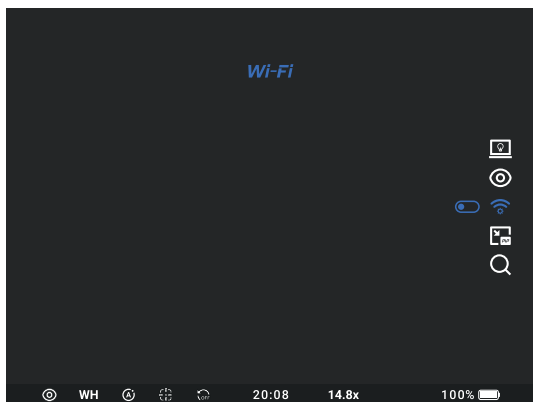

Short press **[M]** button under real time image to activate quick menu.

Quick menu icons show on the right side of screen.

Press **[M]** button shortly to switch from quick menu setting, short press **[^]** and **[v]** button to select and confirm setting.

Long press **[M]** button to exit quick menu.



NOTE

- 1.If there is no operation within 5 seconds, it will exit quick menu automatically.
- 2.The cursor will stay at last icon if re-activating the quick menu within 1 second; the cursor will stay at default function (Zoom), If re-activating the quick menu after 3 seconds.



Zoom

Short press **[^]** or **[v]** button to have smooth zoom in and out.

Tracer 635LRF has magnification from 1.9~7.6X.

Tracer 650LRF has magnification from 2.7~10.8X.

PIP

Short press  or  button to turn PIP mode On/Off.

 means the PIP mode is on,  means the PIP mode is off.

Wi-Fi

Short press  or  button to turn Wi-Fi On/Off.

 means the Wi-Fi is on,  means the Wi-Fi is off.

Wi-Fi status is shown in the display,  means Wi-Fi is on.

Find WiFi named:
Tracer LRF *****

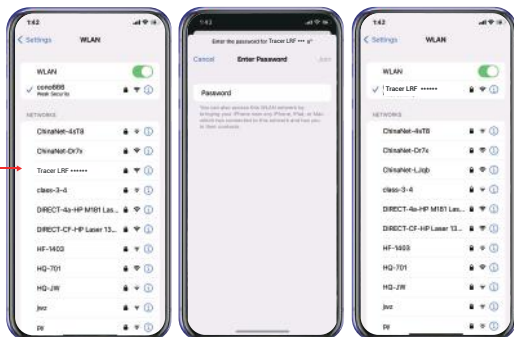

Enter password:
12345678

After wait for 10s

Extreme Mode

Short press  or  button to turn Extreme Mode On/off.

 means the Extreme mode is on,  means the Extreme mode is off.

Screen Brightness

Short press  or  button to adjust the screen brightness from 1 to 10.

The default brightness is 5.



NOTE

When under real time image, long press **M** button to Enter/Exit Setup menu.
 Short press **M** button to enter sub-menu.
 Short press **Up/Down** button to select between the menu options.
 Long press **M** button to exit sub-menu.

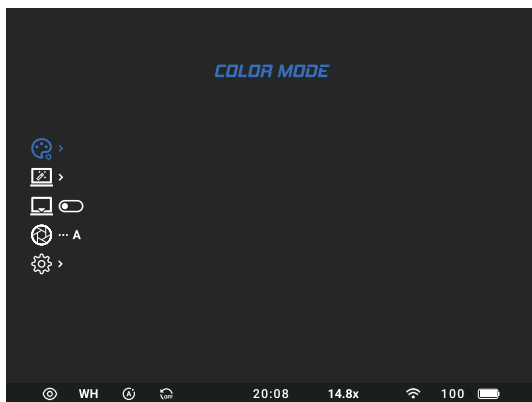

Color Mode

Short press and button to select different color modes.

Short press button to activate/deactivate the selected color mode.

means the color mode is on, means the color mode is off.

The activated color models will appear in the quick menu for switching.



WH-WHITE HOT

BH-BLACK HOT

RH-RED HOT

SE-SEPIA



RM-RED MONOCROME

UM-ULTRAMARINE

RB-RAINBOW

VL-VIOLET



Defective Repair

Cover lens cover, shot press  button perform defective pixel repair.



Pure Mode

Short press  button to turn on/off pure mode.



Calibration Mode

Short press  button to select Automatic Calibration Mode, Manual Calibration Mode or Silent Calibration Mode.



Advanced Setting

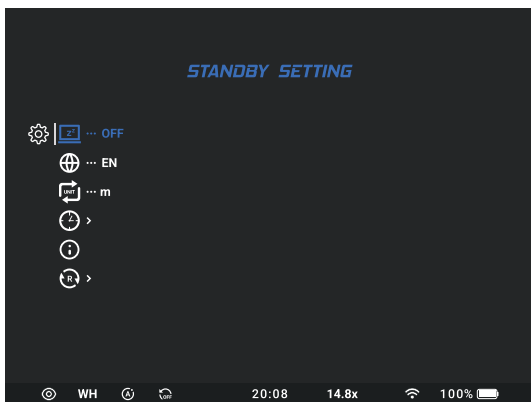



Standby setting

Short press or button to select Standby setting from Reset and Language.

Short press button to enter Standby setting, short press or button to switch from Auto, 2min, 5min or Off. Then short press button to save setting.

Auto is set to automatically activate Standby mode if no operation within 1min.
2min is set to automatically activate Standby mode if no operation within 2mins.
5min is set to automatically activate Standby mode if no operation within 5mins.
Off is set to turn off Standby mode.



Language

Short press or button to select Language from Standby setting and Unit.

Short press button to enter Language, short press or button to switch from EN, KR, ES, CZ, RU, DE. Then short press button to save setting.



Unit

Short press or button to select Unit from Language and Date/Time.

Short press button to enter Unit, short press or button to switch between m and yard. Then short press button to save setting.



Date/Time



Short press or button to select Unit from Device Info and Unit.

Short press button to enter Date/Time, short press or button to change and save the selected the number, then short press the button to switch to next number, long press M button to exit Date/Time setting.



> 2022/08/30 20:22

Device Info

Short press  or  button to select from Date/Time and Reset.

Reset

Short press  or  button to select from Device info and Standby setting.

Short press  button to enter Reset, short press  or  to switch between Yes and No. Then short press  button to perform Reset.

The Tracer LRF series comes with built-in rechargeable Lithium-ion battery. Before first use, make sure the battery is fully charged.

Power supply / Firmware update

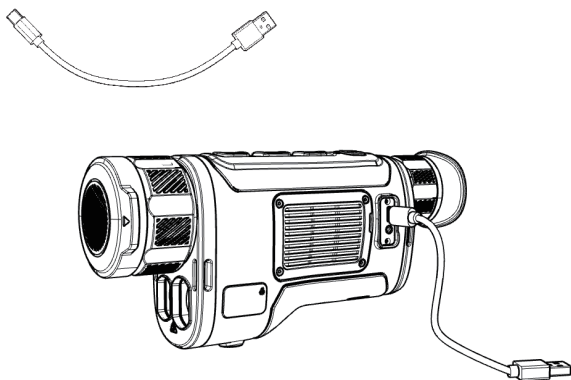

When charging the LED light will be in red color.

When battery is fully charged LED light will be in green color.



Attention

It is not recommended to use when charging, which will shorten the battery life.

Charging batteries from an external source at temperatures below 0°C can reduce battery life.

When using external power, connect the Power Bank to the device only after it has been turned on and working for at least several minutes.

- Before storing it, clean obligatory the device (if on its surface there are moisture, dust or traces of dirt)!
- Make sure that there are no traces of moisture, and the battery compartment is empty!
- It is also possible for a short periods of time device to be stored in a suitable soft pack, bag or cartridge box.
- The premises in which the device is kept for long term have to be dry, enclosed, unheated and ventilated.
- During the storage should not be allowed exposure to aggressive environments, temperatures below -50°C and above $+60^{\circ}\text{C}$, relative humidity greater than 80%, and prolonged periods of direct sunlight.
- Before each transportation, the product should be neatly packed in its original packaging (transport bag) and all other items and accessories should be carefully and steadily placed in the bag. After that the bag should be steadily placed in the transport suitcase.
- You can ship the product with all types of transport at different distances and at altitude up to 12 000 m.

Technical Data Sheet		
	Tracer [®] 35LRF	Tracer [®] 50LRF
Detector		
Type		
Resolution	640x512	
Frame rate	50Hz	
Pixel	12μm	
Spectral range	8-14μm	
NETD	<25mk	
Optical Characteristics		
Objective lens	35mm	50mm
Magnification	1.9x	2.7x
FOV	12.57°x10°	8.8°x7°
Close-up range	5m	
Dioptr adjustment	-5D-4D	
Functions		
Zoom	1X/2X/4X	
Palette	6 optional(can be customized)	
Start up time	Less than 5 seconds	
Image enhancement	DDE	
Contrast and brightness	AGC	
Online update	Both code and GUI resources	
Display		
Type	OLED	
Resolution	1024×768	
Power Supply		
Battery	Built-in lithium battery	
External power supply	5V Type-C	
Battery life	8h+	
Physical Characteristics		
Weight without battery	550g	600g
Size (mm)	180x56x95.5	183x60x92
Physical Characteristics		
Water proof	IP67	
Operating temperature	-20℃-50℃	
Storage temperature	-40℃-60℃	
Physical Characteristics		
Safety class for laser equipment according to IEC 60825-1:2014	1	
Measuring range	5-1000m	
Measurement accuracy	±1m	

CONOTECH

Wuhan CONO Technology Co., Ltd
Tel/ Fax:0086-27-86635300
Email: Support@cono-tech.com

www.cono-tech.com