



User Manual

EV AC Charger

SUN-EVSE11K01-EU-AC

SUN-EVSE22K01-EU-AC



Contents

All Rights Reserved	01
About This Manual	01-02
1 Safe Introductions.....	03
2 Introduction.....	04-06
2.1 Introduction of installation methods	
2.2 Model	
2.3 Appearance and Dimensions	
2.4 System Topology	
3 Installation	07-10
3.1 Installation	
3.2 Unpacking and Inspection	
3.3 Installation Tools	
3.4 Electrical Connection	
3.4.1 Circuit Diagram	
3.4.2 Recommended specification of AC cable and PE	
3.4.3 Single phase connection	
3.4.4 Three phase connection	
4 Inspection before Commissioning	11-12
5 WiFi and Lora configuration	13-24
5.1 WiFi configuration	
5.1.1 WIFI configuration via APP	
5.1.2 WIFI configuration via localhost	
5.2.Lora configuration	
5.2.1 Steps to establish Lora communication	
5.2.2 Adjustment of Lora communication channel	
6 Setting of communication mode	25
7 Local control mode	26-27
7.1 Explanation of parameters	
7.2 View operating status via LCD	
8 Remote control via APP	28-35
9 Troubleshooting.....	36-37
10 Technical Data.....	38-39
11 EU Declaration of Conformity.....	39

All Rights Reserved

All Rights Reserved

No part of this document can be reproduced in any form or by any means without the prior written permission of Ningbo Deye Inverter Technology Co., Ltd. (hereinafter "DEYE").

Trademarks

DEYE and other DEYE trademarks used in this manual are owned by DEYE.

All other trademarks or registered trademarks mentioned in this manual are owned by their respective owners.

Software Licenses

- It is prohibited to use data contained in firmware or software developed by DEYE, in part or in full, for commercial purposes by any means.
- It is prohibited to perform reverse engineering, cracking, or any other operations that compromise the original program design of the software developed by DEYE.

Privacy Protection

- Information contained in this manual is the private property of Ningbo Deye Inverter Technology Co., Ltd. No part of this manual may be transmitted in any form without the prior written permission of Ningbo Deye Inverter Technology Co., Ltd. Internal reproduction is allowed only for product evaluation or other appropriate purposes.
- We declare that the network account and password data stored in the device system shall be used solely for the remote control and monitoring of the device, and shall not be transmitted to any third-party data platform without the user's permission.
- At our EV charger, we take the privacy of our customers seriously. We only collect charging information in accordance with applicable privacy laws and regulations.

Disposal

After the service life of the charger ends, please dispose of it in accordance with the applicable electrical waste disposal act at the installation location. It can also be returned to Ningbo Deye Inverter Technology Co., Ltd., but the relevant expenses shall be borne by your party.

About This Manual

The manual mainly contains product information, as well as guidelines for installation, operation, and maintenance.

Target Group

This manual is intended for qualified technicians who are responsible for the installation, operation, and maintenance of the charger, and end users who need to check charger parameters.

A qualified technician is required to meet the following requirements:

- Knowledge of electronics, electricity, and machinery, and be familiar with electrical and mechanical schematic diagrams.
- Training in the installation and commissioning of electrical equipment.
- Be able to quickly respond to hazards or emergencies that occur during installation and commissioning.
- Be familiar with local standards and relevant safety regulations of electrical systems.
- Read this manual thoroughly and understand the safety instructions related to operations.

EMC

In some cases, even if the equipment is in accordance with the standard emission limits, it can have an impact in certain application areas (some sensitive equipment is placed in the same location; the equipment is installed close to a radio or TV receiver), and the operator is obliged to take appropriate action to correct this situation.

How to Use This Manual

Please read this manual carefully before using the product and keep it properly in a place for easy access.

All contents, pictures, marks, and symbols in this manual are owned by DEYE. No part of this document may be reprinted by the non-internal staff of DEYE without written authorization.

Contents of this manual may be periodically updated or revised, and the actual product purchased shall prevail. Users can obtain the latest manual from service@deye.com.cn.

Symbols

This manual contains important safety instructions, which are highlighted with the following symbols, to ensure personal and property safety during usage, or to help optimize the product performance efficiently.



DANGER

Indicates high-risk potential hazards that, if not avoided, may lead to death or serious injury.



WARNING

Indicates moderate-risk potential hazards that, if not avoided, may lead to death or serious injury.



CAUTION

Indicates low-risk potential hazards that, if not avoided, may lead to minor or moderate injury.

1. Safe Introductions

This manual contains important instructions for the charger that shall be followed during installation, operation, and maintenance. Please review all warnings and notices before installing and using the charger.



WARNING

Do not install or use the charger near flammable, explosive, harsh or combustible materials, chemicals, or vapors.



WARNING

Turn off the power supply at the circuit breaker before installing or cleaning the charger.

NOTICE

- Use the charger only within the operation steps and parameters specified in this manual.
- Never spray water or any other liquid directly onto the charger body or the charging connector. Store the charger in the connector socket to prevent unnecessary damage.
- Do not attempt to disassemble, repair, tamper with or modify the charger. Contact DEYE for any repair or modification.
- Do not use the charger if it is defective, appears cracked, frayed, broken or otherwise damaged, or fails to operate. Please contact Deye in time.

Be careful when transporting the charger. Do not subject it to strong force or impact or pull, twist, tangle, drag, or step on the charger to prevent damage to it or any components.

- Do not touch the end terminal of the charger with any part of your body or metal objects.
- Use of charger may affect or impair the operation of any medical or implantable electronic devices, such as implantable cardiac pacemakers or implantable cardi overter defibrillator. Please check with your electronic device manufacturer concerning the effects of the charger on such electronic devices before using the charger.

2. Introduction

2.1 Introduction of installation methods

The charger is used for AC charging of electric vehicles (EV/PHEV) and can be wall-mounted or drag and drop used.

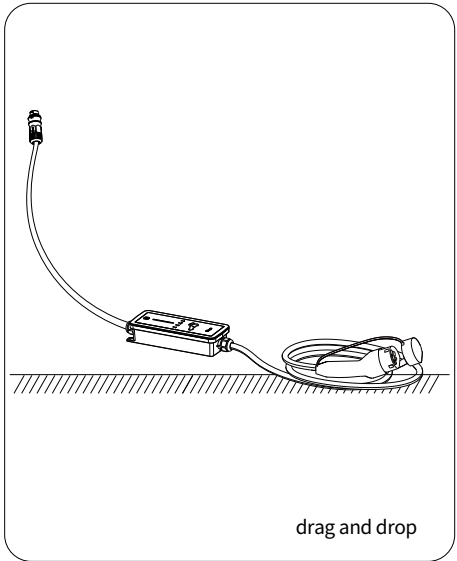
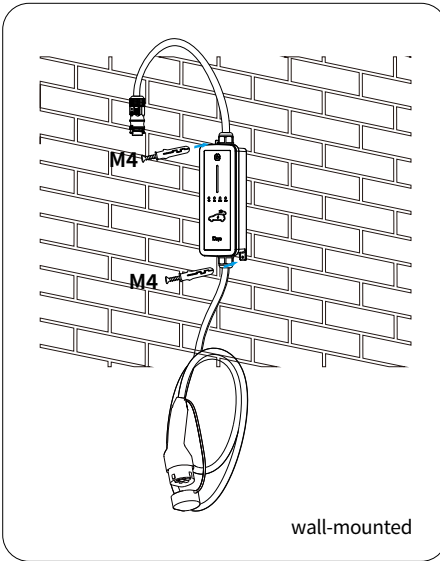

- **Ease of Use**

EV drivers can start and stop charging via LCD screen of Deye hybrid inverter or App. When the vehicle is fully charged, the charging will stop. The charger also supports plug&play charging, which means the charging starts automatically as soon as the charging connector is plugged into the vehicle.

- **Smart and Easy Management**

In addition to the LED lights on the charger that indicate charging status, EV drivers can visualize and control the charging session remotely via Deye cloud or Solarman.

- **Sustainability**

With an IP66 rating, the charger is water and dust proof, allowing for outdoor use and maintenance.

2.2 Model

The charger comes in two versions for different use cases:

SUN-EVSE11K01-EU-AC

SUN-EVSE22K01-EU-AC

2.3 Appearance and Dimensions

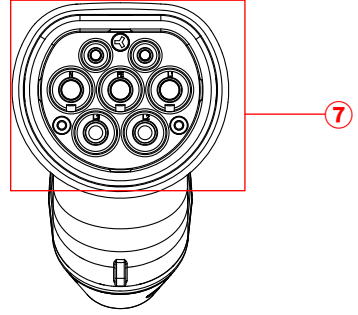
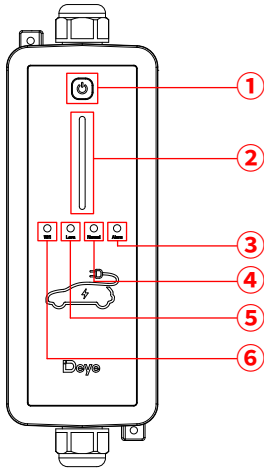

Type 2

1:Function button 3:Alarm indicator

5:Lora indicator 7:Charging gun interface

2:LED strip

4:Normal indicator

6:WIFI indicator

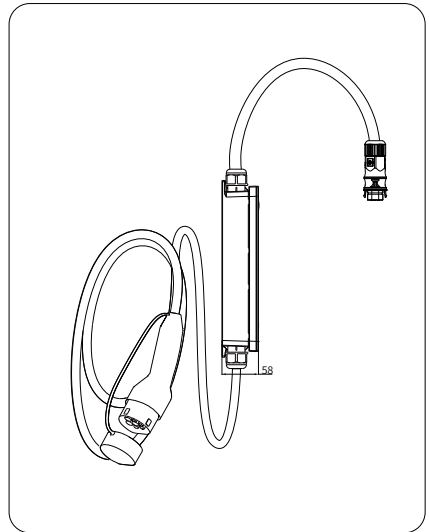
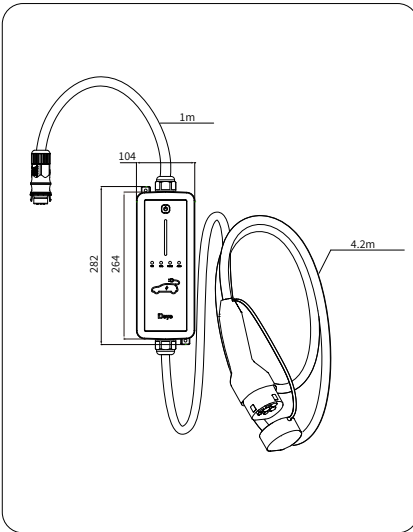

2.4 System Topology

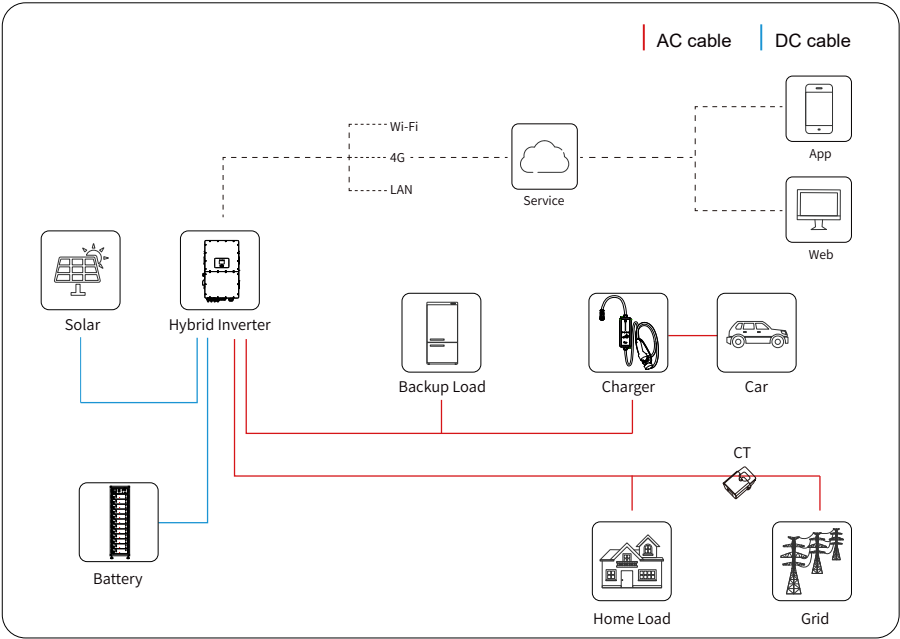

3. Installation

3.1 Introduction

• Location Requirements

Select an optimal mounting location for safe operation, long service life and expected performance.

• Environment Requirements

- There must be no flammable hazards or ignition risks.
- The mounting location must be inaccessible to children.
- The ambient temperature and relative humidity must meet the following requirements.

Operating Temperature Range: -40 ~ +55°C

Permissible Ambient Humidity: 5% ~ 95% No condensation

- Avoid exposure to direct sunlight.
- The charger should be well-ventilated for good air circulation.
- The mounting location must be away from living area. The charger will emit noises during operation that might be perceived as disturbing.

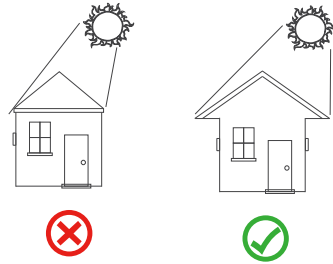
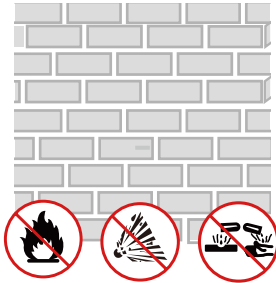

Recommended installation place

3.2 Unpacking and Inspection

Check the equipment before installation. Please make sure nothing is damaged in the package. You should have received the items in the following package:

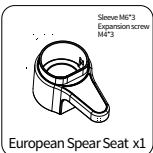
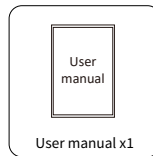
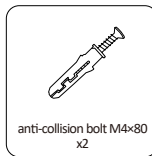
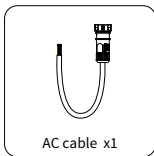
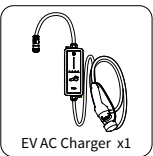

3.3 Installation Tools

Installation tools can refer to the following recommended ones. Also, use other auxiliary tools on site.

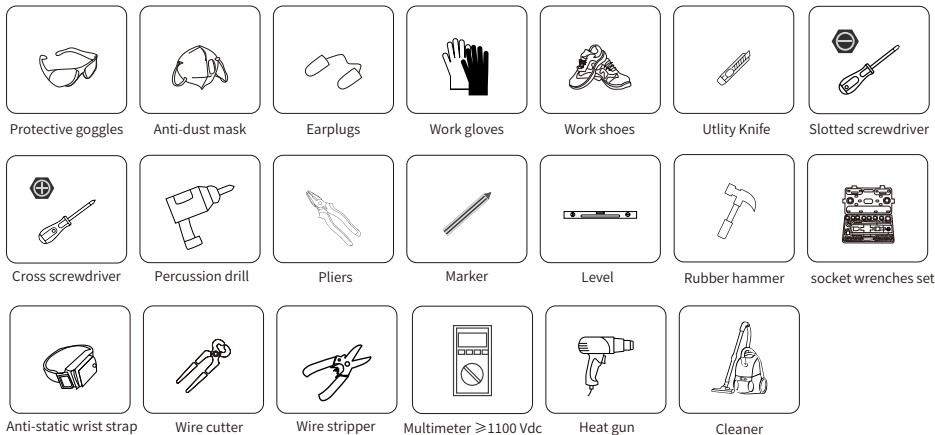

3.4 Electrical Connection

3.4.1 Circuit Diagram

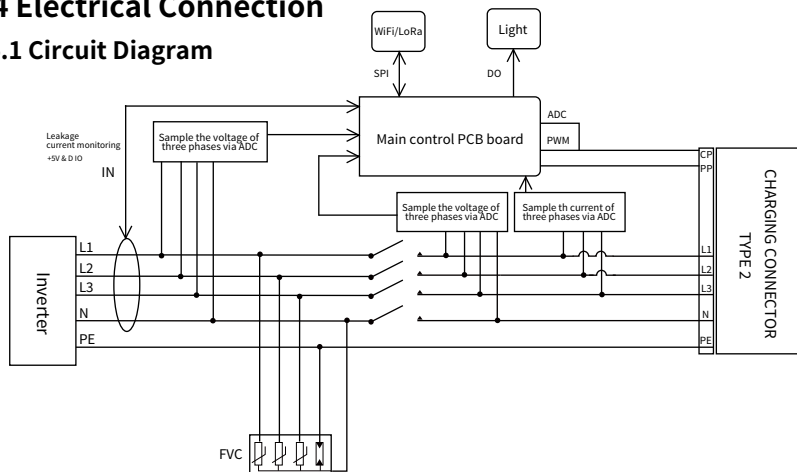

NOTICE

The charger already integrates a DC residual-current device (RCD) with a rated residual-current of 6 mA. However, the charger also requires a type A RCD of 30 mA to operate. Each charger in the system must be individually connected to the utility grid through an RCD and a miniature circuit breaker.

3.4.2 Recommended specification of AC cable and PE

Model	Wire Size	Cross section
SUN-EVSE11K01-EU-AC	14AWG	1.5mm ²
SUN-EVSE22K01-EU-AC	10AWG	4mm ²

Recommended Size for AC Cable and PE

3.4.3 Single phase connection

LOAD

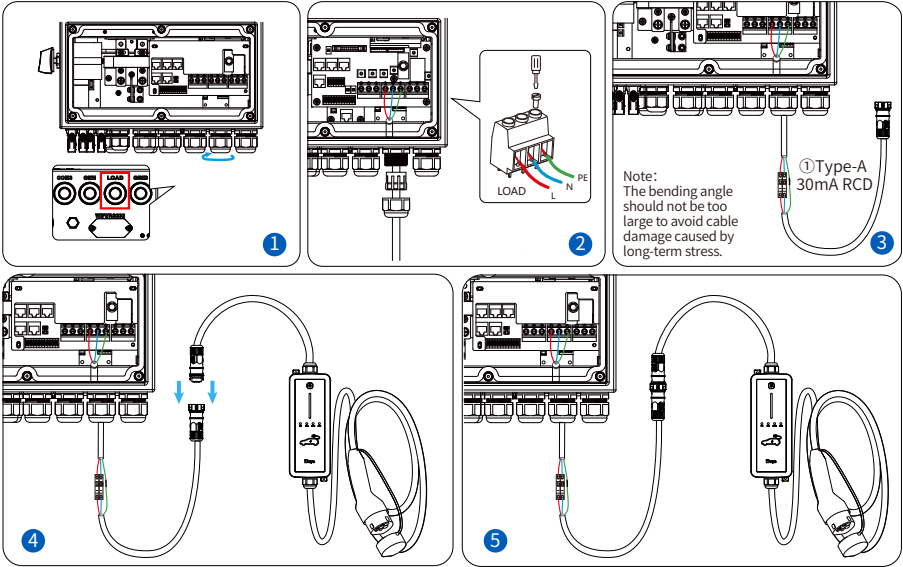

GRID

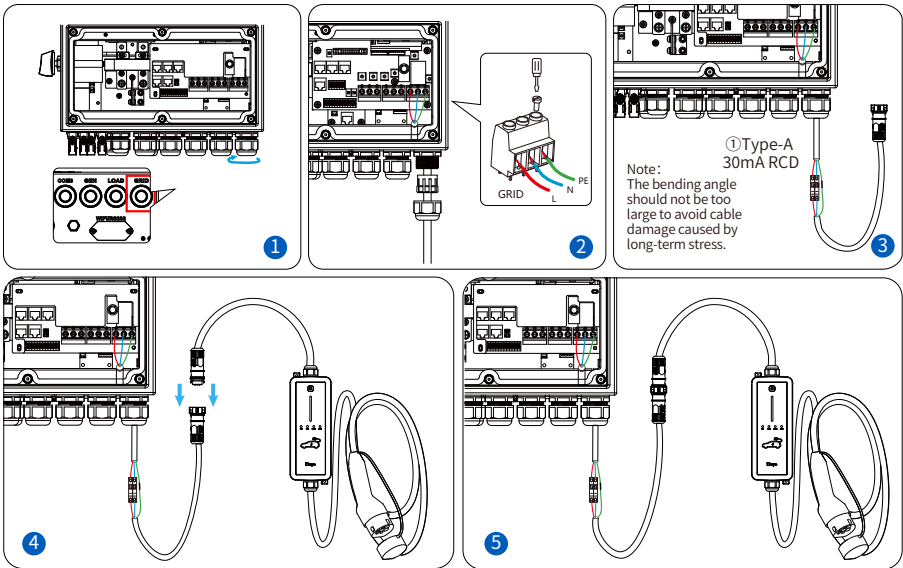

3.4.4 Three phase connection

LOAD

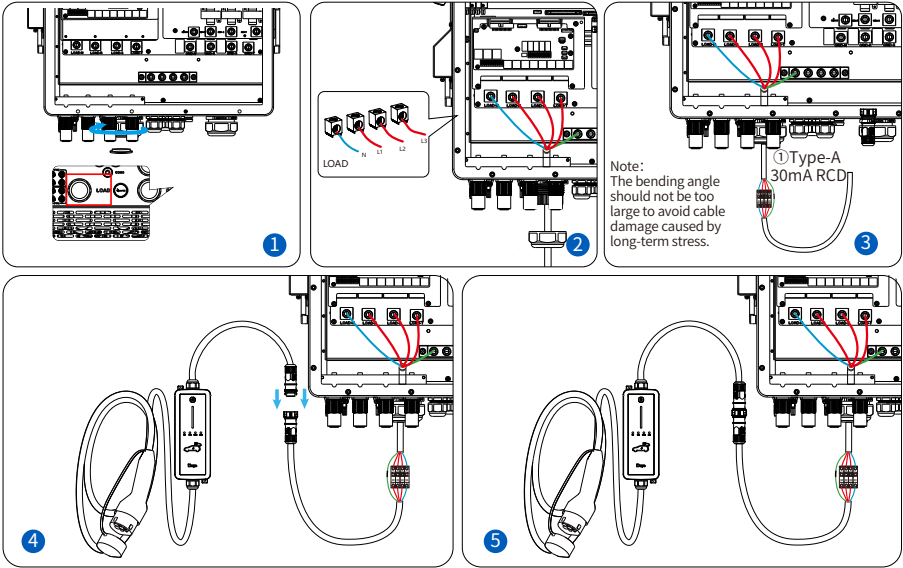

GRID

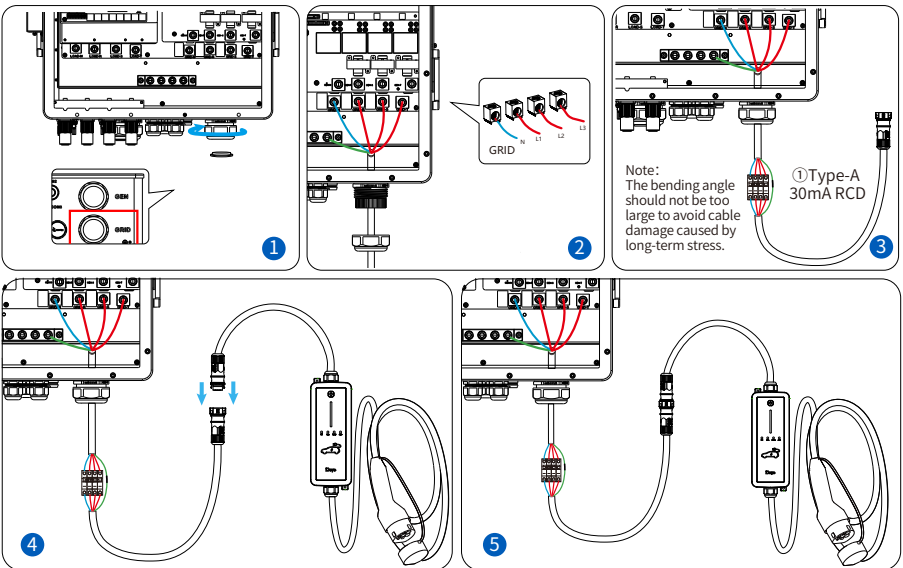

Note: When phase loss occurs on L2 or L3, the EV charger will not alarm

4. Inspection before Commissioning

- **Location**

The charger is correctly mounted at a place that is convenient for operation and maintenance.

- **Charger**

The charger is firmly and securely installed.

- **Cable**

Cables are correctly and firmly connected, and are adequately protected from damage.

- **Clearance**

The charger has sufficient cooling space and there is no other stuff or components are left on the top of the charger.

1. Ensure that all requirements are met before commissioning.
2. Power on the charger.
3. Check the status of the indicators and confirm if this EV charger is operating properly.

Indicator	Status	Meaning
Wi-Fi (Green LED)	Blink once per second during the process of sending and receiving messages.	Wi-Fi communication is normal
	OFF	No Wi-Fi communication
LoRa (Green LED)	Blink once per second during the process of sending and receiving messages.	LoRa communication is normal
	OFF	No LoRa communication
Normal (Yellow LED)	ON	No alarm occurred
	OFF	EV charger is unnormal, like the power supply is interrupted
	Blink one time during the intervals of the alarm light cycle	A malfunction has occurred
Alarm (Red LED) Note: From F1 to F11, the priority decreases sequentially. When multiple faults occur simultaneously, the fault code with the highest priority will be displayed.	Normal indicator blink one time → Alarm indicator blink one time → Normal indicator blink one time again. Cyclic	F1 overcurrent fault occurred
	Normal indicator blink one time → Alarm indicator blink two times → Normal indicator blink one time again. Cyclic	F2 overvoltage fault occurred
	Normal indicator blink one time → Alarm indicator blink three times → Normal indicator blink one time again. Cyclic	F3 undervoltage fault occurred
	Normal indicator blink one time → Alarm indicator blink four times → Normal indicator blink one time again. Cyclic	F4 leakage current fault occurred
	Normal indicator blink one time → Alarm indicator blink five times → Normal indicator blink one time again. Cyclic	F5 Short circuit occurred in the guiding circuit
	Normal indicator blink one time → Alarm indicator blink six times → Normal indicator blink one time again. Cyclic	F6 Relay fault occurred
	Normal indicator blink one time → Alarm indicator blink seven times → Normal indicator blink one time again. Cyclic	F7 Charging circuit fault occurred
	Normal indicator blink one time → Alarm indicator blink eight times → Normal indicator blink one time again. Cyclic	F8 Overtemperature fault occurred
	Normal indicator blink one time → Alarm indicator blink nine times → Normal indicator blink one time again. Cyclic	F9 Low temperature warning
	Normal indicator blink one time → Alarm indicator blink ten times → Normal indicator blink one time again. Cyclic	F10 Grounding fault
	Normal indicator blink one time → Alarm indicator blink eleven times → Normal indicator blink one time again. Cyclic	F11 Lora communication fault
	OFF	Normal

Indicator	Status	Meaning
LED strip(tri-color LED)	Displaying a blue breathing light effect	Charging in 'plug and play' mode
	Displaying a green breathing light effect	Charging in 'Time of charge' mode
	Displaying a white breathing light effect	Updating
	Displaying a Purple breathing light effect	Enter channel scanning mode
	Red LED light is on	Emergency stop (The relays will disconnect)
	OFF	idle or A malfunction has occurred
Buzzer	Make a sound	Any faulty occurring
	Not making any sound	Normal
Function button	Press and hold the button for at least 1 second until the LED strip turns purple.	Enter channel scanning mode
	LED strip: Blue/Green $\xrightarrow{\text{Short press the button}}$ LED strip turns Red	Emergency stop
	LED strip: Red $\xrightarrow{\text{Short press the button}}$ LED strip turns back to Blue/Green	Restore to the previous working state

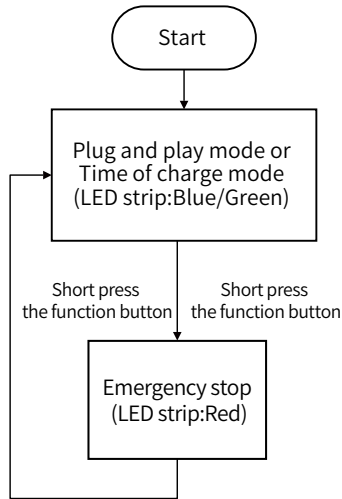

5.WiFi and Lora configuration

5.1 WiFi configuration

This series EV charger has built-in WIFI module(with Bluetooth function) which is able to connect router directly. For WIFI configuration, the following two methods are recommended.

5.1.1 WiFi configuration via APP

Step 1: Tap on “” icon in the upper right corner of Deye cloud APP, select “Wi-Fi configuration” and automatically jump to the page for scanning nearby devices;

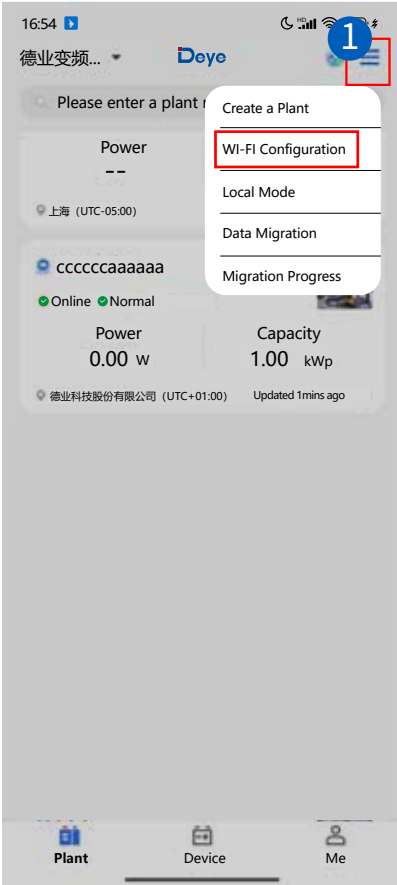

Step 2: Select the AP hotspot of inverter's built-in WiFi module;
Step 3: Select an available 2.4G network, enter it's password and tap on "Next";



Step 4: Wi-Fi configuration is in process (Please don't leave this page and place your phone near the devices);

Step 5: After Wi-Fi configuration done, you could enter a personalized device name and tap on "Complete" to end the configuration.

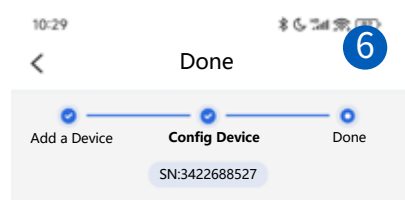

WiFi configured successfully

Please place your phone near the devices



The distribution network lasts about 1-5 minutes, do not leave this interface until the network is successfully connected

Please enter a personalized device name

Complete

5.1.2 WiFi configuration via localhost

For this method, please scan the QR code below to download the corresponding reference document.

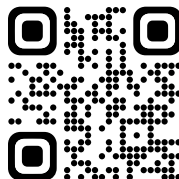

Webpage monitoring address: <https://www.deyecloud.com>.

For mobile phone monitoring system, scan the QR code below to download the APP.

Also you can find it by searching “deye cloud” in App store or Google Play store, and this App is for distributor/installer.



Deye Cloud

All in one, Efficiency



Scan QR code to download APP

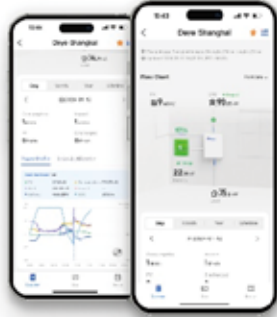

5.2.Lora configuration

5.2.1 Steps to establish Lora communication

Step1: Bind the EV charger to the inverter.

Method 1:

1. Enter the Main screen of inverter’s LCD.Click on the gear icon in the upper right corner of the screen to enter the ‘System Setup’ page.

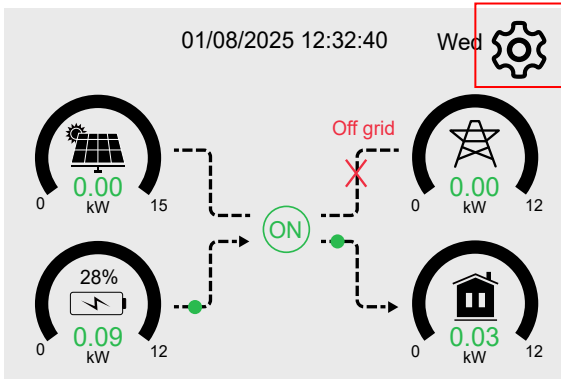

2. Click on the 'Smart Devices' item on the 'System Setup' page to enter the 'Smart Devices' page.

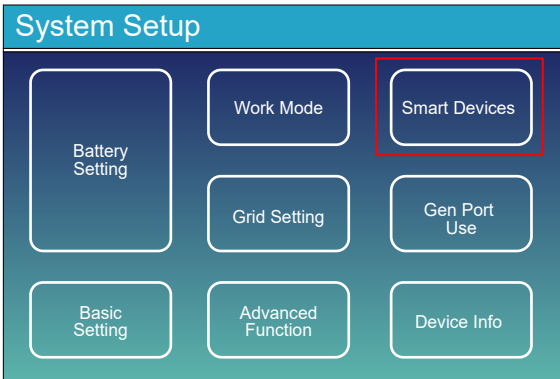

3. Click on the "Smart EV Charge" icon to enter the parameters page of EV Charger.

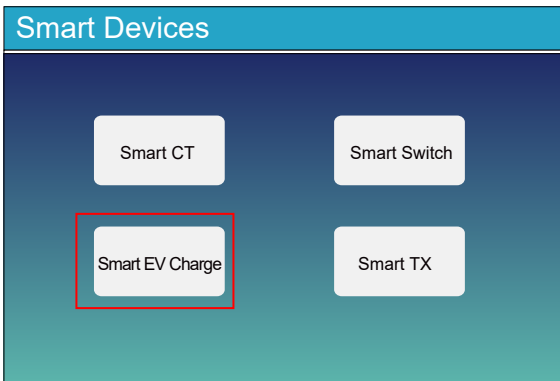

4. Click the long textbox before the "Enable" checkbox to enter the 'SN input' page.

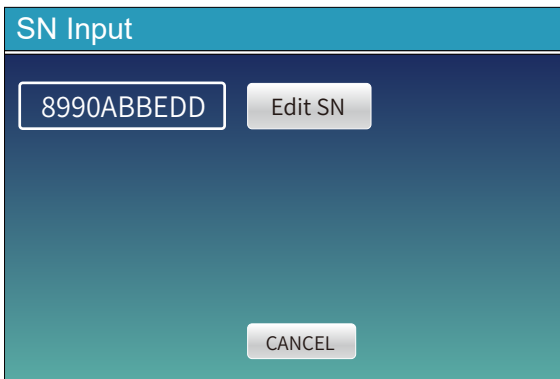

5. Click the 'Edit SN' button and then click the 'OK' button on the 'SN input' page, the soft keyboard will display on the screen for you to type in the serial number (SN) of the EV charger, its series number can be found on its label.

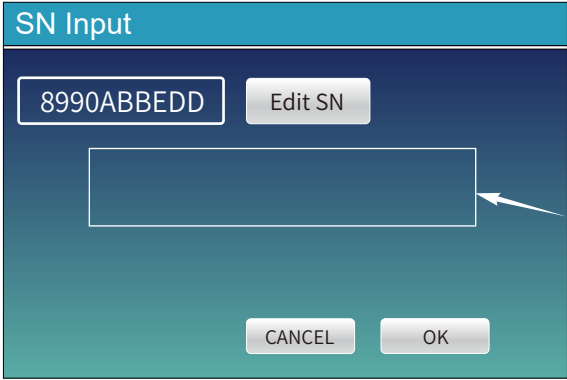

Editing a new SN may result in the loss of the old SN, please operate with caution!

6. After completing the input and confirming it is correct, click "OK" to save the setting. Click the "DEL" button to delete incorrect data, and click the "CANCEL" button to cancel editing and exit.

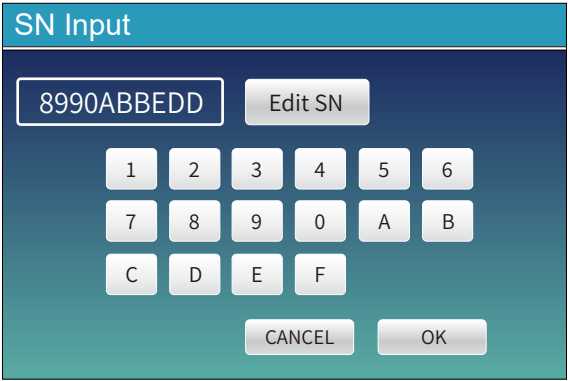

Method 2:

1. Click on the plant that needs to add an "EV Charger" on the plant listpage to enter the "Overview" page of the plant

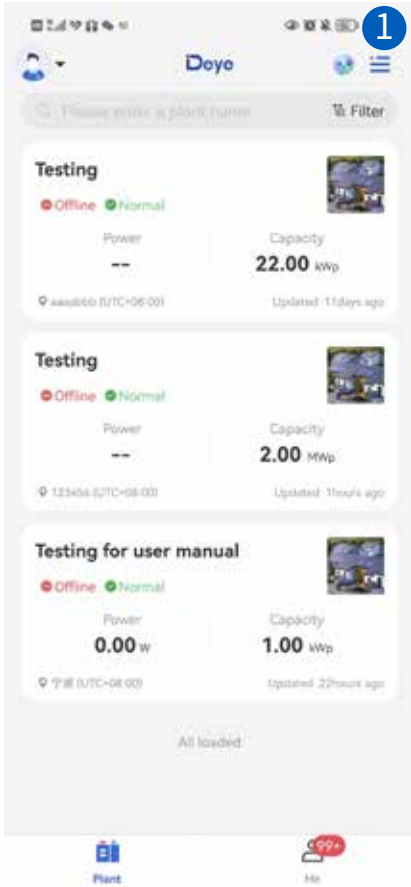

2. Click on the "Device" item in the bottom right corner of the "Overview" page to enter the "Device" page



3. Click on the blue "Smart Devices" item in the middle of the "Inverter" page to enter the "Bind a Lora Device" page



4. Click on the "+" icon in the bottom right corner of the page to enter the "Scan SN" page.



5. Scan the QR code corresponding to the SN information of the EV charger according to the prompts on this page. You can also click on the "Enter SN" icon in the bottom left corner of the page to enter the manual SN input page.



6. Manually enter the SN of the EV Charger, then click the "Confirm" button to confirm and complete the input.

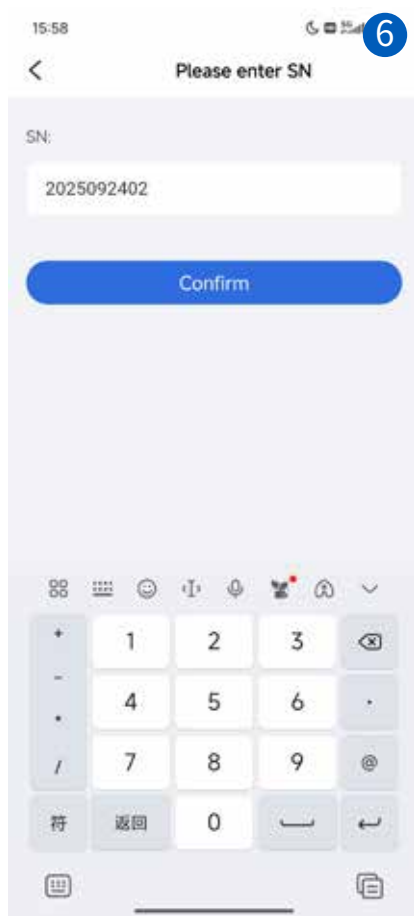

7. Select 'Device Type' as 'EV Charger', then click the "Confirm" button to confirm and complete the binding.

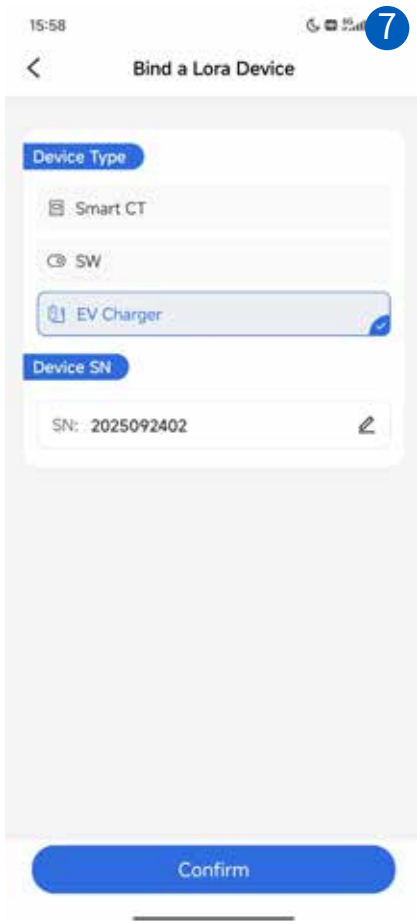

8. After completing the binding, the following message will pop up indicating successful binding.

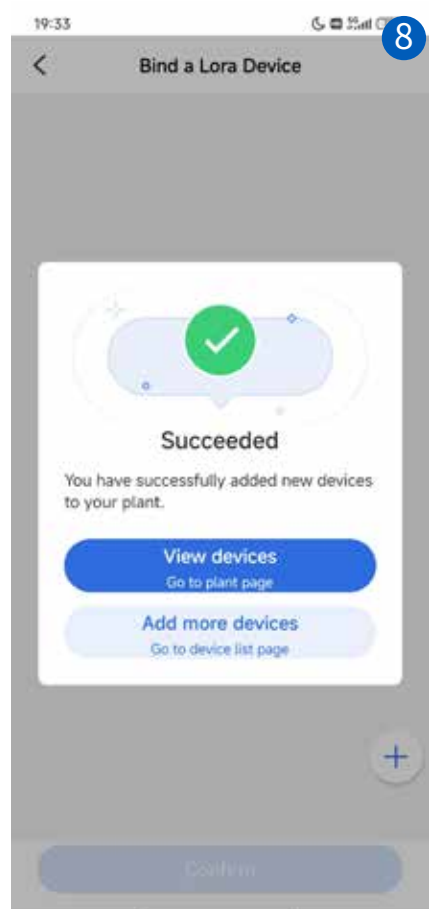

Step 2: Enable the EVcharger and conduct communication channel scanning

After correctly inputting the SN of the EV charger and enabling the charger (as shown in Figure 5.2-1) , press and hold the button(as shown in Figure 5.2-2)on EV charger body until its LED strip turns purple to enter channel scanning mode. Channel search completed, purple breathing light disappears. LoRa indicator starts flashing. On the inverter ON interface, the charging pile displays green.

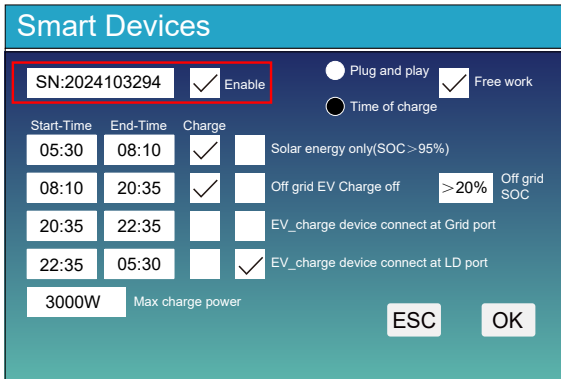

Figure 5.2-1

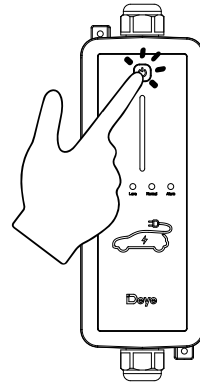

Figure 5.2-2

In Lora communication mode, the EV charger can work normally until the hybrid inverter has sent "Max charge power" to the EV charger after starting or restarting it.

5.2.2 Adjustment of Lora communication channel

There are several ways to adjust the Lora communication channel of EV charger:

Method 1: Adjust it on the localhost page of the built-in WiFi module of EV charger (as shown in Figure 5.2-4), and please refer to chapter 5.1.2 for the method of entering the localhost of EV charger.

Method 2: Refer to Chapter 6 to set the working mode (communication mode) of EV charger to WiFi mode, and then adjust its communication channel (communication frequency) on the webpage or APP of the cloud platform (as shown in Figure 5.2-5).

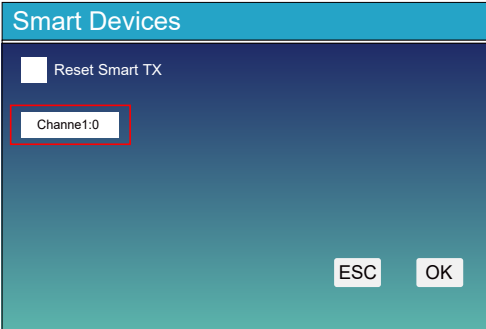

Figure 5.2-3

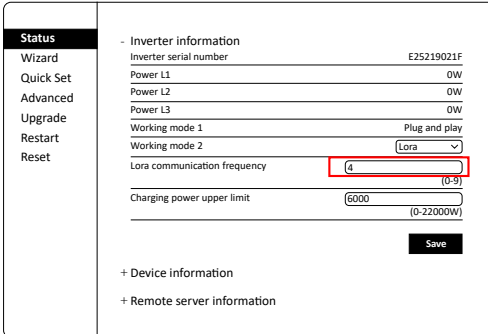

Figure 5.2-4

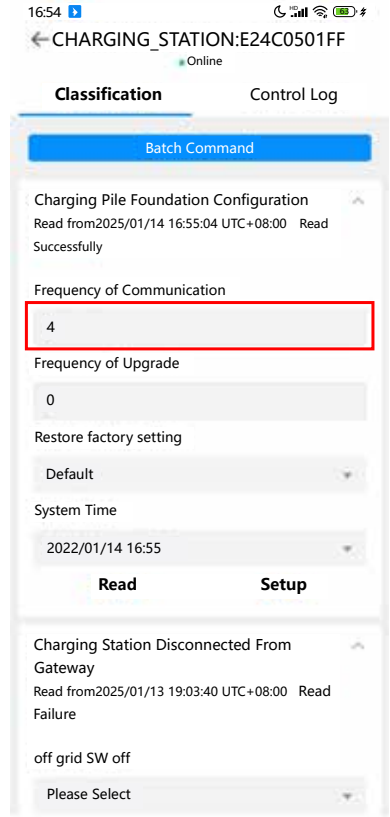

Figure 5.2-5

6. Setting of communication mode

This EV charger has two kinds of communication mode: WiFi mode and Lora mode.

WiFi mode: Using the built-in WiFi module of EV charger, upload the operational data of EV charger to the cloud platform directly, or send command to the EV charger through the cloud platform's webpage.

Lora mode: Pair the built-in Lora module of EV charger with the smart TX master node of the hybrid inverter, and then upload the operational data of EV charger or receive the control commands through the Lora module of EV charger. This is the default communication mode.

There are following several methods to switch the communication modes:

Method1: Switch the communication mode through the localhost of EV charger's built-in WiFi module.

step 1: Refer to chapter 5.1 to complete the WiFi configuration.

step 2: Use the mobile devices like smart phone or laptop to connect the AP hotspot of EV charger, the name of the AP hotspot is like AP_*** (***) means SN of EV charger's WiFi module, as shown in figure 6.1).

step 3: Log in the localhost of EV charger's AP hotspot: 10.10.100.254, user name: admin, password: admin.

step 4: You can select the desired communication mode from the drop-down list of the "Working mode 2" sub item on the "Status" page, as shown in Figure 6.2

Status	
Wizard	- Inverter information
Quick Set	Inverter serial number E25219021F
Advanced	Power L1 0W
Upgrade	Power L2 0W
Restart	Power L3 0W
Reset	Working mode 1 Plug and play
	Working mode 2 WiFi
	Lora communication frequency <input type="text" value="5"/> WiFi
	Charging power upper limit <input type="text" value="6000"/> Lora
	(0-22000W)
	<input type="button" value="Save"/>
	+ Device information
	+ Remote server information



SN of WiFi module

Figure 6.1

Figure 6.2

Method 2: Switch the communication mode through the webpage or APP of the cloud platform, as shown in Figure 6.3

Method 3: The other communication mode switching methods, like through LCD of the hybrid inverter, are still under development.

As shown below, different scenarios support different communication modes:

Scenario 1: No hybrid inverter, connect to other AC power sources for separate use. In this scenario, only support WiFi mode, but due to the default communication mode is lora mode, it's necessary to first change the communication mode through the aforementioned method 1.

Scenario 2: Connect to the Grid/Load port of the hybrid inverter. In this scenario, both WiFi mode and Lora mode are supported.

Figure 6.3

7. Local control mode

7.1 Explanation of parameters

Start Time	End Time	Charge	
④ 05:30	⑤ 08:10	<input checked="" type="checkbox"/>	<input type="checkbox"/> Solar energy only(SOC>95%)
⑤ 08:10	⑥ 20:35	<input checked="" type="checkbox"/>	<input type="checkbox"/> Off grid EV Charge off <input type="checkbox"/> Off grid SOC >20%
⑥ 20:35	⑦ 22:35	<input type="checkbox"/>	<input type="checkbox"/> EV_charge device connect at Grid port
⑦ 22:35	④ 05:30	<input checked="" type="checkbox"/>	<input type="checkbox"/> EV_charge device connect at LD port

Click on 'Smart EV charge' item in the down left corner of 'Smart Devices' page to enter the left page.

After checking the CheckBox in the upper left corner of the page, you can follow the steps below to enter the series number of the EV charger.

Plug and play: The EV charger will operate like a common load, without the need to follow programmable schedule settings.

Time of charge: Control the use of EV charger according to the programmable schedule. 24 hours a day will be divided into four time periods (only the fourth period can pass midnight), and whether

to use the EV charger to charge the electric vehicle during each time period can be controlled separately.

Solar energy only(SOC>95%): Only when the SOC of the battery rises to 99%, the excess solar energy from the hybrid inverter can be used to power the EV charger. If the SOC of the battery drops below 95%, the EV charger will shut down. In addition, even without sufficient solar energy, the minimum charging current of EV charger will be limited to 6A.

Free work: The AC power output from the inverter module (from solar power and battery discharging power) and the AC power input from the bypass circuit can both be used to power the EV charger.

Off grid EV Charge off: When the hybrid inverter switches to off-grid mode and the SOC of the battery isn't bigger than the set value of 'Off grid SOC', the EV charger will be automatically turned off.

Off grid SOC: When the hybrid inverter switches to off-grid mode, the EV charger will keep operating if the SOC of the battery is bigger than this set value.

EV_charge device connect at Grid port: The EV charger is connected to the Grid port of the hybrid inverter.

EV_charge device connect at LD port: The EV charger is connected to the Load port of the hybrid inverter.

Max charge power: The maximum charging power allowed in both 'Plug and play' mode and 'Time of charge' mode.

Set the parameters of EV charger on the LCD of the inverter

①: Type the SN number of EV charger into the textbox in zone 1.

②: Check or uncheck to enable or disable the EV charger.

③: Check or uncheck to determine whether to use the EV charger to charge the EV during the current time period or not.

④: The start time of the first time period and the end time of the fourth time period.

⑤: The start time of the second time period and the end time of the first time period.

⑥: The start time of the third time period and the end time of the second time period.

⑦: The start time of the fourth time period and the end time of the third time period.

7.2 View operating status via LCD

1. Click the circle on the center of LCD's main screen.

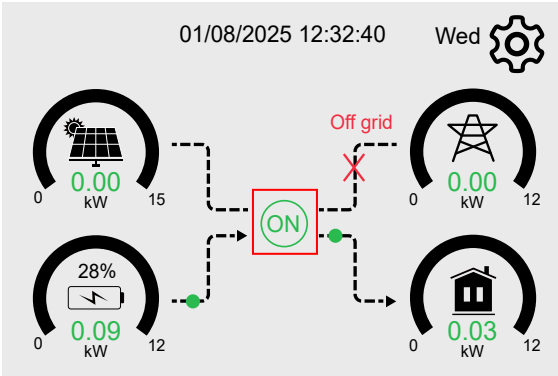

2. After the screen jumps to the page below, press the 'UP' or 'Down' button to enter the next page.

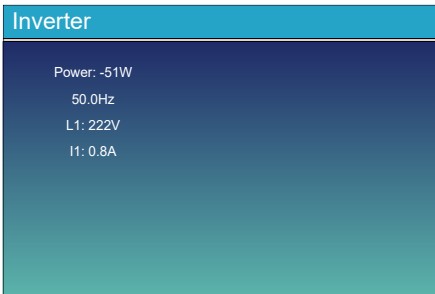

Single phase hybrid inverter

27 W	0 W 0.0 Hz	27 W 50.0 Hz
230V 10W 228V 0W 229V 10W	0V 0.0A 0V 0.0A 0V 0.0A	230V 0.0A 230V 0.0A 230V 0.0A
Load	HM: LD:	INV_P:
SOC:28% 94W	0W 0W 0W 0W	10W 7W AC_T: 10W 41.0 C
BAT_V:50.69 V 1.87 A 22.4 C	Grid	Inverter
Battery	DC_P1: 0W DC_V1: 0V DC_I1: 0.0A	DC_P2: 0W DC_V2: 0V DC_I2: 0.0A
	PV1	PV2

Three phase hybrid inverter

3. In this detail information page of smart devices, you can check the operating status of EV charger at current time. There are three scenarios as below:

- (1) Normally operating: the icon of EV in the upper right corner of this page is green and the charging power at current time is displaying.
- (2) If the icon of EV in the upper right corner of this page is gray, which means the EV charger fails to communicate with the inverter. Please back to the parameters setting page of EV charger to check these items: Whether the SN of EV charger in text box is correct; Whether the EV charger has been enabled. Whether the communicating channel of smart TX is channel 6 (The default communicating channel of EV charger is channel 6).
- (3) Alarm : the icon of EV in the upper right corner of this page is red and the fault code is displaying.

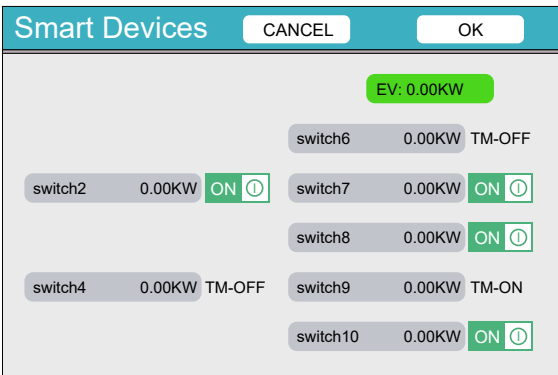

8. Remote control via APP

1. Find out the solar plant which the EV charger is bound in the plant list of the APP.

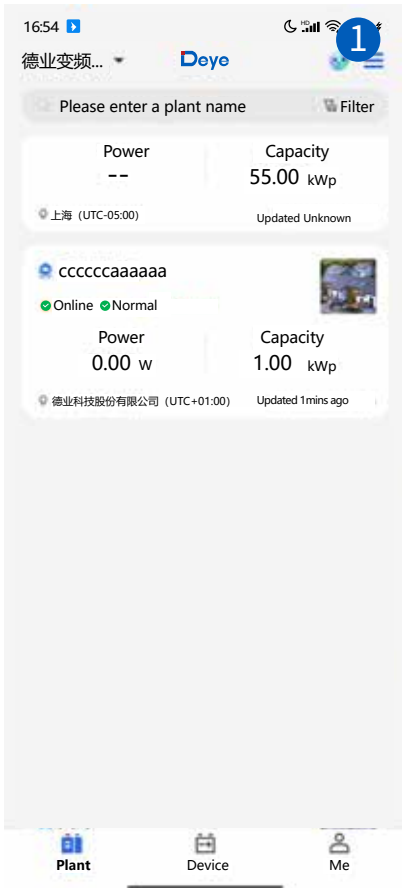

2. After entering the overview page of the solar plant, you can find the icon of EV charger inside the power flowing diagram.

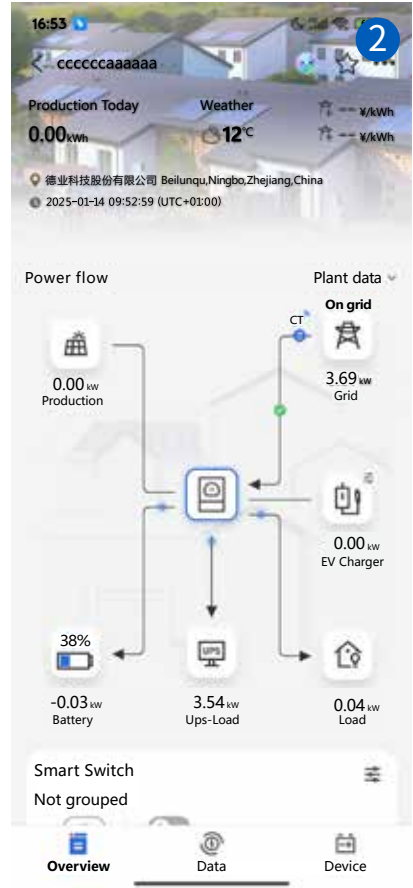

3. Click the icon of EV charger inside the power flowing diagram, the APP will turn to the operation status page of EV charger. And you can also change the settings of EV charger in this page. All these parameters are the same with the parameters on the LCD of inverter, please check the parameters explanation on chapter 7.1

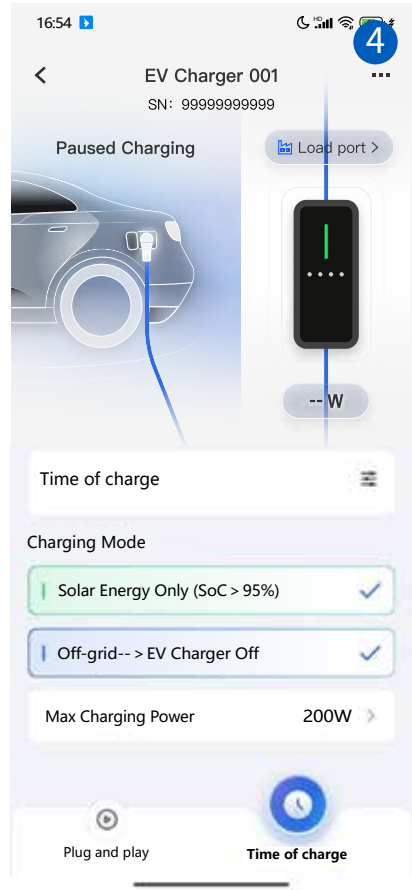
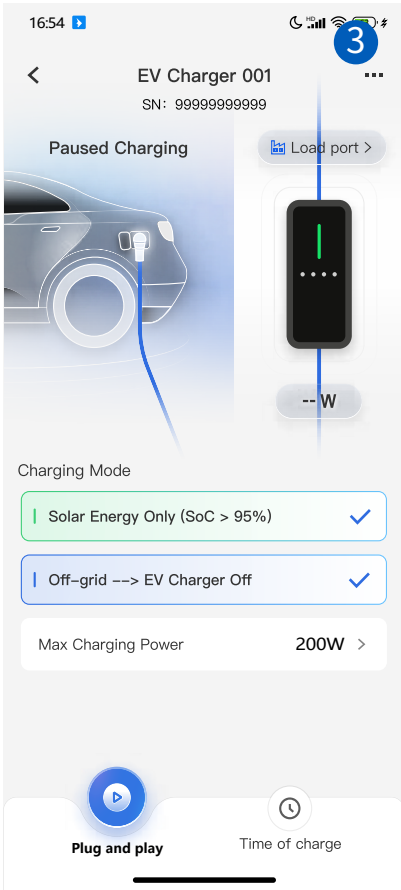

- Back to the overview page of the solar plant, and then click the “Devices” item on the down right corner of overview page to enter the Device page.

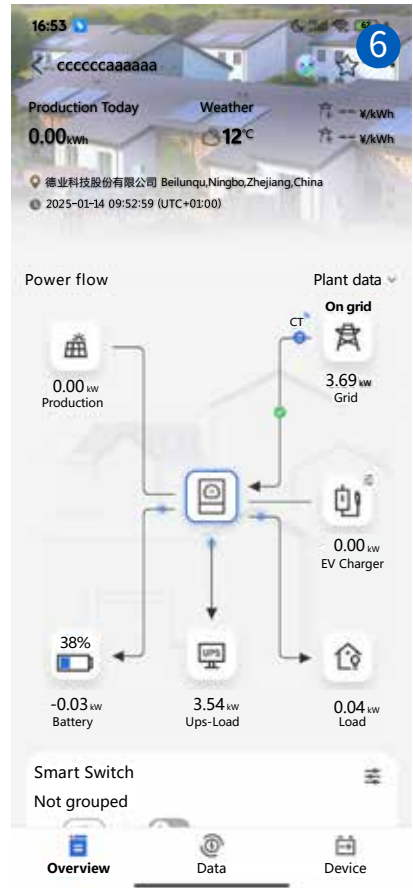
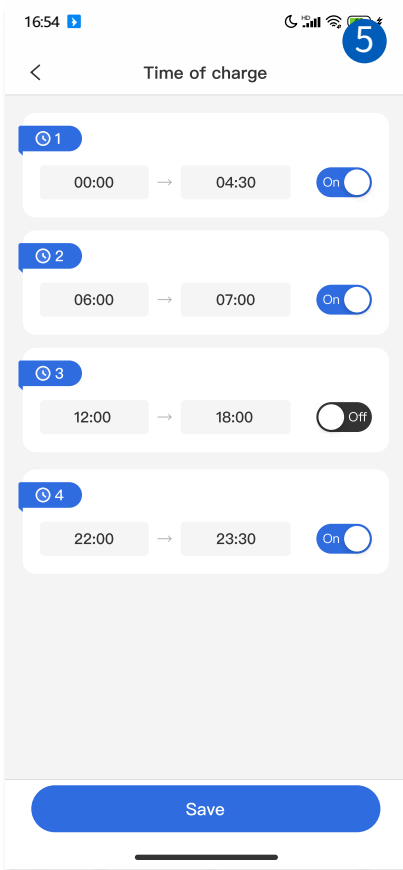

- On the Device page, you can find the EV charger you need to set. Click the item of the corresponding EV Charger to enter its “Device Data” page. On this page, you can see the following information: Nameplate value, Basic Information, Version Information, Charging Information.

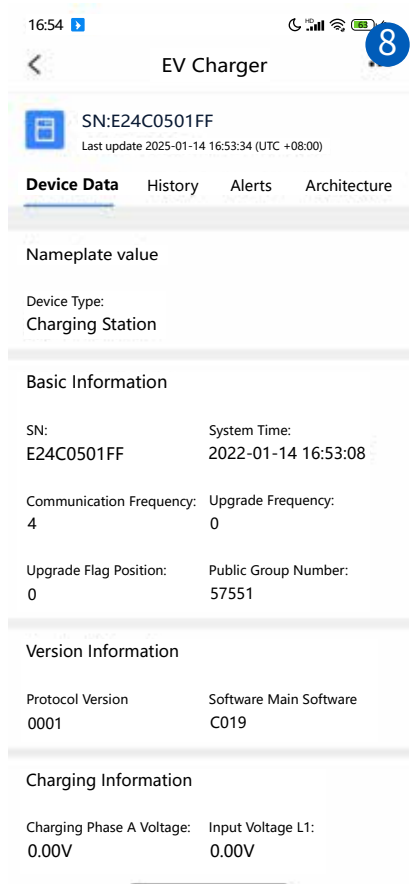
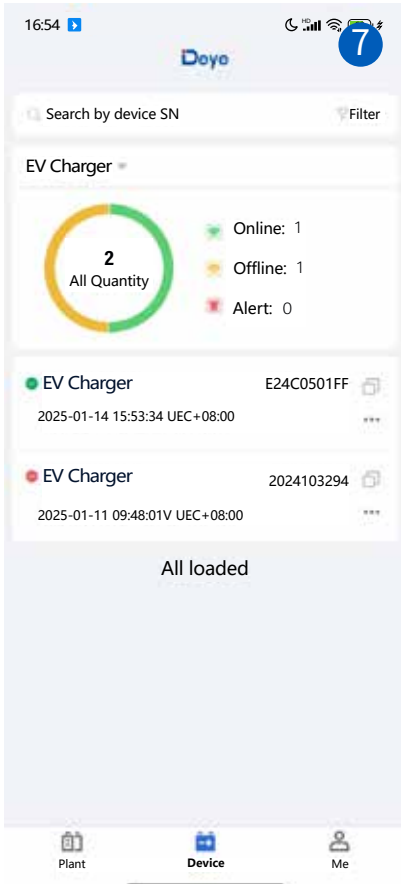

6. On the menu line of “Device Data” page, click “History” to enter the page for displaying and querying historical information. Historical data can be presented in different time periods, such as day, month, year, and lifetime, after you have clicked the corresponding time item.

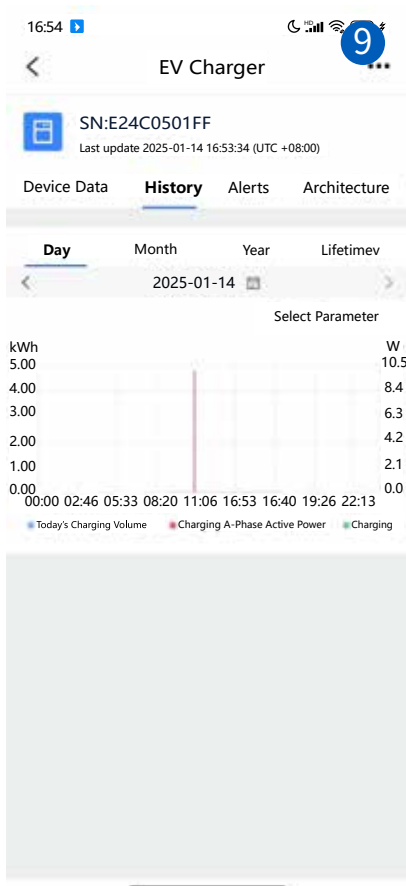

7. Click on “Select parameter” in the upper right corner of the data chart, you can choose the parameters wanted to display in the data chart on the pop page.

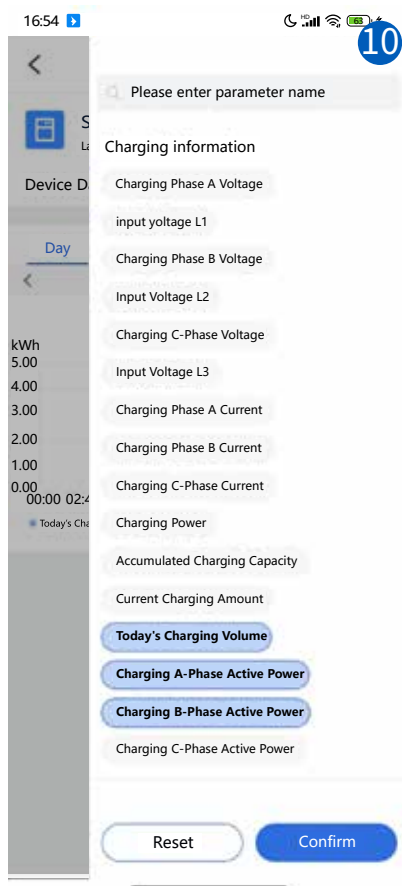

8. Click "Alerts" item on the menu line to enter the Alerts information page.

9. Click "Architecture" item on the menu line to check the Parent Device of this EV charger.

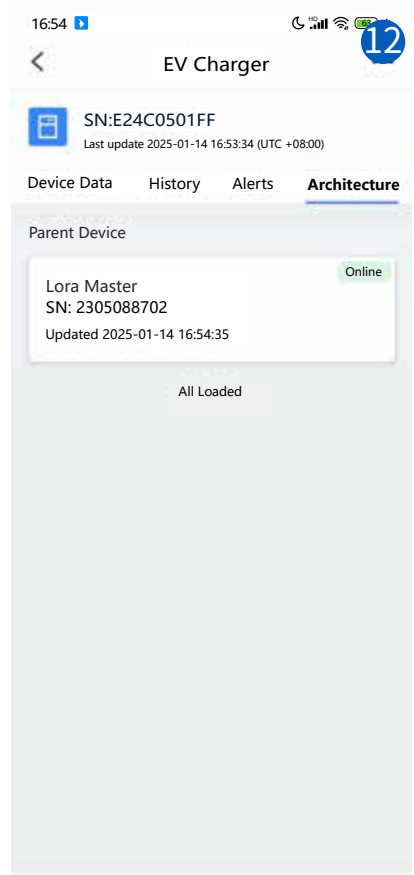
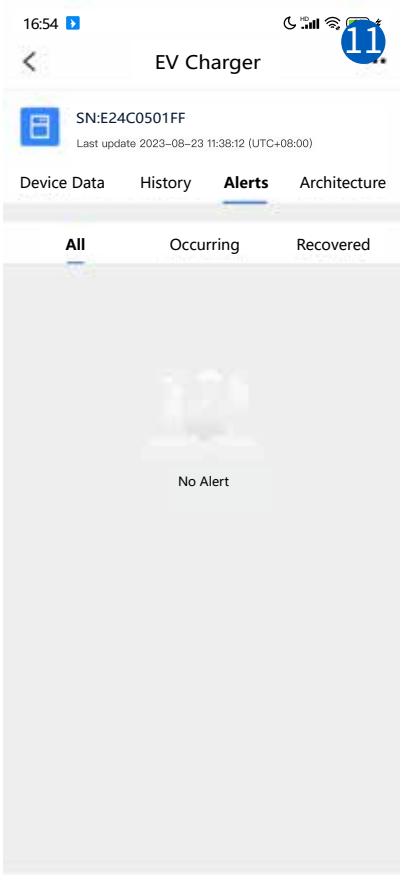

10. Click the "... " icon on the up right corner of the APP, and then select the "Remote control" option on the pop menu to enter the "Classification" page.

11. There are two subordinate pages for Remote control, and on the "Classification" page, you can set the parameters below.

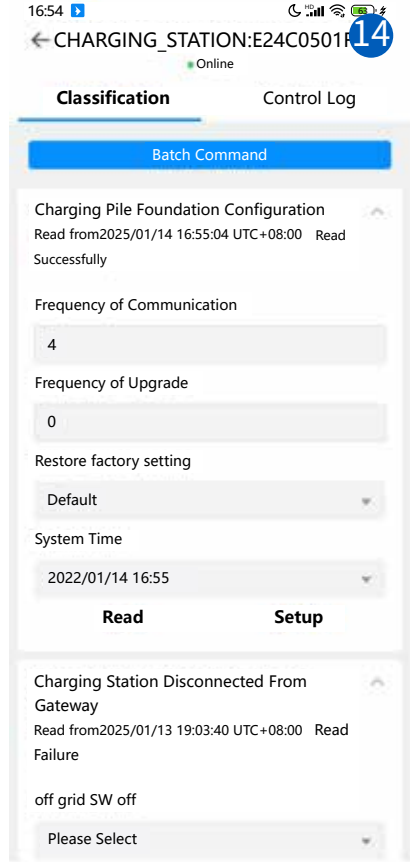
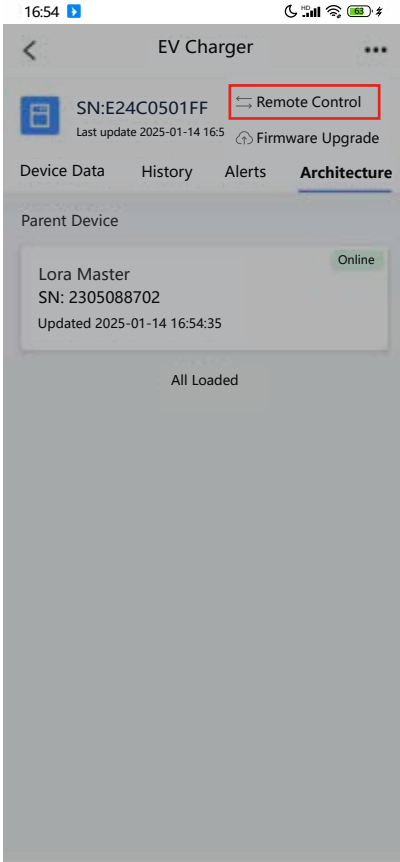

Frequency of Communication: Choose the communication channel(frequency) for the EV charger to communicate with Lora master of hybrid inverter.
Frequency of Upgrade: Choose which communication channel(frequency) to use to upgrade the firmware of EV charger.
Restore factory setting: Restore all parameters of EV charger to the default values of the firmware.
System Time: Change the system time of EV charger.
Off grid SW off: Automatically turn off the EV charger when the inverter switches to off grid mode.

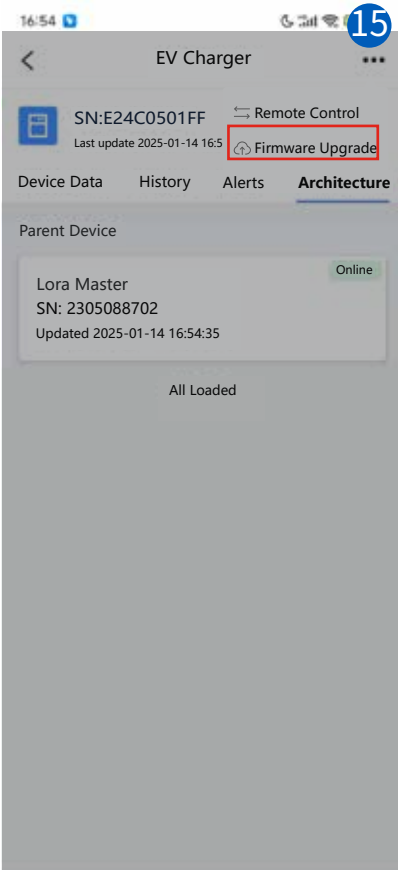

12. Click the “Firmware Upgrade” button on the up right corner of the “Classification” page to enter the Page below. In this page, you can find the current firmware information of EV charger. In the Upgrade operation zone, you can select the firmware package which is used to upgrade the firmware of EV charger, and then click the button “Start to upgrade” to conduct the upgrading process. “Timeout time “ is the time upper limit for firmware upgrade, default value 40, range: 0~60.

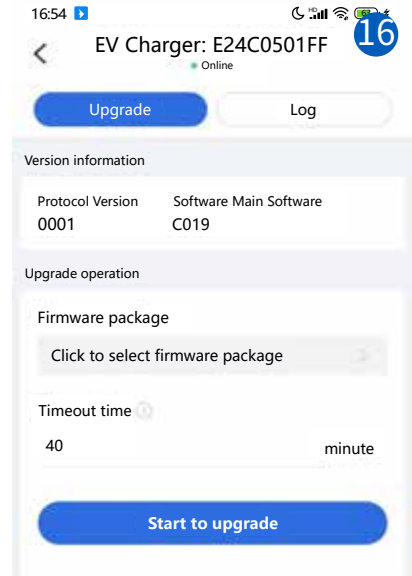

Work Mode: Choose the work mode between “Plug and Play”, “Time of Charge”.

Equipment Working Mode: Optional mode includes: Lora mode and WiFi mode. In Lora mode, remote commands are sent to the inverter through its logger, and the inverter then sends them to the EV charger through Lora communication. In wifi mode, remote commands are directly send by the cloud platform to the built-in wifi module of EV charger

Charge 1/2/3/4 and Working Time Point 1/2/3/4 are corresponding to the parameters under time of charge mode on the LCD.

9. Troubleshooting

Error		Message	Solution
Wi-Fi(Green LED) indicator is OFF		No Wi-Fi connection	<ol style="list-style-type: none"> 1. Confirm if the Wi-Fi network of EV charger has been configured. If not, the network needs to be configured. 2. Confirm if the Wi-Fi signal of the router at the installation location of EV charger is weak due to distance or excessive obstacles, if so, please shorten the distance or increase a signal booster.
LoRa(Green LED) indicator is OFF		No LoRa connection	<ol style="list-style-type: none"> 1. Confirm whether the hybrid inverter has started up normally,if not,please wait for the LoRa module of inverter to start up. 2. Confirm that the SN of EV charger has been added to the smart device page of the inverter, and that the LoRa communication connections between other smart devices and the hybrid inverter are normal.If the EV charger has been added and the other smart devices can communicate with inverter normally, then maybe the LoRa module is fault or damaged. 3. Restart the EV charger,if Lora communication still can not be normal,please contact Deye support team for repairing or replacing.
Alarm(Red LED)indicator is blinking	F1	<p>The actual charging current of EV AC charger is greater than the charging current upper limit sent by the hybrid inverter, and last for more than 5 seconds.</p> <p>Possible reasons:</p> <ol style="list-style-type: none"> 1. Hardware issues with electric vehicle charging circuits. 2. The built-in current sampling circuit of EV AC charger is faulty. 	<ol style="list-style-type: none"> 1.Unplug and re-plug and the EV charger connector. 2.Increase the upper limit of charging current. 3.Replace the built-in PCB of EV charger's wall box
	F2	<ol style="list-style-type: none"> 1.The input voltage exceeds the upper limit(default value is 266.5V). 2.The voltage sampling circuit is faulty. 	<p>In idle state, after the voltage returns to the normal range 182-266.5V, the charger will return to normal. If this fault occurs during the charging process and the voltage returns to the normal range, the charger needs to be unplugged and plugged in again to resume normal operation.If the problem occurs repeatedly:</p> <ol style="list-style-type: none"> 1. Check if the input voltage of EV charger is really too high or the upper limit of input voltage is too low. 2. Properly increase the upper limit of the input voltage and ensure the input voltage is in reasonable range. 3. Replace the built-in PCB of EV charger's wall box.
	F3	<ol style="list-style-type: none"> 1.The input voltage is below the lower limit (default value is 182V). 2.The voltage sampling circuit is faulty. 	<p>In idle state, after the voltage returns to the normal range 182-266.5V, the charger will return to normal. If this fault occurs during the charging process and the voltage returns to the normal range, the charger needs to be unplugged and plugged in again to resume normal operation. If the problem occurs repeatedly:</p> <ol style="list-style-type: none"> 1. Check if the input voltage of EV charger is really too low or the lower limit of input voltage is too high. 2. Properly decrease the lower limit of the input voltage and ensure the input voltage is in reasonable range. 3. Replace the built-in PCB of EV charger's wall box.

Error		Message	Solution
Alarm(Red LED)indicator is blinking	F4	1.More than 6 mA continuous residual current is detected. 2.The leakage current sampling CT isn't installed properly	1. Check if there is any damage to the wiring between the Wall box and the Charging connector. 2. Restart the EV charger,unplug and plug the charging connector,than try again. 3. Disassemble the wall box and reinstall the leakage current sampling CT correctly If the problem occurs repeatedly, please contact Deye after-sales support team.
	F5	The voltage of CP circuit to ground is 0V, or the voltage is not equal to 6,9,12V	1.Check if the charging connector is in good condition and free of foreign objects. 2. Restart the EV charger,unplug and plug the charging connector,and then try again. If the problem occurs repeatedly, please contact Deye after-sales support team.
	F6	One or more built-in relays are faulty. Possible reasons: 1. The relay is stuck and cannot be disconnected. 2. The relay cannot be engaged.	Restart the EV charger,unplug and plug the charging connector,and then try again. If the problem occurs repeatedly, please contact Deye after-sales support team.
	F7	More than 1A charging current is detected when the built-in relays are not engaged. Possible reasons: Some components inside the wall box are faulty.	Restart the EV charger,unplug and plug the charging connector,and then try again. If the problem occurs repeatedly, please contact Deye after-sales support team.
	F8	The temperature detected by the sensor exceed 110°C. Possible reasons: 1.Overtemperature caused by high frequency of relay opening and closing. 2.The ventilation and heat dissipation at the installation site are poor	1.Make sure the input voltage of EV charger is stable. 2.Make sure good ventilation conditions at the installation point of the wall box and that the wall box is not covered by other objects. 3.Power off the EV charger, and cool down it for a period of time before restarting If the problem occurs repeatedly, please contact Deye after-sales support team.
	F9	1.The temperature detected by the sensor is lower than -40 °C. 2.The temperature sensor hasn't been assembled correctly.	1.Measure the ambient temperature to check wheether it is lower than -40°C or not. 2.Disassemble the wall box and reinstall the temperature sensor. 3.Contact Deye after-sales support team for help.
	F10	The PE wire is not connected or connected incorrectly	1.Check the PE wire connection of EV charger. In the following scenarios, EV chargers must be directly grounded: (1) Connect to single phase hybrid inverter. (2) Connect to the grid port of the three phase hybrid inverter. (3) No hybrid inverter, connect to other AC power sources for separate use. 2.When connecting an EV charger to the load port of a three-phase hybrid inverter and using it during off-grid operation of the hybrid inverter, it is necessary to enable the hybrid inverter's "signal island mode".
	F11	Lora communication fault. The chip for lora communication hasn't welded well	1.Disassemble the wall box and check if all the welding points of Lora communication chip are in good condition. 2.Contact Deye after-sales support team for help.

Note:For F6 & F11,after the fault is restored, restart the EV charger to restore normal operation.For other errors.For faults other than F6 and F11,the fault alarm time cycle is 20 seconds. If the fault is restored during this period, the EV charger will resume normal operation after the 20 second time cycle ends. Otherwise, after 20 seconds, the fault monitoring unit will retest and determine if the fault still exists. If no fault has occurred at the current time, the EV charger will immediately return to normal.

10. Technical Data

Model	SUN-EVSE11K01-EU-AC	SUN-EVSE22K01-EU-AC
Product Parameter		
Rated Voltage	400Va.c.(0.8Un to 1.15Un)	230Va.c.(0.8Un to 1.15Un), 400Va.c.(0.8Un to 1.15Un)
Connection Mode	3L+N+PE	L+N+PE,3L+N+PE
Rated Current	16Aa.c.	32Aa.c.
Rated Frequency	50/60Hz	
Maximum Output Power	11kW	7kW (single phase) 22kW (three phase)
Starting Method	Plug And Play/Charge After Scanning/Appointment For Charging	
Equipment Protection		
Over Temperature Protection	Yes	
Low Temperature Protection	Yes	
Over Voltage Protection	Yes	
Under Voltage Protection	Yes	
Short Circuit Protection	Yes	
Over Load Protection	Yes	
Earth Fault Protection	Yes	
Leakage Current Protection	DC 6mA	
Surge Protection Level	TYPE II	
General Data		
Operating Temperature Range	-40 ~ +55°C	
Permissible Ambient Humidity	5% ~ 95% No condensation	
Permissible Altitude	≤3000m	
Noise	< 25db	
Ingress Protection(IP) Rating	IP66	
Cabinet Size (W*H*D) [mm]	104x264x58	
Weight[kg]	3.7	
Gun Cable Length	4.2m	
Number Of Charging Guns	1	
Warranty	5 Years	
Safety EMC/Standard	EN IEC 61851-1:2019, IEC 61851-1:2017, EN 300 220-2 V3.1.1:2017, EN 300 328 V2.2.2:2019, EN IEC 62311:2020, EN 301 489-1 V2.2.3:2019, EN 301 489-3 V2.3.2:2023, EN 301 489-17 V3.3.1:2024, EN IEC 61000-6-1:2019, EN IEC 61000-6-3:2021, EN IEC 61851-21-2:2021	
General Data		
Communication Mode	LoRa/Wi-Fi/Bluetooth	

Lora communication distance	200m
Operating Frequency Band / Maximum output power	
Wi-Fi	2412-2472MHz (TX/RX) / 18.38dBm
Bluetooth Low Energy	2402-2480MHz (TX/RX) / 8.39dBm
Short Range Device	863-870MHz (TX/RX) / -1.49dBm
Lora Parameter	
Frequency range	863MHz-870MHz
Antenna	Internal Antenna
Antenna gain	0.56dBi

11. EU Declaration of Conformity

within the scope of the EU directives

- Radio Equipment Directive 2014/53/EU (RED)
- Restriction of the use of certain hazardous substances 2011/65/EU (RoHS)



NINGBO DEYE INVERTER TECHNOLOGY CO., LTD. confirms herewith that the products described in this document are in compliance with the fundamental requirements and other relevant provisions of the above mentioned directives. The entire EU Declaration of Conformity and certificate can be found at <https://www.deyeinverter.com/download/#smart-load>.

2025-08-13

EU Declaration of Conformity

Product: **EV charging station (AC charging pile)**

Models **SUN-EVSE22K01-EU-AC; SUN-EVSE11K01-EU-AC**

Name and address of the manufacturer: Ningbo Deye Inverter Technology Co., Ltd.
 No. 26 South Yongliang Road, Daqi, Beilun, Ningbo, China

This declaration of conformity is issued under the sole responsibility of the manufacturer. Also this product is under manufacturer's warranty.

This declaration of conformity is not valid any longer: if the product is modified, supplemented or changed in any other way, as well as in case the product is used or installed improperly.

The object of the declaration described above is in conformity with the relevant Union harmonization legislation:

- Radio Equipment Directive (RED) 2014/53/EU.
- Restriction of the use of certain Hazardous Substances (RoHS) Directive 2011/65/EU and 2015/863/EU



References to the relevant harmonized standards used or references to the other technical specifications in relation to which conformity is declared:

Health and Safety (RED, Article 3.1a)	
EN IEC 62311:2020	●
EMC (RED, Article 3.1b)	
EN IEC 61851-21-2:2021	●
EN IEC 61000-6-1:2019	●
EN IEC 61000-6-3:2021	●
EN IEC 61851-1:2019	●
EN 301489-1 V2.2:3:2019	●
EN 301489-3 V2.3.2:2023	●
EN 301489-17 V 3.3.1:2024	●
Radio Aspects (RED, Article 3.2)	
EN 300328 V2.2:2:2019	●
EN 300220-2 V 3.1.1:2017	●
RoHS	
EN IEC 63000:2018	●

Additional information: CE mark was affixed on the product since 2024.

Nom et Titre / Name and Title:

Bard Dai
Senior Standard and Certification Engineer
宁波德业逆变器有限公司
Ningbo Deye Inverter Technology Co., Ltd.
2025-07-03
Ningbo, China

Au nom de / On behalf of:

Date / Date (yyyy-mm-dd):

A / Place:

NINGBO DEYE INVERTER TECHNOLOGY CO., LTD

Add.: No.26 South YongJiang Road, Daqi, Beilun, NingBo, China.

Tel.: +86 (0) 574 8622 8957

Fax.: +86 (0) 574 8622 8852

E-mail: service@deye.com.cn

Web.: www.deyeinverter.com



30240301004828