

Chiron LRF

User's Manual



V1.0.0









Foreword

General

This manual introduces the functions and operations of Chiron LRF (hereinafter referred to as "the Camera"). Read carefully before using the device, and keep the manual safe for future reference.

Safety Instructions

The following signal words might appear in the manual.

Signal Words	Meaning
 DANGER	Indicates a high potential hazard which, if not avoided, will result in death or serious injury.
 WARNING	Indicates a medium or low potential hazard which, if not avoided, could result in slight or moderate injury.
 CAUTION	Indicates a potential risk which, if not avoided, could result in property damage, data loss, reductions in performance, or unpredictable results.
 ESD	Electrostatic Sensitive Devices. Indicates a device that is sensitive to electrostatic discharge.
 ELECTRIC SHOCK	Indicates dangerous high voltage. Take care to avoid coming into contact with electricity.
 LASER RADIATION	Indicates a laser radiation hazard. Take care to avoid exposure to a laser beam.
 TIPS	Provides methods to help you solve a problem or save time.
 NOTE	Provides additional information as a supplement to the text.

Revision History

Version	Revision Content	Release Time
V1.0.0	First release.	April 2024

Privacy Protection Notice

As the device user or data controller, you might collect the personal data of others such as their face, fingerprints, and license plate number. You need to be in compliance with your local privacy protection laws and regulations to protect the legitimate rights and interests of other people by implementing measures which include but are not limited to: Providing clear and visible identification to inform people of the existence of the surveillance area and provide required contact information.

About the Manual

- The manual is for reference only. Slight differences might be found between the manual and the product.
- We are not liable for losses incurred due to operating the product in ways that are not in

compliance with the manual.

- The manual will be updated according to the latest laws and regulations of related jurisdictions. For detailed information, see the paper user's manual, use our CD-ROM, scan the QR code or visit our official website. The manual is for reference only. Slight differences might be found between the electronic version and the paper version.
- All designs and software are subject to change without prior written notice. Product updates might result in some differences appearing between the actual product and the manual. Please contact customer service for the latest program and supplementary documentation.
- There might be errors in the print or deviations in the description of the functions, operations and technical data. If there is any doubt or dispute, we reserve the right of final explanation.
- Upgrade the reader software or try other mainstream reader software if the manual (in PDF format) cannot be opened.
- All trademarks, registered trademarks and company names in the manual are properties of their respective owners.
- Please visit our website, contact the supplier or customer service if any problems occur while using the device.
- If there is any uncertainty or controversy, we reserve the right of final explanation.

Important Safeguards and Warnings

This section introduces content covering the proper handling of the device, hazard prevention, and prevention of property damage. Read carefully before using the device, and comply with the guidelines when using it.

Transportation Requirements



- Transport the Camera within the allowed humidity and temperature conditions.
- Do not fall, squeeze, violently vibrate or immerse the device in liquid when transporting. Gently pick and place the Camera when moving, prevent the internal equipment becoming damaged or cable connection becoming loose.
- Do not transport the Camera without package. Use the factory default package or material of equal quality to pack the Camera when transporting it, otherwise the Camera can become easily damaged.

Storage Requirements



- Store the Camera within the allowed humidity and temperature conditions.
- Do not place the device in a humid, dusty or extremely hot or cold site that has strong electromagnetic radiation or unstable illumination.
- Do not squeeze, violently vibrate or immerse the device in liquid.
- Do not mechanically vibrate or crash when storing.
- Store the Camera in a ventilated place that has no strong electromagnetic radiation.
- For long-term storage of the battery, make sure that it is fully charged every half year to ensure the battery quality. Otherwise, damage may occur.

Operation Requirements



- Prevent liquid from flowing into the Camera to avoid damage to the internal components.
- Do not stuff foreign materials into the Camera to prevent a short circuit which could result in the Camera being damaged or people becoming injured.
- Do not expose the device to high electromagnetic radiation or dusty environments.
- Do not aim the lens at the sun or any other bright light.
- Improper use or replacement of the battery may result in explosion hazard.
- Do not charge other battery types with the supplied charger. Confirm there is no flammable material within 2 m of the charger during charging.
- Make sure that the plug is properly connected to the power socket.
- Do not connect multiple devices to one power adapter, to avoid over-heating or fire hazards caused by overload.
- If smoke, odor, or noise arises from the device, immediately turn off the power, unplug the power cable, and contact the service center.



- Do not dismantle the Camera. The internal components can only be repaired by a qualified professional. Dismantling it without professional assistance might cause water seeping in or might result in the Camera producing poor quality images.
- Operating temperature: $-30\text{ }^{\circ}\text{C}$ to $+55\text{ }^{\circ}\text{C}$ ($-22\text{ }^{\circ}\text{F}$ to $+121\text{ }^{\circ}\text{F}$), and the operating humidity shall be 95% or less.

Maintenance and Repair Requirements



DANGER

- Prevent liquid from flowing into the Camera to avoid damage to the internal components. In case the liquid enters the Camera, immediately stop using the Camera, cut off the power, and disconnect all the cables, and then contact your local customer service center.
- Use the accessories regulated by the manufacturer. The Camera should be maintained by qualified professionals.
- Make sure to cut off the power before cleaning the Camera, to prevent electric shock.



WARNING

If the Camera malfunctions, contact your local customer service center. Do not dismantle the Camera.



- Clean the Camera body with a piece of soft dry cloth. For any dirt that is hard to remove, pick up a piece of clean and soft cloth, dip it into a little neutral detergent and gently wipe the dust away. After that, wipe away all the remaining liquid on the Camera with another dry cloth. Never use volatile solvents such as alcohol, benzene and thinner, or cleaners that are strong and abrasive. Otherwise, the Camera's surface coating will be damaged and its working performance will be encumbered.
- Save the factory package of the Camera. When the Camera malfunctions, pack the Camera with the factory package and send to the dealer.



LASER RADIATION

Laser can cause damages to eyes. Do not look directly at the laser beam or observe the beam with optical devices when the laser is on.

Table of Contents

Foreword	I
Important Safeguards and Warnings.....	III
1 Product Introduction	1
2 Structure	2
2.1 Packing List.....	2
2.2 Device Description.....	2
3 Basic Operation	5
3.1 Starting and Shutdown	5
3.1.1 Manual Starting and Shutdown	5
3.1.2 Auto Shutdown.....	5
3.2 Image Adjustment.....	5
3.2.1 Adjusting Diopter.....	5
3.2.2 Adjusting Focus.....	6
3.2.3 Setting Color Palettes.....	6
3.2.4 Setting Digital Zoom.....	8
3.2.5 Setting Screen Brightness	9
3.2.6 Setting Image Brightness	9
3.2.7 Setting Contrast	9
3.2.8 Setting Sharpness.....	9
3.2.9 Setting Status Bar.....	9
3.3 Configuring the Camera.....	10
3.3.1 Menu Description	10
3.3.2 Brief Menu	10
3.3.3 Standard Menu	11
3.3.3.1 Setting Forest Mode	11
3.3.3.2 Setting Zeroing Profile.....	11
3.3.3.3 Setting Zeroing	11
3.3.3.4 Setting PIP	13
3.3.3.5 Setting Hot Point.....	13
3.3.3.6 Setting Wi-Fi Connection	13
3.3.3.7 Setting Laser Ranging	14
3.3.3.7.1 Measurement Considerations	14
3.3.3.7.2 Setting Laser Ranging Mode.....	15
3.3.3.8 Setting Smart Ballistics	15
3.3.3.9 Function Settings.....	18

3.3.3.10 Setting FFC Mode.....	18
3.3.3.11 Setting DPC	19
3.3.3.12 System Settings.....	19
3.4 Video and Snapshot	20
3.4.1 Recording Videos.....	20
3.4.1.1 Auto Recording	20
3.4.1.2 Recording Videos.....	20
3.4.2 Capturing Images	20
3.4.3 Exporting File.....	20
3.5 Power Supply.....	21
3.5.1 Installing the Battery	21
3.5.2 Charging.....	21
3.6 Installing Guide Rail	22
4 System Update.....	23
4.1 Upgrading Manually	23
4.2 Upgrading through App.....	23
Appendix 1 Compliance Notice.....	24

1 Product Introduction

The thermal monocular camera captures sharp thermal imaging at a fast frame rate for smooth, impeccable vision on running targets and from moving vehicles. Designed to increase situational awareness at any time of day, the Camera can detect humans, animals, and objects in complete darkness, haze, or through glaring light, equipping law enforcement professionals, hunters, and outdoor enthusiasts with reliable thermal imaging in tough conditions. Featuring the laser range finder, the Camera can accurately measure the target distance. It is widely used in outdoor scenarios for hunting, animal observation, and more.

2 Structure

2.1 Packing List

Figure 2-1 Packing list

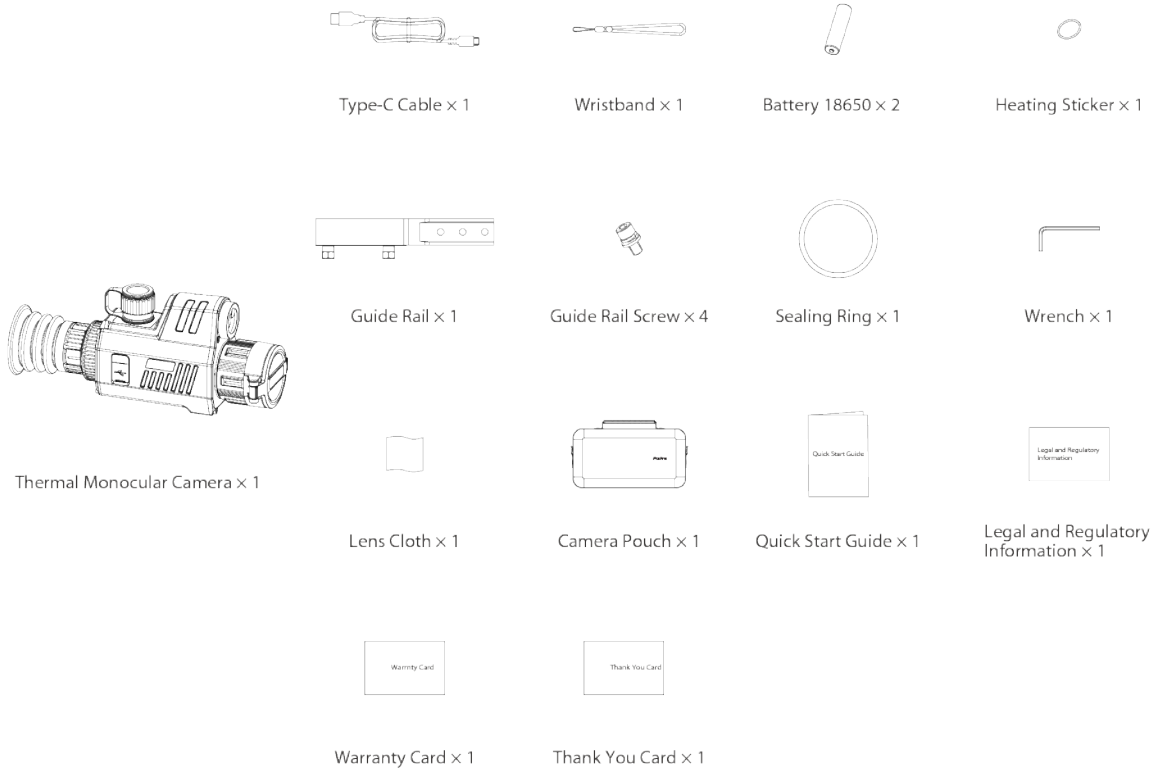

2.2 Device Description

Figure 2-2 Button description

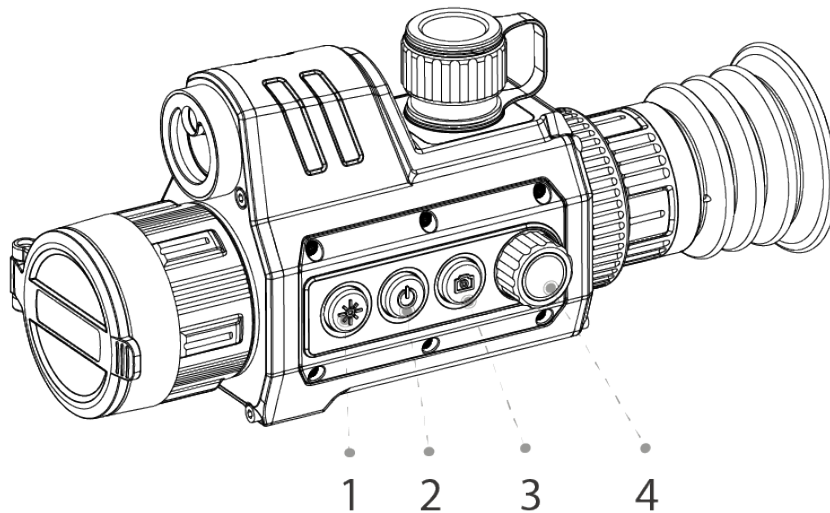

Table 2-1 Button description

No.	Name	Description
1	Laser button	<p>Press to enable the laser ranging mode.</p> <p>⚠ DANGER Laser can cause damages to eyes. Do not look directly at the laser beam or observe the beam with optical devices when the laser is on.</p> <p></p> <ul style="list-style-type: none"> • Make sure that you have set the laser ranging mode before enabling the function. For detail, see "3.3.3.7 Setting Laser Ranging". • The ranging function is only available when the distance is longer than 10 m.
2	Power button	<ul style="list-style-type: none"> • Press and hold to start or shut down the Camera. • Double-press to enter the sleep mode.
3	Capture button	<ul style="list-style-type: none"> • Press and hold to record videos. • Press to capture images.
4	Menu/Zoom/FFC button	<ul style="list-style-type: none"> • Press and hold to go to the standard menu. • Press to go to the brief menu. • Rotate the button for digital zoom. • Double-press to do the flat-field calibration for the image.

Figure 2-3 Component description

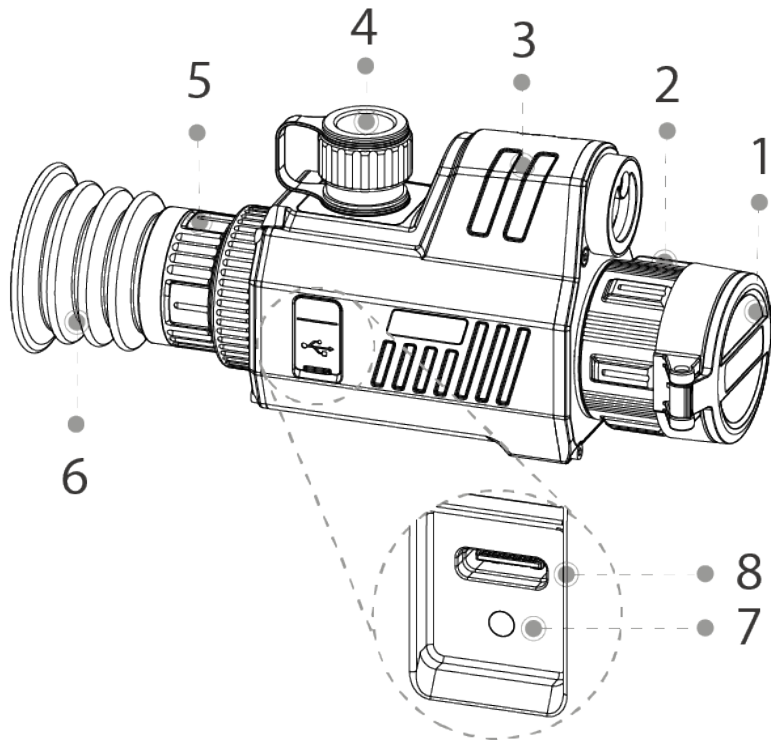





Table 2-2 Component description

No.	Name	Description
1	Protective cover	Dust prevention. Close the cover when not using the Camera.
2	Adjustable lens	Manually rotate the focusing ring to adjust the focus for a clear image.
3	Laser module	<p>Measures the distance between the Camera and the target.</p> <p> DANGER Laser can cause damages to eyes. Do not look directly at the laser beam or observe the beam with optical devices when the laser is on.</p>
4	Battery compartment	The place for holding the battery.
5	Diopter adjustment rotary knob	Adjust according to your eyesight.
6	Eyeshade	Protects the eyes from glare.
7	Charging indicator	<ul style="list-style-type: none"> ● Red and green lights flashing alternately: charging error. ● Red light on: charging. ● Green light on: fully charged. ● Off: not connected to data cable to charge.
8	Type-C port	<ul style="list-style-type: none"> ● Connects to a data cable for charging. ● Connects the Camera to a smart phone to view live images through the app. ● Connects to the Camera to a computer for exporting files.

3 Basic Operation





3.1 Starting and Shutdown

3.1.1 Manual Starting and Shutdown

Press and hold  to start or shut down the Camera; double-press  to suspend the Camera.



After starting the Camera, remove the protective cover of the lens.

- When the Camera is off, press and hold  to start it.
- When the Camera is on, press and hold  to shut down it.
- When the Camera is on, double-press  to suspend the Camera.
- When the Camera is in suspend mode, press  to weak up it.

3.1.2 Auto Shutdown

Step 1 Press and hold  to go to the standard menu.

Step 2 Rotate  to select .

Step 3 Press  to go to the **System Setting** configuration screen.

Step 4 Rotate  to select .

Step 5 Press  to set the auto shutdown time.

If there is no operation in the configured time, the Camera will automatically shut down.

3.2 Image Adjustment

3.2.1 Adjusting Diopter

To get clear images, rotate the diopter knob to fit your eyesight.



For the first-time use, adjust the diopter before configuring the functions.

Step 1 Aim the lens at the target, and then make your eyes close to the eyeshade.

Step 2 Adjust clockwise or counterclockwise the eyepiece to your eyesight.

Figure 3-1 Adjust diopter

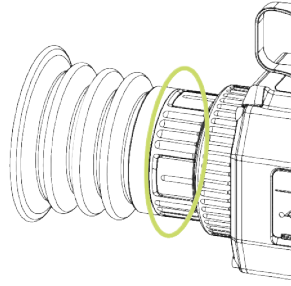

3.2.2 Adjusting Focus

Manually rotate the focusing ring to adjust the focus for a clear image.

Step 1 Aim the thermal lens to the target.

Step 2 Adjust clockwise or counterclockwise the focusing ring until the view is clear.



During the adjustment, do not touch the lens to avoid smudging it; otherwise it may affect the image quality.

Figure 3-2 Adjust focusing

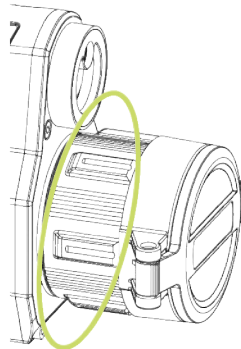

3.2.3 Setting Color Palettes

Select the color palettes, which adds color to the thermal image and uses color to indicate the temperature.

Step 1 Press  to go to the brief menu.

Step 2 Press  to select .

Step 3 Rotate  to select the color palettes.

- White Hot (WH): The objects with high temperature are white. The higher the temperature, the brighter the color.
- Sepia (SP): The objects with high temperature are amber. The higher the temperature, the brighter the color.
- Green Hot (GH): The objects with high temperature are green. The higher the temperature, the brighter the color.
- Alarm (AM): The objects with high temperature are red. The objects can stand out.
- Iron Red (IR): The objects with high temperature are red. The higher the temperature,

the brighter the color.

- Black Hot (BH): The objects with high temperature are black. The higher the temperature, the darker the color.

Figure 3-3 White hot



Figure 3-4 Sepia



Figure 3-5 Green hot



Figure 3-6 Alarm



Figure 3-7 Iron red



Figure 3-8 Black hot



3.2.4 Setting Digital Zoom

Digital zoom helps to zoom in the image.

On the viewing screen, rotate  to do digital zoom, and the image changes.

3.2.5 Setting Screen Brightness

Adjusts the overall screen brightness. The higher the level is, the brighter the screen will be.

Step 1 Press  to go to the brief menu.



You can also press and hold  to go to the standard menu.

Step 2 Press  to select .

Step 3 Rotate  to set the brightness level. The higher the level is, the brighter the screen will be.

3.2.6 Setting Image Brightness

Adjusts the image brightness. The higher the level is, the brighter the screen will be.

Step 1 Press and hold  to go to the standard menu.

Step 2 Rotate  to select .

Step 3 Press  to set the brightness level. The higher the level is, the brighter the image will be.

3.2.7 Setting Contrast

Adjusts the contrast of the picture. The higher the level is, the more the contrast will be between bright and dark areas.

Step 1 Press  to go to the brief menu.



You can also press and hold  to go to the standard menu.

Step 2 Press  to select .

Step 3 Rotate  to set the contrast level. The higher the level is, the more the contrast will be between bright and dark areas.

3.2.8 Setting Sharpness

Step 1 Press  to go to the brief menu.



You can also press and hold  to go to the standard menu.

Step 2 Press  to select .

Step 3 Rotate  to set the sharpness level. The higher the level is, the clearer the picture edges will be.







3.2.9 Setting Status Bar

Step 1 Press hold  to go to the standard menu.

Step 2 Rotate  to select  > **OSD**.

Step 3 Press  to enable OSD, and the status bar is displayed.





Table 3-1 Description of status bar

Icon	Name	Description
	Wi-Fi	<ul style="list-style-type: none"> : The Wi-Fi function is disabled. : The Wi-Fi function is enabled.
	Digital zoom	Supports 1×, 2×, 4× and 8× digital zoom. The number might different depending on models.
	Battery level (built-in)	Displays the battery (built-in) level in real time.
	Battery level (dry cell)	Displays the battery (dry cell) level in real time.

3.3 Configuring the Camera

3.3.1 Menu Description

When the Camera is on, press and hold  to go to the standard menu. Functions of all buttons are as follows.

- Rotate  to move upward or downward the cursor.
- Press  to set the parameters and confirm.
- Press and hold  or press  to exit.

3.3.2 Brief Menu

Press  to go to the brief menu. You can set color palettes, brightness, contrast, and select the zeroing profile.

Step 1 Press  to go to the brief menu.

Figure 3-9 Brief menu







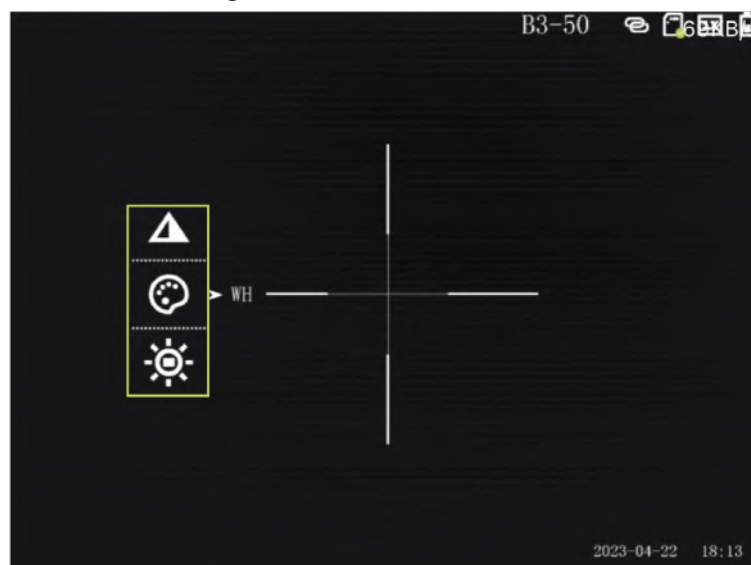





Step 2 Press  to select the parameters to be configured.

Table 3-2 Brief menu

Parameters	Description
Color palettes 	Rotate  to select the color palettes, which adds color to the thermal image and uses color to indicate the temperature.
Contrast 	Rotate  to select the contrast level.
Brightness 	Rotate  to select the brightness level.
Sharpness 	Rotate  to select the brightness level.

Step 3 Press and hold  to exit and save the configuration.

3.3.3 Standard Menu

3.3.3.1 Setting Forest Mode

Step 1 Press and hold  to go to the standard menu.

Step 2 Rotate  to select .

Step 3 Press  to enable or disable the forest mode.

- ON: Forest mode. Stands out the targets with high temperature, which makes it easier to find out the targets.
- OFF: Standard mode. Used for daily observation.

3.3.3.2 Setting Zeroing Profile

Prerequisites

Before setting zeroing profile, make sure that you have configured zeroing in **Zeroing**. For details, see "3.3.3.3 Setting Zeroing".

Procedure

Step 1 Press and hold  to go to the standard menu.

Step 2 Rotate  to select .

Step 3 Press  to select the zeroing profile as needed.



The Camera supports multiple zeroing profiles.

3.3.3.3 Setting Zeroing

Prerequisites

Before setting zeroing, make sure that you have selected the zeroing group in **Zeroing Profile**. For details, see "3.3.3.2 Setting Zeroing Profile".

Procedure

Step 1 Press and hold  to go to the standard menu.

Step 2 Rotate to select .

Step 3 Press to go to the zeroing configuration screen.

Step 4 Rotate to select the parameters to be configured.

- Reticle No. (): Press to select a number as the reticle number.
- Type (): Press to select the reticle type.



The Camera supports multiple reticles.

- Color (): Press select the reticle color from **White, Red, Green**.
- Distance (): Press to select the distance between the target and the Camera.

Step 5 Adjust the reticle.

When the cursor is offset, select , and then press to go to the reticle adjustment screen.

- 1) Set the distance. Press , and the **Distance Setting** screen is displayed.
 - Rotate to set the value.
 - Press to switch the digits.
 - Press and hold to exit and save the configuration.
- 2) After shooting at the target, select and then press to freeze the image.
- 3) Select , and then press to select X-axis and Y-axis.
- 4) Rotate to move the reticle to the shooting point, and then press .
- 5) Rotate to select and then press to save the configuration.

Figure 3-10 Adjust the reticle



3.3.3.4 Setting PIP

After enabling PIP, the target with the reticle can be magnified in the OSD image, which offers a closer view of the target with the whole visual scene.

Step 1 Press and hold  to go to the standard menu.

Step 2 Rotate  to select .

Step 3 Press  to enable or disable PIP.

- On: An OSD image is displayed on the screen, and the target with the reticle can be magnified in the OSD image.
- Off: Disable the PIP.

3.3.3.5 Setting Hot Point

Tracks the point with the highest temperature in real time.

Step 1 Press and hold  to go to the standard menu.

Step 2 Rotate  to select .

Step 3 Press  to enable or disable the hot point.

After enabling the hot point, the hot point icon will automatically locate at the points with the highest temperature in the image.

3.3.3.6 Setting Wi-Fi Connection

After enabling Wi-Fi connection, you can connect your phone to the hotspot of the Camera, and then access the Camera with the app.

The frequency bands and modes and the nominal limits of transmitted power (radiated and/or conducted) applicable to this radio device are the following:

Wi-Fi 2.4 GHz (2.4 GHz to 2.4835 GHz)	20 dBm
---------------------------------------	--------



Some cameras will automatically disable the Wi-Fi function when the battery level is lower than 15%.

Step 1 Scan the QR code with your smart phone to install the app.

Figure 3-11 QR code



Step 2 Press and hold  to go to the standard menu.

Step 3 Rotate  to select .















Step 4 Press  to enable the Wi-Fi function.

- Wi-Fi name: Model number + serial number.
- Wi-Fi password: 12345678.

Step 5 Log in to the app.

Add access devices according to the prompt.

Related Operations

- Change the password
 1. On the main menu, rotate  to select .
 2. Press  to go to the **System Settings** configuration screen.
 3. Select  > .
 4. Press  to go to the password set screen.
 5. Press  to select the digital to be set, and then rotate  to set the value.
- Reset the password
 1. On the main menu, rotate  to select .
 2. Press  to go to the **System Settings** configuration screen.
 3. Select  > .
 4. Press  to reset the password.

3.3.3.7 Setting Laser Ranging



Laser can cause damages to eyes. Do not look directly at the laser beam or observe the beam with optical devices when the laser is on.

3.3.3.7.1 Measurement Considerations

Measurement targets

The Camera is suitable for measuring the distance between the camera and the targets with high reflectivity (such as road signs on highways), the targets with moderate reflectivity (such as wall) and the targets with low reflectivity (such as tree, golf flag, utility pole, and animal). When the reflectance is reduced to a certain extent, the range will be reduced accordingly.

Factors that influence ranging capability

- Target reflectivity: Generally, the higher the reflectivity of the target, the better the ranging ability. For example, the measuring range of the Camera is 1,500 m for a target with moderate reflectivity, which can be up to 1,800 m for a target with high reflectivity, and 600 m for the targets with low reflectivity. (It might fail to measure the target that hardly generates diffuse reflection, such as water surface.)
- Target shape: When a target is too small or uneven, the ranging ability will decrease.
- Measuring angle: The measurement is more accurate when the reflection surface of target is vertical to the laser emission's direction. If you use the Camera under some extreme conditions, the measurement might be inaccurate.
- Measuring environment: The environment factors include sunshine intensity, the concentration of water vapor in the air and suspended particles (such as rain, fog, snow, fog and haze).

The range ability of the Camera defined under the following conditions:

- The measurement target is with moderate reflectivity, such as walls.
- The reflection surface of target is vertical to laser emission direction.
- The weather condition is sunny but not under the condition of direct sunlight.
- The reflection area is larger than 2 m × 2 m.

3.3.3.7.2 Setting Laser Ranging Mode

After setting the laser ranging mode, the Camera can measure the range towards targets.



To guarantee the measurement accuracy, keep your hand steady when measuring the range.

Step 1 Press and hold  to go to the standard menu.

Step 2 Rotate  to select .

Step 3 Press  to select the laser ranging mode.

- **Once:** After pressing the laser button, the Camera measures the distance between the camera and the target once.
- **Continue:** After pressing the laser button, the Camera continuously measures the distance between the Camera and the target in 15 s.

3.3.3.8 Setting Smart Ballistics

Prerequisites





Before setting smart ballistics, make sure that you have configured zeroing in **Zeroing**. For details, see "3.3.3.3 Setting Zeroing".

Procedure

Step 1 Press and hold  to go to the standard menu.

Step 2 Rotate  to select .

Step 3 Press  to set smart ballistics.

- Press  to enable or disable smart ballistics.
 - ◇ **ON:** Enable the smart ballistics function. The Camera can calculate the landing point of the bullet automatically according to configured parameters.
 - Select **Once** as the laser ranging mode, and then press the laser button, the landing point of the bullet is displayed on the reticle based on the single ranging result.
 - Select **Continue** as the laser ranging mode, and then press the laser button, the Camera continuously measures the distance. Press the laser button again to confirm the measuring result, and landing point of the bullet is displayed on the reticle.
 - ◇ **OFF:** Disable the smart ballistics function. The Camera will not calculate the landing point of the bullet.
- Press  to set the parameters.
 1. Rotate  to select the parameter to be configured.
 2. Press  to go to the configuration screen.

3. Rotate  to set the value.

Table 3-3 Parameters of ballistic calculations

Parameters	Description
Ballistic Profile	Displays the zeroing profile that you selected in .."3.3.3.2 Setting Zeroing Profile".
Zero Range	Displays the distance that you configured in "3.3.3.3 Setting Zeroing".
Init Velocity	Enter the value according to the actual situation.
Altitude	The altitude of the current location.
Temperature	The current ambient temperature.
Ballistic Coefficient	Enter the value according to the actual situation.
Sight Height	The distance from the muzzle axis to the camera axis. The distance from the muzzle axis to the camera axis

4. Press and hold  to save the configuration.

Figure 3-12 Calculation result (target distance \leq configured distance)



Figure 3-13 Calculation result (target distance = configured distance)



Figure 3-14 Calculation result (target distance \geq configured distance)



3.3.3.9 Function Settings

















Step 1 Press and hold  to go to the standard menu.

Step 2 Rotate  to select .

Step 3 Press  to go to the **Function** screen..

Step 4 Rotate  to select function to be configured.

Table 3-4 Function settings

Function	Description
Compass 	Press  enable the Compass function, and the location information is displayed on the screen.
Compass Init 	Press  to initialize the location. In 15 s, rotate the scope along the three axes indicated by the icon, with each axis rotating at least 360°. After 15 s, the calibration completes automatically and exit to the main menu.
Burning Warning 	Press  to enable the burning warning function. When the lens is in the risk of burning, a note will be displayed on the screen and the shutter will be off automatically.
Logo 	Press  to enable logo display, and the logo will be display on the left lower corner of the screen.
OSD 	Press  to enable OSD display, and the status bar is displayed.
FFC Mode 	Press  to select the FFC (Flat-Field Calibration) mode from Auto and Manual . For details, see "3.3.3.10 Setting FFC Mode".
DPC 	Press  to enable DPC (Defective Pixels Correction), and then you can correct the defective pixels in the image. For details, see "3.3.3.11 Setting DPC".
Auto REC 	When the impact sensor of the Camera detects impact, it will automatically record the video, recording the wonderful moment of hunting. For details, see "3.4.1.1 Auto Recording".
MIC 	Press  to enable or disable the microphone. <ul style="list-style-type: none"> • On: The videos are recorded with sound. • Off: The videos are recorded without sound.

3.3.3.10 Setting FFC Mode

With FFC (Flat-Field Calibration), the thermal image can be optimized, and you can easily find out temperature changes.

Step 1 Press and hold  to go to the standard menu.

Step 2 Rotate  to select  > .

Step 3 Press  to select the FFC mode.

- Auto: The camera calibrates image automatically every certain period.
- Manual: On the viewing screen, double-press  to manually calibrate the image.

3.3.3.11 Setting DPC



After enabling DPC (Defective Pixels Correction), you can correct the defective pixels in the image.

Step 1 Press and hold  to go to the standard menu.

Step 2 Rotate  to select  > .

Step 3 Press  to go to the FFC mode configuration screen.

Step 4 Rotate  to select the FFC mode.

- Auto: The Camera automatically corrects the defective pixels in the image.
- Manual: The Camera automatically corrects the defective pixels in the image.
 1. Press  to select X-axis and Y-axis.
 2. Rotate  to make the cursor coincide with the defective pixel.
 3. Press and hold  to save the configuration.



The center of the cursor is the position of the defective pixel.

- Restore: The DPC configuration is restored to the primary state.

3.3.3.12 System Settings

Step 1 Press and hold  to go to the standard menu.

Step 2 Rotate  to select .

Step 3 Press  to go to the **System Setting** screen..













Step 4 Rotate  to select the parameter to be configured.

Table 3-5 System settings

Parameter	Description
Auto Standby	Press  to set the auto standby time. The Camera will automatically standby in the configured time.
Auto Shutdown	Press  to set the auto shutdown time. For details, see "3.1.2 Auto Shutdown".
USB Mode	Press  to select the USB mode. <ul style="list-style-type: none"> • ON: The Camera can be used as a storage device. • OFF: Charge the Camera.
Language	Press  to select the language as needed.
Unit	Press  to select the unite from m and yd .
Version	Press  to view the device information
Restore Default	Press  to restore the parameters to the defaults.
Time Set	Press  to select the time to be configured; Press  to select year, month, day, hour or minute, an then rotate  to set the value.

Parameter	Description
Time Display	Press  to display the time. <ul style="list-style-type: none"> • Time: The time is displayed on the lower right corner of the screen. • Date&Time: The date and time is displayed on the lower right corner of the screen. • OFF: The date and time is not displayed on the screen.

3.4 Video and Snapshot

3.4.1 Recording Videos

3.4.1.1 Auto Recording

When the impact sensor of the Camera detects impact, it will automatically record the video, recording the wonderful moment of hunting.



Step 1 Press and hold  to go to the standard menu.

Step 2 Rotate  to select  > .

Step 3 Press  to enable or disable **Auto REC**.

- On: The Camera will record videos when the impact sensor of the Camera detects impact.
- Off: The Camera will not record videos any time.

3.4.1.2 Recording Videos

On the viewing screen, press and hold  for 3 seconds to start recording a video. The green icon  and the recording time is display.

Press and hold  again for 3 seconds to stop the recording. When the recording stops, the recording time will display normally.

3.4.2 Capturing Images

On the viewing screen, press  to capture images.

The screen will display an icon when the capturing succeeds.

3.4.3 Exporting File

Exports the recorded and captured files.

Step 1 Connect the Camera to the computer through Type-C data cable.

The driver will automatically be installed for first-time connection.



- Connect the cables before starting the Camera. Do not hot swap the Type-C port of the Camera.
- Enable USB mode on the **USB Mode** configuration screen after connecting the Camera to the computer.

Step 2 On the computer desktop, double-click **My Computer**, and then open the Camera disk at a mobile storage device.

Step 3 Select the files to export and copy them to the computer.
The specific computer client is required for playing the exported files.

Step 4 Disconnect the Type-C data cable with the computer.
After connecting the Camera to the computer, images can be displayed on the Camera, but the functions of recording and capturing will not be available.

3.5 Power Supply

You can supply power to the Camera through the rechargeable battery coming with the Camera or charging with the Type-C cable.

3.5.1 Installing the Battery

Step 1 Open the cover of the battery compartment.

Step 2 Put one battery into the battery compartment.



Make sure that the battery is installed with the positive electrode downward.

Step 3 Tighten the cover.

3.5.2 Charging

The start bar will display battery information after the Camera starts. When the battery is low, charge the Camera timely to make sure the normal function.

- During charging, keep the battery temperature 0 °C to +60 °C (+32 °F to +140 °F).
- Charge the Camera with the data cable that comes with the delivery.

Step 1 Open the sealing cover of the port when charging.

Step 2 Connect the Type-C cable to the port to charge the Camera.

The charging indicator states:

- Red and green lights flashing alternately: charging error.
- Red light on: charging.
- Green light on: fully charged.
- Off: not connected to data cable to charge.

3.6 Installing Guide Rail

Prerequisites

Before installing the guide rail, shut down the Camera and clean the bracket and guide rail with clean cloth.

Procedure

- Step 1 Fix the Camera on the guide rail with the fixed screws.
- Step 2 Tighten the knobs of the guide rail.







Figure 3-15 Install guide rail



4 System Update

Update the Camera manually or through the app.

4.1 Upgrading Manually

- Step 1 Press and hold  to go to the standard menu.
- Step 2 Rotate  to select .
- Step 3 Press  to go to the **System Setting** configuration screen.
- Step 4 Rotate  to select .
- Step 5 Press  to enable USB mode.
- Step 6 Copy the upgrading file (.bin).
- Step 7 Restart the Camera.

4.2 Upgrading through App

When the app detects new program for upgrading, it will prompt a notification. Tap **Upgrade** to upgrade the system.

Appendix 1 Compliance Notice

The thermal series products might be subject to export controls in various countries or regions, including without limitation, the United States, European Union, United Kingdom and/or other member countries of the Wassenaar Arrangement. Please consult your professional legal or compliance expert or local government authorities for any necessary export license requirements if you intend to transfer, export, re-export the thermal series products between different countries.