

**ThermTec**



# User Manual

Thermal Imaging Monocular

# CYCLOPS SERIES



IOS



Android

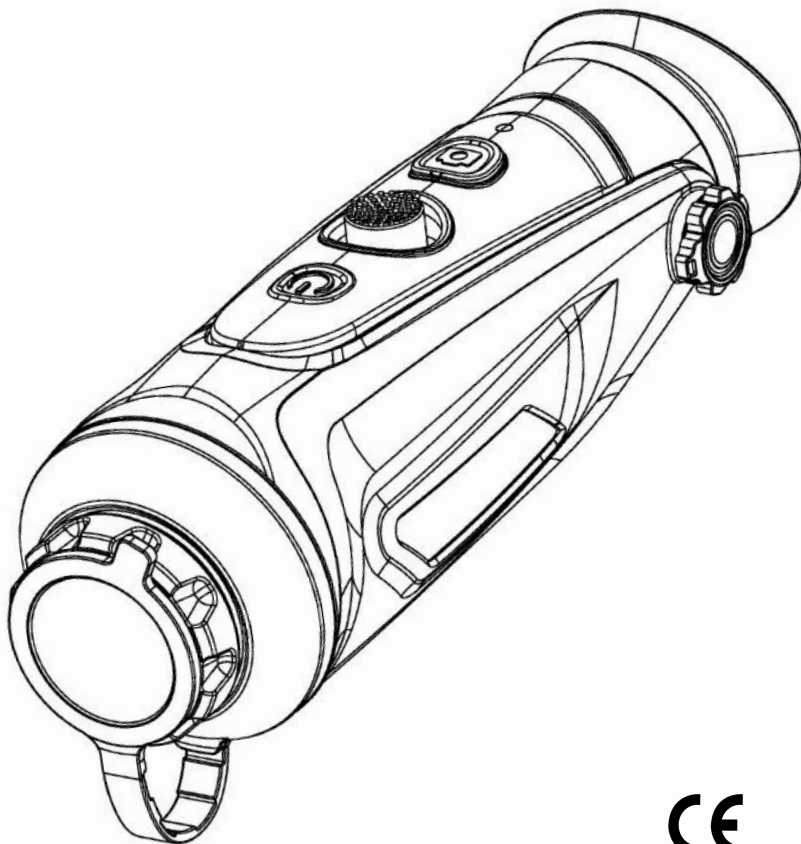

CE

RoHS



EAC

# Table of Contents

About This Manual	4	3.3.3.2 Pseudo Color Switch	12
Regulatory Information	5	3.3.3.3 AI Ranging	13
1. Introduction	6	3.3.4 Capture/Record	13
1.1 Device Description	6	3.4 Settings	13
1.2 Features	7	3.4.1 Image Setting	13
1.3 Detection Range	8	3.4.2 System Setting	14
1.4 Application Scenarios	8	3.4.3 Network Connection	15
1.5 Cautions	8	3.4.3.1 App Download	15
2. Packing List	9	3.4.3.2 Connect via Wi-Fi	16
3. Operation Guide	9	3.4.3.3 Connect via Hotspot	16
3.1 Battery Charging	9	3.4.4 APP Push Notification	17
3.2 Power on/off	10	3.4.5 File Management	18
3.3 Buttons and Controls	10	3.5 External Video & Data Reading	19
3.3.1 Buttons Features and Introduction	10	3.6 System Software Upgrade	19
3.3.2. Lens Adjustment	11	4. Technical Data	20
3.3.3 Rocker Button Operation	11	4.1 Product Size & Drawing	20
3.3.3.1 Zoom	11	4.2 Specifications	21

# About This Manual

COPYRIGHT © 2022 ThermTec Technology Co., Ltd. ALL RIGHTS RESERVED.

Any and all information, including, among others, wordings, pictures, graphs are the properties of ThermTec Technology Co., Ltd. or its subsidiaries (hereinafter referred to be “ThermTec” ). This user manual (hereinafter referred to be “the Manual” ) cannot be reproduced, changed, translated, or distributed, partially or wholly, by any means, without the prior written permission of ThermTec. Unless otherwise stipulated, ThermTec does not make any warranties, guarantees or representations, express or implied, regarding to the Manual.

This Manual is applicable to Thermal Imaging Monocular.

The Manual includes instructions for using and managing the product. Pictures, charts, images and all other information hereinafter are for description and explanation only. The information contained in the Manual is subject to change, without notice, due to firmware updates or other reasons.

# Regulatory Information



This product and, if applicable, the supplied accessories are marked with “CE” and comply therefore with the applicable harmonized European standards listed under the Radio Equipment Directive 2014/53/EU, the EMC Directive 2014/30/EU, the RoHS Directive 2011/65/EU.



2012/19/EU (WEEE directive): Products marked with this symbol cannot be disposed of as unsorted municipal waste in the European Union. For proper recycling, return this product to your local supplier upon the purchase of equivalent new equipment, or dispose of it at designated collection points. For more information see: [www.recyclethis.info](http://www.recyclethis.info).

# 1

## Introduction

### 1.1 Device Description

ThermTec Cyclops Series Thermal Imaging Monocular, the new generation intelligent thermal imaging monocular, is designed with a 12 $\mu$ m uncooled infrared detector and can be equipped with 15mm/25mm/35mm lens and 1024x768 OLED high-definition display. With AI image recognition algorithm, it enables users to get clear views under various lighting conditions, even in complete darkness, providing reliable and high-quality visual images for night activities. In particular, the function of easy connection to mobile phones enables users to share views in real time.

# 1.2 Features

## 1. Mechanical Rocker Design

It balances the central of gravity, providing an easier and outstanding handheld experience.

## 2. 12 $\mu$ m VOx Detector

The 12 $\mu$ m VOx detector provides images with better quality, and ensures perfect detail recognition.

## 3. OLED Display

Designed with 1024x768 OLED display, it brings outstanding HD image quality as well as great durability, making it operable in a broader temperature range as low as minus 20°C.

## 4. AI Intelligent Ranging

Based on the deep learning algorithm, the monocular can automatically measure the object distance.

## 5. Two-way Wi-Fi Design

It supports both WIFI and hotspot connection, which allows users to share images and videos with friends in real time.

## 6. Photo and Video Playback

Integrated pictures and video recording makes sharing the thermal action quick and easy, with the functions of playback and APP sharing.

## 7. Long Battery Life

Built-in battery with up to 12H super long standby, recording every and instant moment of your hunting and outdoor experience.

## 8. GPS Function

Enable user to know his own coordinates in real time, which makes field activities safer.

## 9. Smooth Zooming

Continuous 1.0-6.0 HD zooming ensures excellent sharpness and the highest resolution of details from minimum to maximum magnification.

## 10. IP67 Protection Design

Provided with IP67-rated weatherproof performance, it is capable of capturing images/videos through rain, snow, smoke, smog, or dust.

### 1.3 Detection Range

The illustration below shows the comparative range performance of the monocular with different lens configurations. The data is based on detecting a car of 4m, a man of 1.8m tall, a wild boar of 0.7m tall, a wolf of 0.5m tall, a rabbit of 0.3m tall and a bird of 0.2m tall.

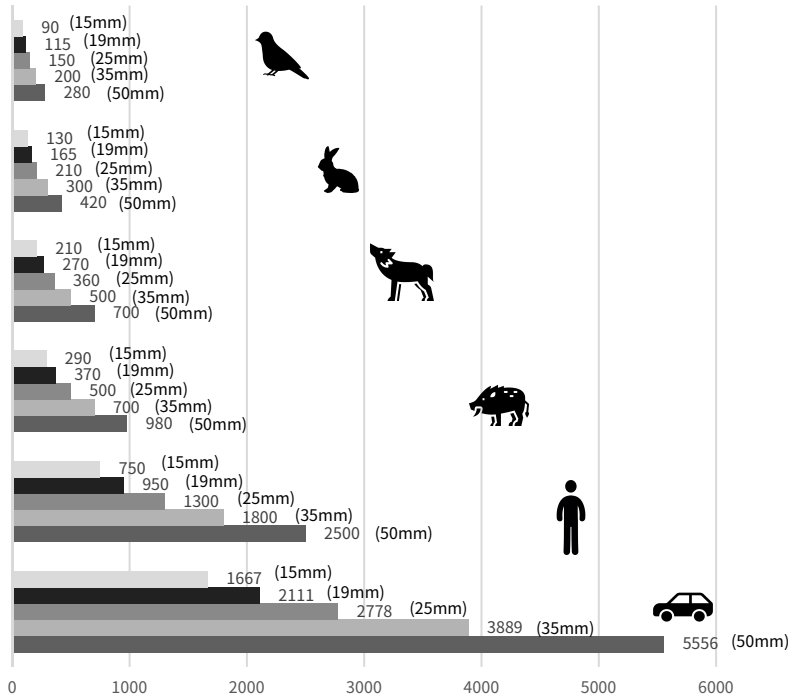

### 1.4 Application Scenarios

- Animal Observation
- Outdoor Adventure
- Security Law Enforcement
- Emergency Search and Rescue

### 1.5 Cautions



## CAUTION



Avoid hard objects.



Do not aim the lens directly at the sun or high-temperature light sources.



Do not use the device in extremely cold or hot environment.



Charge the battery once every three months when it is not used for a long period of time.



Make sure the USB cover is tightly closed when used in water environment.



Do not irradiate the laser indicator of the device to human eyes.



Do not disassemble or modify the device by yourself in any way.



# 2

## Packing List

Monocular	1
Lanyard	1
USB cable	1
Video output cable	1
Carry bag	1
User manual	1



Monocular  
(x1)



Lanyard  
(x1)



USB cable  
(x1)



Video output cable  
(x1)



Carry bag  
(x1)



User manual  
(x1)

# 3

## Operation Guide

### 3.1 Battery Charging

The battery should be fully charged prior to use.

Note: The battery is not user replaceable.

Follow the below steps to charge the battery:

1. Lift the cover from the USB port.
2. Plug the cable provided into the USB port.
3. Plug the opposite end of the cable into a USB power source.

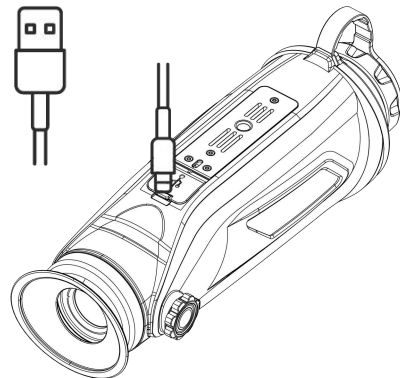

Notes: When the charging indicator on the device becomes red, it means you need to charge the device immediately. The indicator turns to red when it is charging and turns to green when it finishes charging. After it turns to green, stop charging.

### 3.2 Power on/off

	<b>Power on</b>	<b>Power off</b>
	Hold the POWER button for four seconds and the boost screen will be shown.	When the device is turned on, hold the POWER button for four seconds to power off the device.



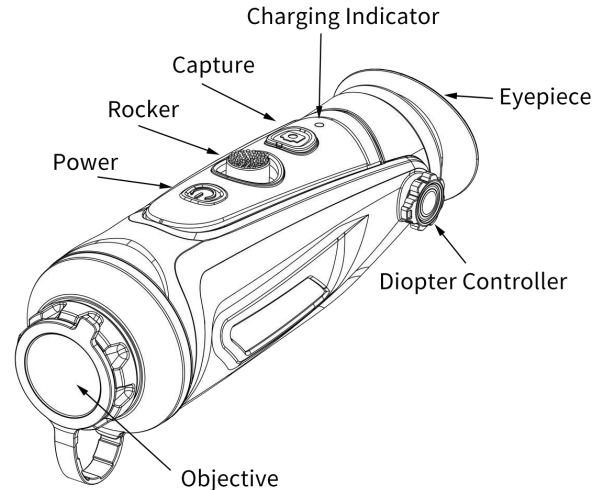

Note: Refer to Figure 1 for the main view of the monocular.

### 3.3 Buttons and Controls

#### 3.3.1 Button Features and Introduction



**Figure 1**

	<b>Press and Hold</b>	<b>Press</b>	<b>Double-Click</b>
	Power on/off	Standby mode on/off	Laser indicator on/off
	Take videos	Take photos	
	⊕ Zoom in ⊖ Zoom out	 Peseudo color switch  AI ranging	Main menu

### 3.3.2 Lens Adjustment

#### Diopter Adjustment

Looking through the eyepiece, adjust the position of diopter level to optimize the image sharpness on the OLED display.

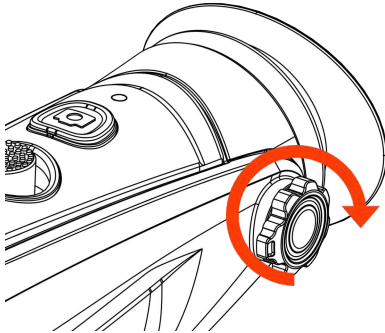

#### Objective Lens Focusing

Manually adjust the objective lens focus when necessary.

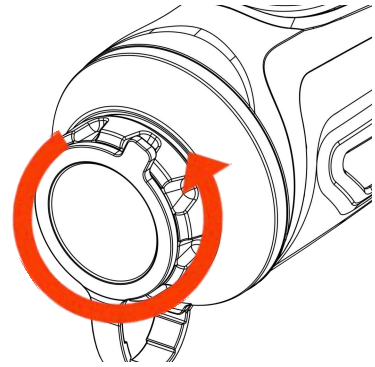

### 3.3.3 Rocker Button Operation

#### 3.3.3.1 Zoom

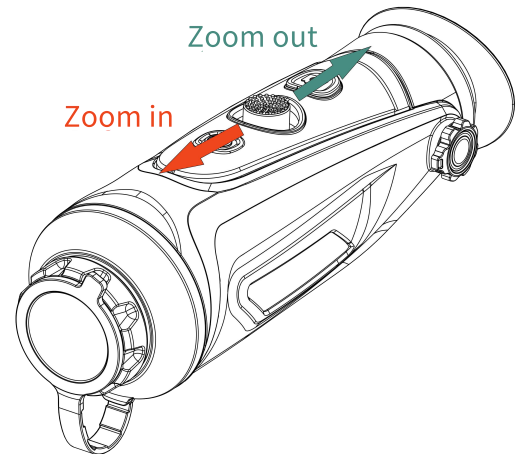

### 3.3.3.2 Pseudo Color Switch

Use rocker button towards right to switch pseudo color.

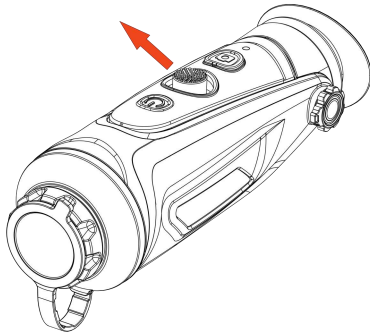

There are six color palettes by default. You can choose the pseudo color you want by customizing. Unwanted colors can be turned off in the system setting.



### Color Palettes



White



Black



Red



Green



Golden



Violet

### 3.3.3.3 AI Ranging

Use the rocker button towards left to enable or disable AI ranging function (before this function is enabled, please make sure the device is in AI ranging mode. Otherwise, refer to Section 3.4 for setting).

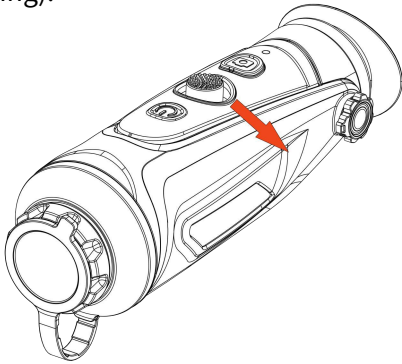

AI Ranging Function

### 3.3.4 Capture/Record

Press  to take photos. Then the photo icon in the upper left corner will flash once.

Press and hold  to take videos. Then the recording icon in the upper left corner starts flashing, and the recording starts timing. Press and hold again to stop recording.

### 3.4 Settings

Double-click the rocker button to enter Setting menu.

Note: Select by moving the rocker button, and short-press the rocker button to confirm the selection.

#### 3.4.1 Image Setting

Press  to enter the Imaging Setting menu. There are five sub-menus for image setting, which are “Image Mode”, “Sharpness”, “Denoise”, “Brightness” and “Contrast” .

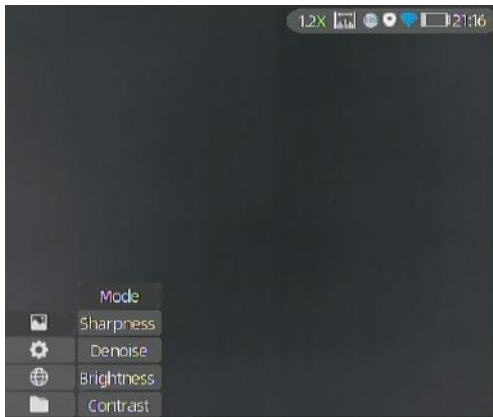

### 3.4.2 System Setting

Press  to enter the System Setting menu. Select by moving the rocker button, and short-press the rocker button to confirm the selection.

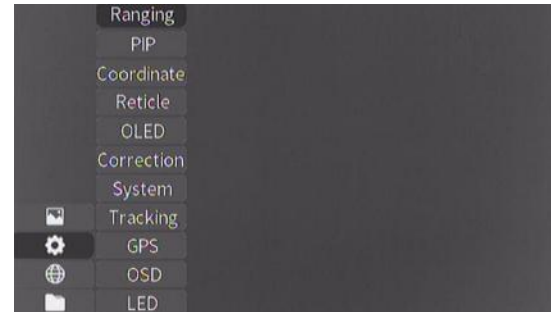

Image Setting		
Mode	Object mode	Especially enhance target' s detail. It' s recommended to be used in bad weather conditions.
	WDR mode	Gain both background and target' s detail with wide dynamic algorithm.
Sharpness	0-10	Adjust image sharpness to make the image edge sharper. The recommended value is 5.
Denoise	0-10	Adjust image noise to make the image cleaner. The recommended value is 5.
Brightness	1-10	Adjust image brightness to make the image brighter. The recommended value is 5.
Contrast	1-10	Adjust image contrast to make the target more prominent in the image. The recommended value is 5.

System Setting		
EIS		Electronic Image Stabilization. Can be turned on/off in the system setting.
Ranging	AI	AI distance measurement
	MIL	MIL distance measurement
PIP	Picture-in-picture	In the picture, the image is 2x enlarged from the center of the cross.

Coordinate		The position of the crosshair in the picture can be adjusted and separately saved.
Reticle	0-7	Choose the style of the crosshair. “0” represents none, and “1-7” represents seven different styles.
OLED	Hue	Blue, purple and gray are optional for OLED hue.
	Brightness	
Correction	Manual/ Auto	The mask works to calibrate the uniformity of images.
System	Reset	All configuration parameters are restored to the factory default values after resetting.
	Update	You can adjust and upgrade the device system.
	Language	Support multiple languages.
	Time zone	Select local time zone and adjust the date and time.
	Blind pixel	The blind pixel in the picture can be replaced.
Heat Tracking		Turn on heat tracking to mark the target with the highest temperature in real time in the screen.
GPS		Turn on GPS function to obtain real-time satellite positioning, longitude and latitude coordinates and time information.
OSD		Turn off OSD.
LED		Turn off LED. The work indicator is turned off and the hidden work mode is started.

EIS function: Turn on the EIS function to reduce the impact of body shaking on the image and keep the image stable when observing distant targets.

**Note: EIS function is only available for CP635/CP650.**



### 3.4.3 Network Connection

Press  to enter the Network Connection menu.

### 3.4.3.1 APP Download

Search "Smart Thermal" in APP store, or scan the below QR code to download the APP.

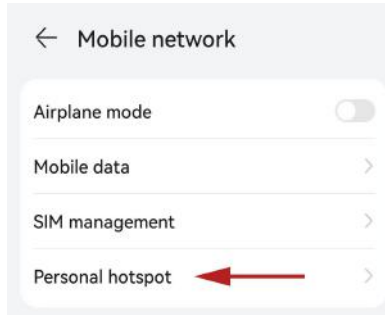

3.4.3.2 ①

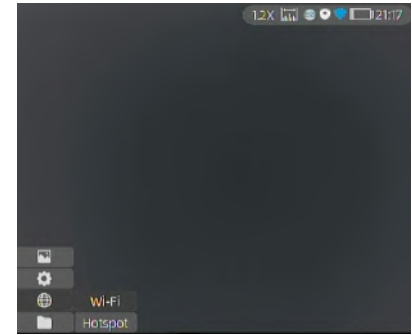

3.4.3.2 ②

### 3.4.3.2 Connect via Wi-Fi

① Open smart device' s personal hotspot.

② Short-press the rocker button to enter the sub-menus of Network Connection, and select WIFI for configuration.

③ Access the Wi-Fi sub-menu on monocular and select the Wi-Fi released by smart devices, and then enter the password through the rocker button to connect the Wi-Fi.

④ After the monocular is connected via Wi-Fi, open the mobile APP to connect the monocular.

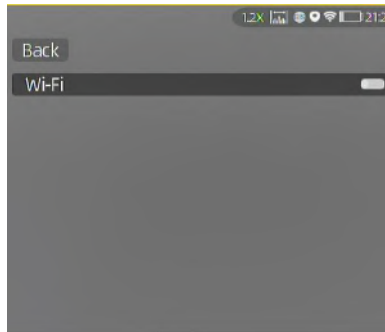

3.4.3.2 ③

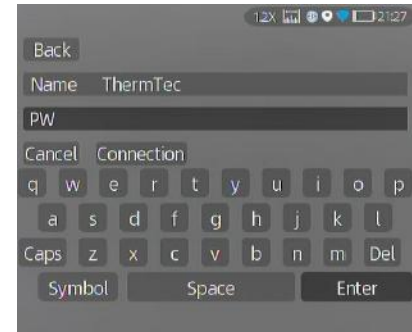

3.4.3.2 ④



### 3.4.3.3 Connect via Hotspot

① Short-press the rocker button to enter the sub-menus of Network Connection, and select WIFI for configuration.

② Access the Hotspot sub-menu, and the monocular will release a hotspot network. Set the hotspot name and password and confirm them through the rocker button.

③ Enable mobile device to connect with monocular Hotspot by setting the WLAN on mobile device.

④ After mobile device is connected with monocular Hotspot, open the mobile APP to connect the monocular.

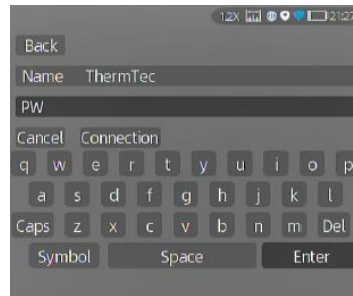

3.4.3.3 ③



3.4.3.3 ④

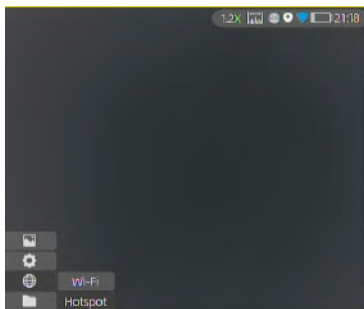

3.4.3.3 ①

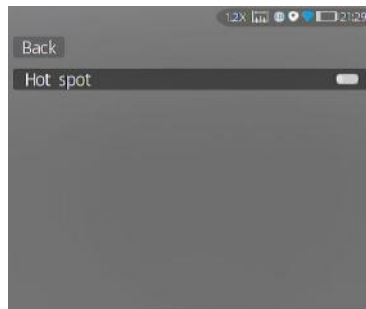

3.4.3.3 ②

### 3.4.4 APP Push Notification

The APP push notification function can detect and identify the target type (human or animal) in real time, measure the distance, and pop up a push notification on the APP.

The specific operation steps are as follows:

Note: Android phones can get push notification always on display by launching the APP in the background.

(1) Turn on AI and ranging function on the device.

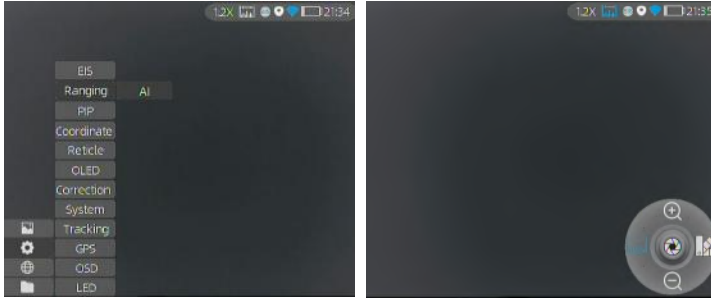

(2) Connect the APP with the device (follow Section 3.4.3). Select “Alarm” and “Open” to turn on the push notification.



### 3.4.5 File Management

Short-press  to enter the File Management menu. Select the image and video sub-menus to view the images and videos and play the videos.

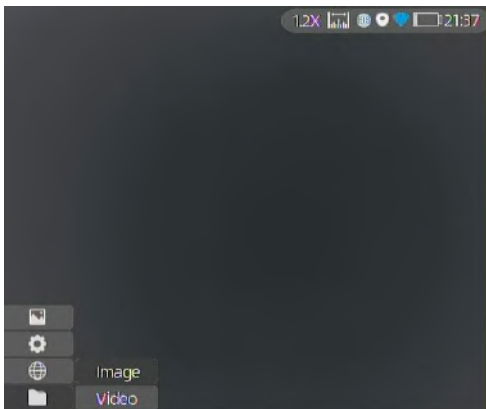

Power on the device before using a type-C to AV video cable to output analog video. When external display is connected, the OLED of the device automatically turns off the display.

Power on the device, use a type-C to USB cable to connect with the computer to read the video and image data in the memory.

Note: video and image taken in analog format (usually taken by external display with analog output) will be saved in folder named “720” , video and image directly taken by monocular will be saved in folder named “1024” .

File Setting	
Image	Access the Image sub-menu, and select photo files through the rocker button for management.
Video	Access the Video sub-menu, and select video files through the rocker button for management.

### 3.5 External Video & Data Reading

### 3.6 System Software Upgrade

- ① Connect the device to your computer and drag the upgrade file to the folder.

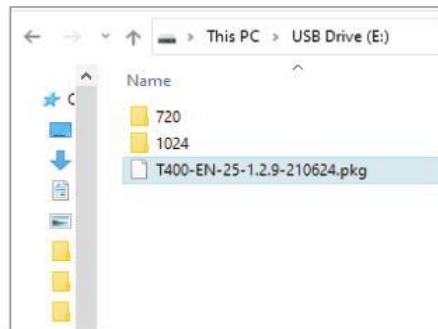

3.6 ①

- ② Access the Setup menu and select Upgrade.
- ③ The system will prompt that upgrading is in progress. When the upgrade succeeds, the device will restart automatically.

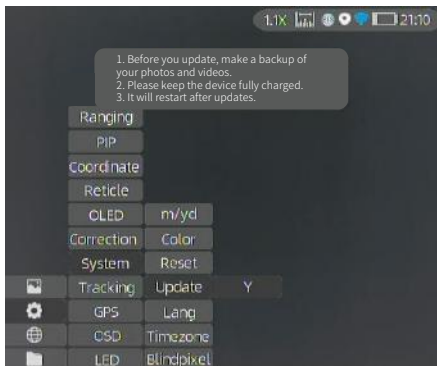

3.6 ②



3.6 ③

# 4

## Technical Data

### 4.1 Dimensions

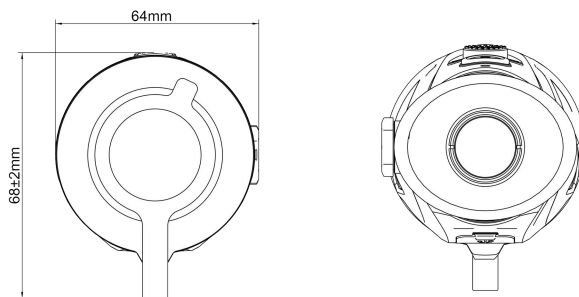
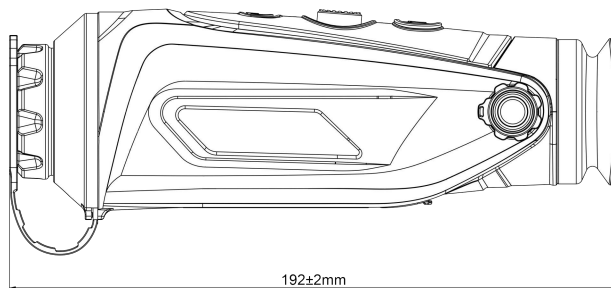

## 4.2 Specifications

Type	CP315	CP319	CP325	CP335	CP350	CP635	CP650
<b>Sensor Parameters</b>							
Detector Type	Vox Microbolometer						
Resolution/ Pixel Pitch	384 x 288/12μm					640 x 512/12μm	
NETD	≤40mk@300k					≤35mk@300k	
Frame Rate	8-14μm						
Spectral Range	50Hz						
Lens	15mm (F/0.9)	19mm (F/1.0)	25mm (F/1.0)	35mm (F/1.0)	50mm (F/1.0)	35mm (F/1.0,)	50mm (F/1.0)
FOV	17.5° x 13.1°	13.8° x 10.4°	10.5° x 7.9°	7.5° x 5.6°	5.3° x 4.0°	12.5° x 10°	8.8° x 7.0°
Magnification	1.4X	1.8X	2.4X	3.3X	4.8X	2.0X	2.8X
<b>Imaging Processing</b>							
Digital Zoom	1 - 6X continuous zoom						
Color Palette	5+						
Noise Reduction	3D noise reduction						
Image Enhancement	IDE; HDR						
<b>Display</b>							
OLED	0.39 inch; 1024x768 resolution						
Diopter Control	-5~+5						
Eye Distance	40mm						

<b>Function</b>	
OLED	3 modes
Language	English
Reticle	6+; adjustable coordinates
Memory Card	16G
AI Distance Measurement	Yes
Photo, Record, Playback	Yes
Heat Track	Yes
Lasor Indicator	Yes
GPS	Yes
<b>Power</b>	
Battery Type	Internal Cell (18650 x 2)
Battery Life	Continuous working time ≥12h
<b>Interface</b>	
Type-C	Power charge; data reading; output analog video
Wi-Fi	Two-way Wi-Fi connection; APP remote control
<b>Environmental Parameters</b>	
Working Temperature	-20°C~+55°C
Protection Level	IP67, 1 meter drop resistance
<b>Physical Parameters</b>	
Weight	470g (with battery)
Size	67mm x 63mm x 190mm
<b>Accessories</b>	
External Cable	Analog video cable; USB data cable
Other Accessory	Wrist strap; plush bag; user manual